

# Increasing the Trafficability of Unmanned Ground Vehicles through Intelligent Morphing

Siddharth Odedra<sup>1</sup>, Dr Stephen Prior<sup>1</sup>, Dr Mehmet Karamanoglu<sup>1</sup>, Dr Siu-Tsen Shen<sup>2</sup>

<sup>1</sup>Product Design and Engineering, Middlesex University  
Trent Park Campus, Bramley Road, London N14 4YZ, U.K.  
s.odedra@mdx.ac.uk  
s.prior@mdx.ac.uk  
m.karamanoglu@mdx.ac.uk

<sup>2</sup>Department of Multimedia Design, National Formosa University  
64 Wen-Hua Road, Hu-Wei 63208, YunLin County, Taiwan R.O.C.  
stshen@nfu.edu.tw

**Abstract** *Unmanned systems are used where humans are either unable or unwilling to operate, but only if they can perform as good as, if not better than us. Systems must become more autonomous so that they can operate without assistance, relieving the burden of controlling and monitoring them, and to do that they need to be more intelligent and highly capable. In terms of ground vehicles, their primary objective is to be able to travel from A to B where the systems success or failure is determined by its mobility, for which terrain is the key element. This paper explores the concept of creating a more autonomous system by making it more perceptive about the terrain, and with reconfigurable elements, making it more capable of traversing it.*

**Index Terms** *reconfigurable robotics, reconfigurable mechanisms.*

## 1. INTRODUCTION

Unmanned systems are designed to be used in dangerous situations where humans are either unwilling or unable to operate. These situations can occur in any environment such as on the ground, in the air, under the sea and even out in space. Each environment has a range of conditions and obstacles which make it difficult for the unmanned system to operate in, for example wind speed is a key issue for the Unmanned Aerial Vehicle (UAV), as is keeping electronic components from getting wet for the Unmanned Underwater Vehicle (UUV); however the Unmanned Ground Vehicle (UGV) has the hardest job in terms of navigating in its environment. This is because ground conditions include a number of different obstacles, both positive and negative, over a range of different terrain types and UGV's generally have to operate in unknown, unstructured environments which include a large number of unpredictable and dynamic variables, making the seemingly simple task of traversing very hard. They therefore need to be extremely capable and have a very high degree of mobility in order to complete their missions.

## 2. UNMANNED GROUND VEHICLES

Unmanned Ground Vehicles can be defined as mechanised systems that operate on ground surfaces and serve as an extension of human capabilities in unreachable or unsafe areas. They are used for many things such as cleaning, transportation, security, exploration, rescue and bomb disposal. UGV's come in many different configurations usually defined by the task at hand and the environment they must operate in, and are either remotely controlled by the user, pre-programmed to carry out specific tasks, or made autonomous.

An example of a UGV used in an unsafe and unreachable area, is the space exploration rovers currently searching for signs of life on the surface of the planet Mars, where conditions are too harsh for humans with no oxygen or source of food, and with no need or means to return to Earth, the rovers can be left there after the mission [1].

The largest sector to employ and fund the development of UGV's is the security and defence industry, who deploy a range of systems for various missions ranging from bomb disposal to reconnaissance. The military use UGV's to carry out dangerous missions because the warzone is one of the most hostile environments on the planet and if a robot can replace a soldier and gets damaged or destroyed then it is a far smaller price to pay than to risk a human life.

iCasulties.org [2] reports that up until November 2008, the Iraq war has seen 4,201 coalition fatalities with 1812 (43%) caused by Improvised Explosive Devices (IED's); making IED's the biggest killer in the Iraq war; this is why one of the biggest areas UGV's are used for is bomb disposal or Explosive Ordnance Disposal (EOD).

### 2.1. The Remotec Wheelbarrow Revolution UGV

One of the most successful EOD systems used worldwide is Remotec's Wheelbarrow Revolution (Fig.1) whose motto is 'keeping danger at a distance'.



Fig. 1. Remotec's Wheelbarrow Revolution UGV.

The Wheelbarrow Revolution is a remotely controlled tracked UGV with good vehicle mobility and stability over rough terrain and a manipulator arm which has a good reach and the possibility to carry a number of payloads. This system has been used for many bomb disposal missions worldwide but the most publicised one was in June 2007, when the UGV was used to successfully inspect and dispose of various suspect packages after a car bomb was discovered outside the 'Tiger Tiger' night club in Haymarket, London (see Fig.2).

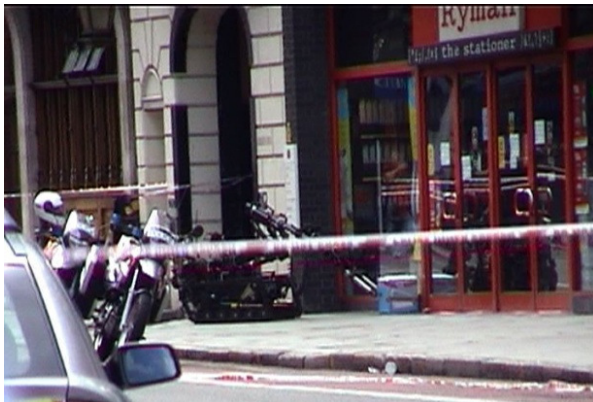

Fig. 2. Wheelbarrow Revolution inspecting a suspect package

### 2.2. iRobot Packbot UGV

Alongside EOD robots are another breed of rugged, highly capable UGV's used mainly in warzones by the U.S Army who need to be able to look and operate in unsafe or unreachable areas such as caves in Afghanistan or cluttered urban cities in Iraq. Two systems are used in today's battlefield, the first is the Packbot developed by iRobot (see Fig.3) which is the most successful UGV in today's military. It is a small man portable system with a number of payloads and iRobot report that more than 2000 systems have been delivered to the U.S Army for use in hostile areas in both Afghanistan and Iraq. iRobot currently have a \$51.4m contract which lasts till 2010 to supply them with a fleet of Small Unmanned Ground Vehicles (SUGV) as part of the

Future Combat Systems (FCS) program; and recently, on the 12<sup>th</sup> November 2008, iRobot reported that they have been awarded a further \$2m by the U.S Congress to develop the Warrior 700, their next generation robot [3].

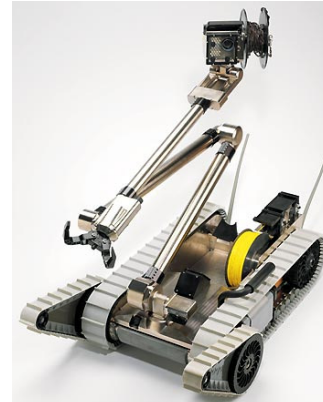

Fig. 3. The Packbot UGV developed by iRobot.

### 2.3. Foster-Miller TALON UGV

The second system used by the U.S Army is the TALON developed by Foster-Miller, a subsidiary of QinetiQ. This system is larger than the Packbot but is used for heavier mission payloads, the most controversial version being the SWORDS payload, which makes the TALON the first lethal, combat capable UGV with full weapon capability. Payload options include M16, M240 and M249 machine guns; a Barrett 50-calibre rifle; a 40mm grenade launcher, and a M202 anti-tank rocket system [4]. The latest TALON system is the Modular Advanced Robotic System (MAARS), which can be reconfigured to offer multiple mission payloads so that it can be used for more than just a weapons platform. It has a stronger chassis, it is heavier but faster, includes the option of a manipulator arm together with more weapon capabilities (see Fig.4).



Fig. 4. Foster-Miller's MAARS UGV.

## 2.4. Summary

These systems show examples of how unmanned systems are used to replace humans in dangerous situations ultimately saving lives especially on the battlefield, however these systems are all human operated and still require an operator, putting them close to the danger and taking extra human resource to maintain and control the system. This was realised by the U.S Defense Advanced Research Projects Agency (DARPA) who started a research and development program called the Grand Challenge in 2004, with the goal of developing autonomous system technology that will keep war-fighters off the battlefield and out of harms way [5].

## 3. GRAND CHALLENGES

*“The purpose of the DARPA Grand Challenge is to leverage American ingenuity to accelerate the development of autonomous vehicle technologies that can be applied to military requirements”* (DARPA, 2004)

The DARPA Grand Challenge 2004 was a field test that required unmanned autonomous robotic ground vehicles to successfully navigate a course through the Mojave Desert in March 2004. The course covered approximately 142 miles of off and on-road terrain; the winning team would receive \$1 million, which would have been the team that completed the course in less than the 10-hour time limit. No one completed the course with the most successful system being Red Team’s vehicle Sandstorm from Carnegie Mellon, getting the furthest at only 7.4 miles where it went off-course at the tightest hairpin turn and got stuck on the embankment [6]. This event proved how hard making a vehicle fully autonomous actually is, but after this very unsuccessful event, DARPA didn’t give up and organised another event for 2005 and this time the winner would receive a \$2m prize.

The second challenge was held in October 2005 and had the same rules, location and time limit but the distance was decreased to 132 miles, and the prize had doubled. This time there was more success with five teams completing the course. The winning vehicle was Stanford Racing Team’s vehicle called Stanley, a commercial VW vehicle with added intelligence (see Fig.5), which completed the course autonomously in six hours and fifty-three minutes [7].

The DARPA Urban Challenge held in November 2007 was their latest competition. The rules were similar but this time the teams were required to build an autonomous vehicle capable of driving in traffic, performing complex manoeuvres such as merging, passing, parking and negotiating intersections. This event was truly groundbreaking as it was the first time that autonomous vehicles had interacted with both manned and unmanned vehicle traffic in an urban environment. After a qualification event it was announced that eleven teams were selected to compete. The event finished with six teams crossing the line, the winner being Tartan Racing, from Carnegie Mellon, Pittsburgh who demonstrated the best autonomous behaviour in following the Californian Road Regulations [8].

These Grand Challenges proved successful in bringing the best technology forward from a range of industries nationwide, which led to the Ministry of Defence (MoD) holding a similar event in the U.K also named the Grand Challenge. In October 2006 the MoD announced that they will hold the Grand Challenge competition open to anyone within the UK from top military developers to academia. The challenge was to create a system capable of autonomously navigating and detecting a range of threats within the urban environment. Threats included snipers, IED’s, military personnel and armed 4x4’s known as ‘technical’s’. The finale was held in August 2008 at Copehill Down Village on Salisbury Plain, a mock village used for military urban warfare training. Eleven teams made it to the final with various systems such as unmanned air vehicles, ground vehicles and a combination of both. After a gruelling two weeks of qualifying and competition, team Stellar came out on top and won the R.J. Mitchell trophy after their combined UAV/UGV system demonstrated the best autonomous identification of the threats [9].



Fig. 5. ‘Stanley’ – the winner of the second DARPA Grand Challenge.

## 4. UGV DEVELOPMENT AREAS

The Committee on Army UGV Technology [10] discuss how there are six main UGV development areas which need investigation, these being Mobility, Communications, Health Maintenance, Human-Robot Interaction, Autonomy and Power. While ubiquitous developments are ongoing for all the areas, most of them are currently at the state of the art apart from autonomy which is the ultimate goal for all UGV’s, because the more the UGV can do by itself then the less a human has to be put in harms way to command it, and this is why various military research organisations have set challenges to drive technology in this area forward. Fig.6 displays the evolution of robotic development according to the US Secretary of Defense [11], and supports the fact that autonomy will be an integral part of tomorrow’s systems, with fully autonomous systems expected to be a reality by 2020.

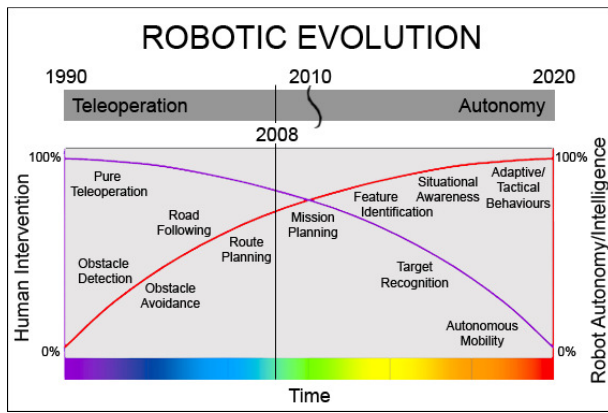

Fig. 6. The evolution of robotics in terms of autonomy.

#### 4.1. Autonomy

The development into creating autonomous systems can be split into sub-sections. These are Planning, Perception, Behaviour Skills, Navigation and finally Learning/Adaptation. Of all these areas, perception is the most important in making an autonomous system and is vital to autonomous A to B mobility. The Committee on Army UGV Technology have stated that perception is a very important area in the development of autonomous systems as a UGV's ability to perceive its surroundings is critical to the achievement of autonomous mobility. Perception heavily relies on the systems ability to sense and interpret information about the environment and Newman's [12] research review on Robotics and Cognition states that without sensors and data-fusion algorithms, the development of autonomous systems remains in the realms of science fiction. However, once the system becomes highly perceptive and becomes more knowledgeable about its local environment, then it needs to decide what to do next. UGV's can only carry out tasks using the hardware available to the system, and even though this hardware gives the system the capabilities to carry out specific tasks, it also means that it is limited to these tasks. This is important when looking at a UGV's mobility, because the primary objective of any mission for a UGV is to be able to successfully drive from A to B and to do this they must not only be more perceptive but they must have a high degree of mobility.

#### 4.2. Mobility

Mobility, in robotic terms, can be defined as the vehicles ability to transverse over a type of terrain (its trafficability), or how it copes with obstacles. The Committee on Army Unmanned Ground Vehicle Technology [10] discuss how the U.S. Army state that a UGV must have a high degree of mobility because:

- a high degree of mobility minimizes the perception burden,
- timely mission accomplishment cannot be achieved if the platform has to spend its time searching for an easy path through difficult terrain,

- the best route for covert missions will most likely not coincide with the easiest mobility route,
- a high degree of mobility will keep the vehicle from becoming stuck, thus requiring less human assistance.

The MoD shares the view that a vehicle with higher mobility characteristics is more capable. Table 1 displays the specifications for vehicles under 4 tonnes (manned or unmanned) set in Defence Standard 23-06 to help categorise mobility levels. This information catalogues current vehicles mobility capabilities and also helps dictate how future vehicles can be designed to be more mobile.

TABLE I  
DEFENCE STANDARD 23-06 ISSUE 4 - MOBILITY SPECIFICATIONS

Vehicles <4 tonne	HMLC	IMMLC	MMLC	ILMLC	LMLC
Ground pressure, (MMP in kPa)	< 280	280-350	350-550	550-700	>700
Minimum ground clearance (mm)	400	260	180	150	115
Minimum approach angle (degrees)	45	40	40	35	n/a
Minimum departure angle (degrees)	40	38	38	30	n/a
Maximum under vehicle angle (degrees)	130	155	155	155	n/a
Minimum stability tilt angle (degrees)	35	33	30	28	28
<b>Abbreviations:</b> MMP - Mean Maximum Pressure HMLC - High Mobility Load Carrier IMMLC - Improved Medium Mobility Load Carrier MMLC - Medium Mobility Load Carrier ILMLC - Improved Low Mobility Load Carrier LMLC - Low Mobility Load Carrier					

As mentioned earlier, UGV's as well as all robots, are only as capable as the hardware they possess and that includes mobility capabilities which are dependant on the vehicle's drive system and even though there are others, currently there are three main types.

4.2.1. *Tracks*: The first kind are tracks which the majority of UGV's drive on, as seen previously in the review of current systems; and this is because they offer the best mobility where there will be rough, uneven surfaces. Tracks are mainly used for off-road locomotion because they 'make their own road' which provides greater traction and can drive over uneven, sinking ground because they can distribute the vehicles weight more evenly over a larger

surface area creating a lower ground pressure. An example of this is how the 62.5 tonne Challenger 2 Main battle tank used by the British Army has a ground pressure of only 88 kPa, compared to an average road car which at less than 2 tonnes has a ground pressure of over 100 kPa [13]. Another advantage with tracks is that they are skid steered which means they can turn on their axis making them very manoeuvrable. However, tracks have their disadvantages, they are high power consumers, noisy, inefficient, cause a lot of vibration, and have relatively low top speeds on flat road surfaces. Finally, with tracks being made up of a number of moving parts this means that there is more to go wrong.

**4.2.2. Wheels:** Next are the wheeled systems, which possess attributes opposite to tracked systems: they are more power efficient, good for driving at high speed on flat ground and offer a comfortable ride; but are not the best mobility type for off-road because they can become stuck when driving over uneven ground and can be prone to sinking as they can induce a high ground pressure due to their low contact surface area. Another disadvantage with wheels is pneumatic tyres, which can render a vehicle useless if there is a puncture, and in terms of military applications this would be fatal to the mission.

**4.2.3. Legs:** Finally some developmental systems use legs because species that travel on legs such as humans, have a natural ability to efficiently cope with a wide range of terrain types from flat even ground to harsher environments [14]. Siegwart and Nourbakhsh [15] discuss the key advantage of legged systems to be their adaptability and manoeuvrability in rough terrain, which is because they only come into contact with the ground at minimal points therefore the quality of the ground under and between the points doesn't matter just as long as the system can maintain adequate ground clearance and stay balanced. Fig.7 shows an example of a legged system developed by Boston Dynamics, which is a Multifunctional Utility, Logistics and Equipment (MULE) robot known as the BigDog. It can run up to 4 mph, climb slopes up to 35 degrees and walk across rubble, all while carrying loads of up to 150 kg [16]. Disadvantages of legged vehicles are speed, power requirements, mechanical complexity and advanced systems required for control of balance and stability.

### 4.3. Summary

To summarise, perception is essential to autonomous operation however mobility is equally as vital because as previously discussed a high degree of mobility minimizes the perception burden, and the more mobile the vehicle is then the less likely it will become stuck. Systems are generally designed with specific hardware depending on what task they are to be used for; however they are then limited to that use. This was realised by Foster-Miller that by giving their TALON robot the SWORDS combat payload it limited it to combat missions, they then developed the MAARS version discussed earlier, which is a modular system capable of switching payloads, in order to offer more

options. The same goes for mobility hardware, if specific types are selected then it could limit where they can go.

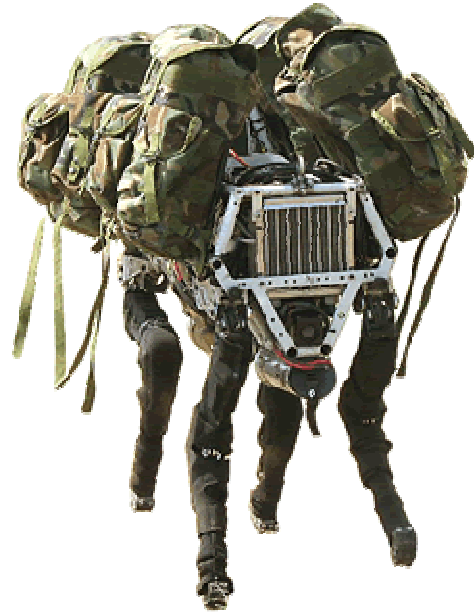

Fig. 7. BigDog - Boston Dynamic's legged UGV.

## 5. DISCUSSIONS AND CONCLUSIONS

Unmanned systems are only effective if they can perform as good as, if not better than a human in the same situation. They must possess full capabilities and operate with a high degree of accuracy. The primary objective of any mission for a UGV is to be able to successfully drive from A to B and to do this they must have a high degree of mobility. For autonomous operation, perception is very important in gathering information about the local environment so the system can make decisions on its next move. These decisions are dependant on the hardware available and the limitations of the systems capabilities.

This is a parallel, two part problem in every developmental area of all unmanned systems. Part 1 of the problem is that a higher degree of perception must be developed to create more knowledgeable systems. Simultaneously, Part 2 is that the system must have increased capabilities in order to decrease its limitations. Together these developments will create a more autonomously capable system. In terms of UGV mobility, for Part 1 the system needs to have increased perception of the key elements pertaining to the vehicles mobility, which is the terrain type and environment. At the same time for Part 2 the mobility hardware needs to be more capable to increase the vehicles' ability to traverse terrain.

### 5.1. Part 1 - Increased Terrain Perception

Terrain is an important element in autonomous driving because if a vehicle cannot travel over a certain terrain type and does not know this, then it will become stuck and

ultimately fail its mission, as seen in the first DARPA Grand Challenge. There are two ways of tackling this problem: There can be non-intelligent systems that are built to cope with a lot of different terrain types, such as tracked or large 4x4 vehicles that can drive over almost any rough terrain but if it was to become stuck then it would fail; therefore, for autonomous solutions it is best to give the vehicle increased perception with the ability to sense the terrain.

Current systems use a range of passive sensors (such as 3D Sick laser scanners, cameras, infrared or ultrasonic sensors) to gain information about the environment and help build a 3D map of the area. These vision and radar systems look ahead at the terrain and make decisions on what is seen, which will give an idea of what the terrain type is by deciding on what it might be from its appearance; but this isn't necessarily an accurate picture as to what the vehicle will actually encounter.

To be able to sense the terrain, we must first understand what is happening at the interaction between the vehicles' drive system (wheels, tracks or other) and the ground [17]. Iagnemma and Dubowsky [18] look at a wheeled system and consider how there are four different interface scenarios:

- a deformable wheel on a rigid terrain
- a rigid wheel on a rigid terrain
- a rigid wheel on a deformable terrain
- a deformable wheel on a deformable terrain

They discuss that, in simple terms the most important factors that affect the vehicles' performance across terrain are sinking and slipping, and focus on the rigid wheel on deformable terrain scenario (see Fig.8). This is because firstly UGV's rarely consist of deformable wheels, which are representative of pneumatic tyres, because if they become punctured the mission would be over; and secondly a rigid wheel on a rigid terrain would only have slip issues, which even though inefficient, would not cause the vehicle to become stuck and fail its mission.

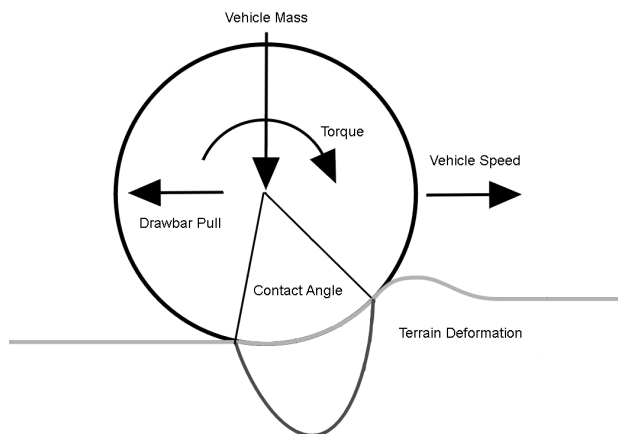

Fig. 8. Interaction of a rigid wheel on deformable terrain.

This demonstrates that the rigid wheel on a deformable terrain scenario is the most likely to cause a vehicle to fail its mission. The two main elements discussed earlier that potentially dictate a vehicles ability to traverse deformable terrain, are slipping and sinking, therefore an autonomous system would need the ability to measure both, to have an increased perception of the wheel-terrain interface. Wheel slip or vehicle slippage (the amount of slip) can be determined by measuring the vehicles speed and the wheels angular velocity. Sinking or sinkage (sinking amount) is more complicated and has two factors: flotation (the terrains ability to support a vehicle) and ground pressure (the pressure exerted on the ground by the vehicle). Flotation is a characteristic of the terrain and cannot directly be measured, whereas ground pressure is a characteristic of the interaction and can be calculated from the vehicles weight (which is fixed) and the contact surface area (which could be varied). This shows that contact surface area is a key factor in determining sinkage.

We propose that to sense the terrain, the system must use active contact sensors to take measurements of the drive systems' slippage and sinkage, which are conditions of the wheel-terrain interface; giving real-time information on what is actually happening at the physical interaction.

These contact sensors are not to replace the other sensors as each sensor has its own job and capability, this concept is to be put in place to compliment the current sensors in service to be part of a three-phase system. Phase one will use previously gathered data about the environment from sources such as reconnaissance images, Google Maps or long range sensors, for example satellite images or data sent back from 'look ahead' UAV's; this information will be used to determine what will happen before getting there. Phase two will be medium range sensing, using data from an array of passive sensors to look ahead to determine what is going to happen next in order to help make decisions on the immediate future. Finally, phase three, which is real-time data from the contact sensors telling the system what is happening right now so that the system can monitor and make changes at the interface if need be.

## 5.2. Part 2 - Increased Mobility Capability

Once the system has real-time information on what is actually happening at the vehicle-terrain interface, there are two decisions the autonomous system can make (see Fig.9). The first, which is a process that all current systems follow, is to detect that the vehicle cannot cope with a certain terrain type and therefore avoid it to prevent getting stuck; creating a system limited to where it can go and a system that needs to spend time finding a safe path. The second solution, which is the second part of our proposal, is a system that can sense the terrain and then have the ability to 'morph' or reconfigure its drive system in order to adapt to situational changes, which would ultimately create a versatile system with increased trafficability and less limitations as to where it can go [19].

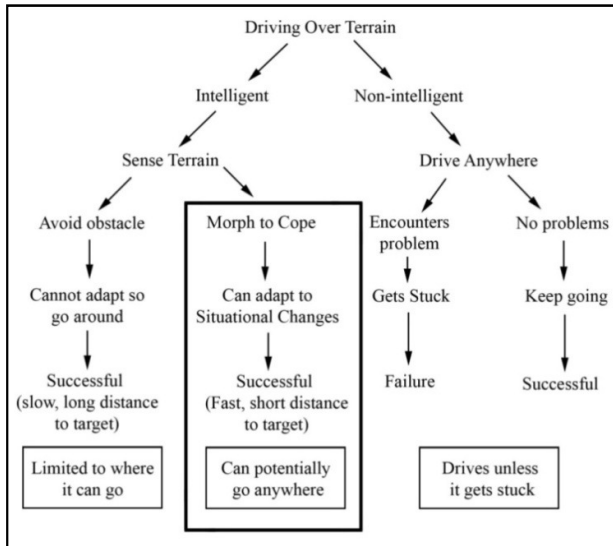

Fig. 9. The different ways in which to traverse terrain.

The concept of having adaptive drive systems has been around for a while, a simple example is traction control or ABS which allows the vehicle to adapt to situational changes. This concept was also realised by off-road vehicle manufacturers who discovered that no one single drive setting can cope with the differences in ground types and therefore there is a need to have different configurations in order to successfully traverse different terrain types; an early example of this was the birth of switchable 4-wheel drive systems. Many other developments have gone into off-road vehicles since then but the best demonstration of a system that can be reconfigured to cope with changes in ground conditions is the Terrain Response System available on the latest Land Rover Discovery, which allows the driver to select the type of configuration via an in-car dial in reference to the terrain type that they are about to travel over.

So what can a UGV change once the system has information on what's happening at the wheel-terrain interface? The next stage is for the system to ask if it is stuck or not, if not then the system can carry on, however if or when the system detects that it has become stuck because it is slipping, sinking or both, the next question is, what

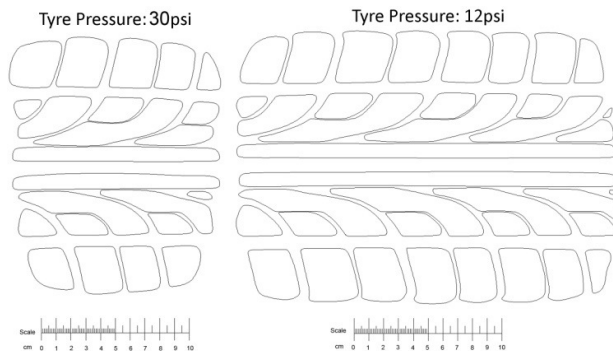

Fig. 10. Test of how tyre pressure changes its contact surface area.

can be adjusted to help the vehicle carry on with its mission? The obvious factors that could be adjusted are those that are used to classify how mobile a vehicle is, such as those dictated by the MoD in defence standard 23-06 (see Table 1), such as ground clearance, approach, under vehicle and departure angle. However, the most important condition that needs to be reconfigurable is contact surface area. This is because the contact surface area is the common driving factor that dictates the vehicles' ground pressure (which is also stated in Table 1 as a factor of how mobile a vehicle is), together with traction, and these are the two elements pertaining to sinkage and slippage.

To prove this some early tests were carried out on a commercial road vehicle to see how the difference in tyre pressure affects its contact surface area (Fig.10), and in turn its ground pressure. The results can be seen in Fig.11, which shows that as the tyres' contact surface area increases its ground pressure decreases; proving that a system with the ability to reconfigure or 'morph' its drive system in order to adjust its contact surface area (affecting its ground pressure), can be more capable and successful on and off-road, creating a more dynamic, versatile, terrain capable system with increased trafficability and the potential to drive anywhere.

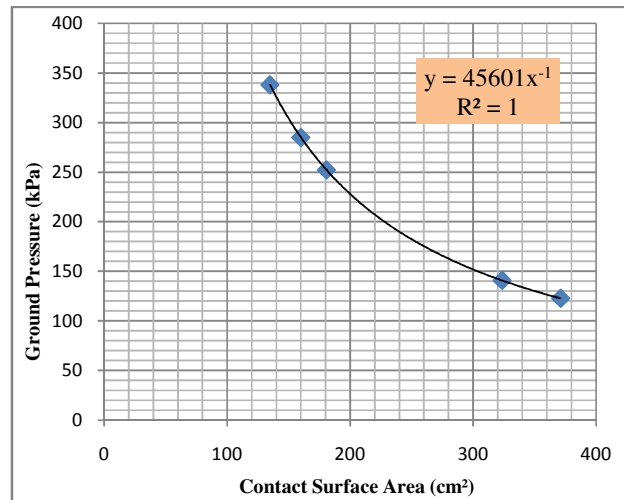

Fig. 11. Test results showing how the contact surface area affects the ground pressure.

## 6. FURTHER WORK

A couple of issues have been highlighted with this system. The first is how does the system know what is the best setting for its current situation, does it have a preloaded set of data informing the system what configuration should be used for different scenarios; or does the system select the best way to traverse different terrain types by learning from past encounters of traversing terrain with similar characteristics.

The second issue is that this method is detecting the vehicles present situation at the interaction and it can be

argued that if you are stuck it is too late to sense the terrain, however if the vehicle can morph to get itself unstuck it is only a matter of time and power consumption and not something that will cause mission failure. The ideal system would be one that can look ahead and remotely detect the terrains' properties to work out its flotation, and then choose the best configuration before getting there. To do this, the terrain needs to be understood for which there is a vast amount of information available on terrain (soil) types and a whole science of terrain and ground types (known as Terramechanics).

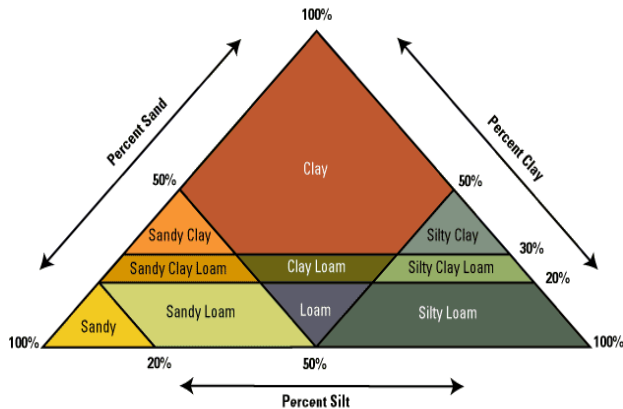

Fig. 12. Triangle of soil types.

Terrain (soil) consists of a number of elements; natural terrain is made up of a mixture of three particles, soil, silt and sand [20]. The percentage of each of these dictates what type of terrain it is as seen in Fig.12. Other factors effecting terrain properties are particle size and the elements that fill the voids in between particles, which is either air, water or ice. These factors greatly affects the terrains' properties, sand for example, has very small particles and has very different properties when wet compared to when dry, which in turn affects the ability of that terrain to support a vehicle; therefore the key elements that dictate terrain properties are particle size and the percentage of water content. Future work will be conducted to remotely measure these properties in real-time to help predict the terrain ahead, which could create a dual system that could look ahead and estimate the terrains' ability to support the vehicle.

## REFERENCES

- [1] Space.com. *All about Mars*. 2008. Available from: <http://www.space.com/mars/>.
- [2] iCasualties.Org. *Iraq Coalition Casualty Count: IED Fatalities*. 2007. Available from: <http://www.icasualties.org/oif/IED.aspx>.
- [3] iRobot. *Congress Allocates \$2 Million for iRobot to Develop its Next - Generation Robotic Platform Warrior 700*. 2008. Available from: <http://www.irobot.com/sp.cfm?pageid=86&id=433&referrer=28>.
- [4] Foster-Miller. *TALON Brochure*. 2008. Available from: [http://www.foster-miller.com/literature/documents/TALON-Brochure.pdf#talon\\_brochure](http://www.foster-miller.com/literature/documents/TALON-Brochure.pdf#talon_brochure).
- [5] DARPA. *What is the Urban Challenge?* 2008. Available from: <http://www.darpa.mil/GRANDCHALLENGE/overview.asp>.
- [6] Vance, A. *DARPA's Grand Challenge proves to be too grand*. 2004. Available from: [http://www.theregister.co.uk/2004/03/13/darpas\\_grand\\_challenge\\_proves/](http://www.theregister.co.uk/2004/03/13/darpas_grand_challenge_proves/).
- [7] Orenstein, D. *Stanford team's win in robot car race nets \$2 million prize*. 2005. Available from: <http://news-service.stanford.edu/news/2005/october12/stanleyfinish-100905.html>.
- [8] DARPA. *CMU's Tartan Racing Wins Urban Challenge*. 2008. Available from: <http://www.darpagrandchallenge.com/>.
- [9] Randerson, J. *Military technology: MoD announces winner of robot challenge*. guardian.co.uk. 2008. Available from: <http://www.guardian.co.uk/science/2008/aug/19/grand.challenge.weapons>.
- [10] Committee on Army Unmanned Ground Vehicle Technology, N.R.C., *Technology Development for Army Unmanned Ground Vehicles*. 2002.
- [11] U.S. Secretary of Defence (2005). *Unmanned Aircraft Systems Roadmap 2005-2030*, Secretary of Defence for Acquisition, Technology and Logistics.
- [12] Newman, P., Tarassenko, L. (2004). *Foresight Cognitive Systems Project Research Review: Robotics and Cognition*. UK, The Office of Science and Technology.
- [13] British Army. *Challenger 2 Main Battle Tank*. 2008. Available from: <http://www.army.mod.uk/equipment/fighting-vehicles/1475.aspx>.
- [14] Spagna, J.C., Goldman, D.I., Lin, P.C., Koditschek, D.E., Full, R.J., *Distributed mechanical feedback in arthropods and robots simplifies control of rapid running on challenging terrain*. *Bioinspiration and Biomimetics*, 2007. 2 : p. 9-18.
- [15] Siegwart, R., Nourbakhsh, I.R., *Introduction to Autonomous Mobile Robotics*. 2004, Cambridge: The MIT Press.
- [16] Boston-Dynamics. *BigDog*. 2008. Available from: <http://www.bostondynamics.com/content/sec.php?section=BigDog>.
- [17] Bekker, M.G., *Introduction to Terrain-Vehicle Systems*. 1969, Ann Arbor: The University of Michigan Press.
- [18] Iagnemma, K., Dubowsky, S. *Terrain Estimation for High-Speed Rough-Terrain Autonomous Vehicle Navigation*. in *SPIE Conference on Unmanned Ground Vehicle Technology IV*. 2002.
- [19] Odedra, S., Prior, S.D., Karamanoglu, M. *Towards Solving the Mobility Issues of Unmanned Ground Vehicles*. in *Unmanned Systems Technology IX*. 2007. World Marriot Resort and Convention Center; Orlando, Florida USA: SPIE.
- [20] Muro, T., O'Brien, J., *Terramechanics. Land Locomotion Mechanics*. 2004, Tokyo: A.A. Balkema Publishers.