

Development of a Biosensor for fast point-of-care Blood Analysis of Troponin

Bayford R, *Life Senior Member, IEEE*, Damaso R, Jiang D, Rahal M, Demosthenous A, *Fellow, IEEE*

Abstract—We present the development of novel tetrapolar EIS biosensor for the detect of troponin. Troponin has considerable diagnostic power and provide invaluable prognostic information for risk stratification. of acute coronary syndromes. *Clinical Relevance*— A feasibility study was undertaken to assess the diagnostic performance of serial cardiac troponin measurements which is excellent as these structural proteins are unique to the heart and thus sensitive and specific of damage to the myocardium. clinical molecular diagnostics and home healthcare. Troponin’s biosensors would provide point-of-care and rapid decision making for the early detection of CS. Clinically relevant window of cTnI testing, concentrations from 10pM to 0.1μM were achieved.

I. INTRODUCTION

Troponins are recognized as one of the most specific and sensitive biomarkers for the diagnosis and prognosis of acute coronary syndromes (CS) [1]. Troponins have a considerable diagnostic power and provide invaluable prognostic information for risk stratification. The diagnostic performance of serial cardiac troponin measurements is excellent as these structural proteins are unique to the heart and thus sensitive and specific of damage to the myocardium. Changes in these proteins can be measured early in on set of CS and can identify high-risk patients much sooner than other methods. Most CS testing takes place in Hospital laboratories. However, biosensors have gained popularity over the last two decades due to the growing need to reduce the analytical footprint of laboratory-based instruments. There is a clear need for clinical molecular diagnostics and home healthcare Troponin’s biosensors would provide point-of-care and rapid decision making for the early detection of CS.

While EIS sensors stand-out due to their performance, there were issues with the reported biosensors. [1] These included, but not limited to decreased specificity in serum [4], sample processing requirements [5] and performance decrease after storage [6]. This is due to most EIS biosensors using two or three electrodes which requires a redox solution for measurement. To avoid using an external redox solution, few try to use internal redox probes [7] or measure capacitance [8], however those achieve poorer sensitivity. Instead, the electrode cell can be modified to a four-electrode array

(tetrapolar), which is used in other electrochemical fields such as electrochemical impedance tomography (EIT), however it is not widely applied for EIS sensors. Tetrapolar detection is not affected by the impedance of the electrodes’ surface, and thus does not require redox. Tetrapolar uses a novel four electrodes method. The outer two inject a constant current while the inner two electrodes measure the voltage gradient. The electrodes spacing can adjust the sensitivity at different distances above the electrodes to allow the maximin sensitivity of the analytical layer. Only one report on a tetrapolar EIS biosensor could be found for detecting the Alzheimer’s disease-related tau protein, and the biosensor achieved a very low sensitivity (LOD = 1.37 pg/ml) and very good specificity [10]. To date, no tetrapolar EIS biosensors have been reported for cardiac troponin I detection.

In this paper we present the development of novel tetrapolar EIS biosensor for the detect of troponin.

II. METHOD

A. Materials

The gold microband electrodes and connector (ED-AIO-CELL) were custom fabricated by MicruX Technologies (Spain), the cyclic voltammetry was platform with a EEP-AIO-CELL, and a silver/silver chloride (Ag/AgCl) reference electrode. Phosphate buffer saline (PBS-D8537), ethanolamine (E0135), potassium hexacyanoferrate (II) trihydrate (455989) and potassium hexacyanoferrate (III) (244023) were purchased from Sigma Aldrich (UK). Cardiac troponin I antibody (PA528964) and cardiac troponin I ELISA kit (ETHNNI3) were purchased from Thermo Fisher Scientific (UK). Recombinant cardiac troponin I protein (ab207624), recombinant Protein G (ab73758) and 3,3’-dithiobis (sulfosuccinimidyl propionate) (DTSSP-ab145616) were purchased from Abcam (UK). Deionized water (Di-H₂O) used throughout experiments was maintained at >1 MΩ with a lab deionization unit (Select Analyst, SUEZ Water Technologies & Solutions, France).

B. Electrodes

The electrode array was designed based on upgrading previous work with the tau biosensor [10], where a four microband printed-circuit board electrode was used. In this work, the four microband array was designed with a glass substrate to reduce the cost per unit and allow the sensors to be disposable. The array was designed using computer-aided

This work was supported by National Institute for Health Research University College London Hospitals, grant No: BRC655/HEI/AD/110410.

Bayford, R with the Department of Natural Sciences, Middlesex University, London, UK. (correspondence e-mail: r.bayford@mdx.ac.uk).

Demosthenous A, Damaso R, Jiang D, Rahal M are with the Department of Electronic and Electrical Engineering, University College London, London, UK. (e-mail: a.demosthenous@ucl.ac.uk).

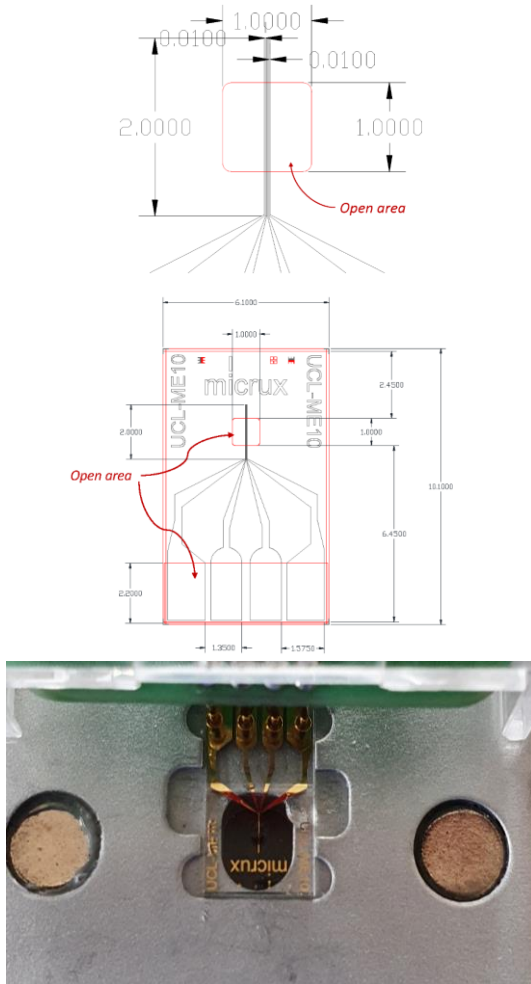

Fig. 1 Four-band gold electrode thin-film design fabricated by MicruX, Spain. Size in millimetres. Tetrapolar microarray after fabrication. The electrode array was placed onto a holder for easy connection with the FRA.

design (CAD) technology with the software AutoCAD (Autodesk®).

The electrode array consisted of four 10µm width microbands, with 10µm spacing pitch-to-pitch between each other (Fig 1). It was fabricated using standard thin-film microfabrication on a glass substrate, and each microband was composed of a 50nm thick titanium layer and a 150nm thick gold upper layer. The electrode surface was coated with an SU-8 passivation layer, except for an 1x1 mm window where 1mm length of the gold microbands was left exposed – forming the active area. The electrode array is 10.10 mm x 6.10 mm and has four open gold pads for connection. The microelectrode array was connected with a drop-cell connector where four pogo-pins are

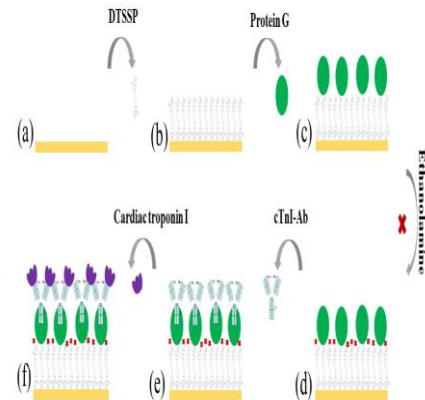

Fig 2 Cardiac troponin I immunosensor construction. To the (a)cleaned gold electrode, an aliquot of (b)DTSSP was added to the surface forming an ordered SAM. (c)Protein G was then added to the active area to form a bond with the SAM layer, followed by (d)blocking un-reacted sulfo-NHS groups with ethanolamine. (e)Anti-human cardiac troponin I polyclonal antibodies were immobilised on the surface through linkage with the protein G layer, maintaining the correct orientation. (f)Cardiac troponin I can then be added to the developed biosensor.

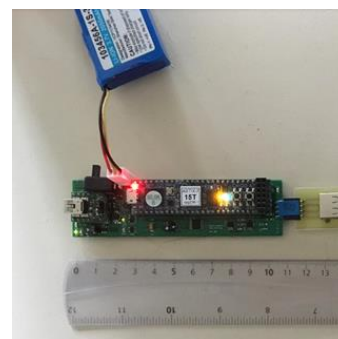

Fig. 3 Photo of the miniaturized EIS system

in contact with the electrode pads and a universal cable connects to the miniaturized EIS system (Fig 3).

C. Biosensor construction

The biosensor (Fig 2) was developed on the active area of the electrode array, a SAM layer was developed on top of the microbands, and the impedance measured at each stage, including for the unfunctionalized surface. The surface of the cleaned electrodes, a self-assembled monolayer was formed using the homobifunctional crosslinker DTTSP, by formation of a covalent bond between a reactive sulphur residue of DTSSP and the gold molecules. A 10µl aliquot of DTSSP (10mM) was deposited onto the active area and left to react for two hours at room temperature. The active area was then flood washed with 5ml of de-ionised water (Di-H₂O) followed by 5ml of phosphate buffered saline (PBS). In order to ensure the correct orientation of the antibodies, 10µl of protein G solution (50 µg/ml) was deposited and allowed to react with the amine-reactive groups of the SAM layer for one hour at room temperature. After which any sulpho-NHS groups left unreacted were blocked with 20mM ethanolamine for twenty-five minutes in room temperature. The active area

was flood washed with 5ml of Di-H₂O followed by 5ml of PBS.

Anti-human cTnI polyclonal antibodies was anchored to the biosensor surface by the interaction of their F_C domain with the bound protein G layer. The binding with protein G ensures that the F_{AB} domains of the antibodies are upright and free to react with the target antigen. Increasing the number of available sites for antigen binding results in better sensitivity. The sensor construction and measurements should also be more reproducible as the attachment is more controlled.

D. Developed cTnI immunosensor performance

After layer-by-layer construction the biosensor was kept at room temperature until the standards of cTnI were prepared. The biosensor was incubated with successive concentrations of troponin I (0.1pM, 10pM, 1nM, and 0.1μM) prepared in PBS, for twenty-five minutes at room temperature. The biosensor was washed after each incubation and impedance recorded as described previously.

To test the specificity of biosensor towards cTnI, a complete biosensor was incubated with human serum albumin at 5×10⁻³ng/ml for twenty-five minutes, followed by repeating the washing procedure. Zview software (Solartron Analytical, UK) was used to fit the EIS data to the Randles' equivalent circuit model. EIS parameters pertaining to solution resistance (R_S), charge-transfer/interfacial resistance (R_{CT}), and constant phase element (CPE) were obtained and analysed.

E. Miniaturized EIS device

A miniaturized EIS measurement system was developed as shown in Fig. 3. The system provides single-channel 4-electrode tetrapolar impedance measurement at 14 frequency points between 122 Hz and 1 MHz's. The impedance measurement uses single frequency sweep with sinusoidal current. Measurement results can be read in real-time via a USB connection to a PC, and can also be temporarily stored on the built-in RAM on the device and be exported later. The USB connection also provides battery charging.

The system diagram of the miniaturized device is illustrated in Fig. 4. The operation of the system is controlled by a Xilinx Artix-7 FPGA. The direct digital synthesis (DDS) logic in the FPGA generates single-tune sinusoidal waveform from a built-in look-up table (LUT). The frequency of the sinusoidal signal is decided by the step-size between two adjacent LUT readout. The output bitstream from the readout is converted into a sinusoidal signal by a 12-bit DAC, which drives a current driver to generate fully differential current output to the excitation electrodes at with a peak-to-peak amplitude of 50 μA and a dc level of 0 A. The differential voltage induced by this excitation current at the two recording electrodes is amplified in two stages with a variable gain between 1 and 10,000. The amplified voltage is then digitized by a 12-bit ADC, and the real and imaginary components in the measured impedance are calculated in the FPGA using coherent demodulation. The calculated impedance is first stored in a built-in RAM in the FPGA, then is exported to an external

processing device, such as a computer, when the frequency

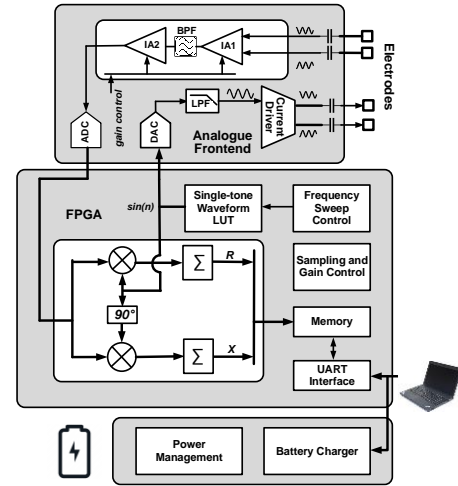
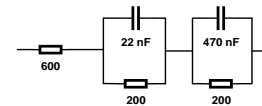

Fig. 4 System diagram of the miniaturized EIS system

sweep at all the 14 frequency points completes.

The FPGA operates at 64 MHz, providing a sampling rate of 32 MSps for each frequency point of impedance measurement. A full EIS measurement cycle takes 0.23 seconds over the 14 frequency points. The speed can be improved by using simultaneous multi-frequency measurement instead of single frequency sweep, such as the method proposed in [10]. However, the measurement frequency range in [10] is limited between 10 kHz and 1 MHz.

III. RESULTS



(a)

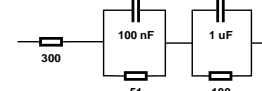

(b)

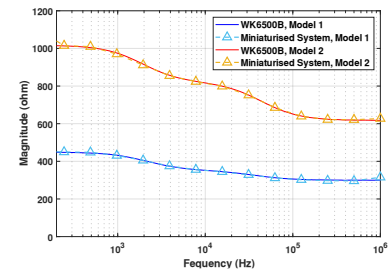

(c)

Fig. 5 RC model validate of the miniaturized EIT system: (a) RC model 1; (b) RC model 2; (c) measured impedance in comparison with the impedance measured with an impedance analyzer.

Two RC models are built to simulate bio-samples with different impedance, as shown in Fig. 5(a) and (b). The measured magnitudes of the impedance of the RC models are

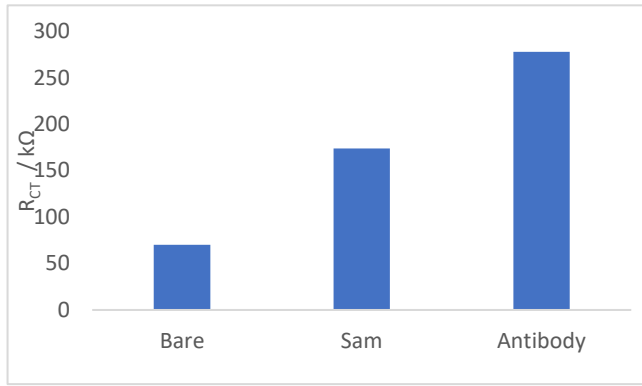

Fig. 6 Interfacial resistance obtained from fitting EIS data to the Randles circuit. The data represents one electrode array from bare electrodes to antibody deposition.

plotted in Fig. 5(c) alongside measured values from a benchtop impedance analyzer Wayne Kerr 6530B.

The magnitudes measured with the impedance analyzer are plotted in solid lines in red and blue, respectively, while the results from the miniaturized EIS system are plotted in dotted lines with triangle markers indicating the frequency points where measurement was taken. The results demonstrate good accuracy of the miniaturized EIS system. However, small measurement errors are observed at the low frequency (< 300 Hz) band, possibly due to the lower cut-off frequency of the bandpass filter for signal conditioning was set too high. The tested battery life of the device is > 12 hours before battery recharge is required. After confirming the successful construction of the biosensor, the construct was tested with solutions of PBS spiked with cardiac troponin I peptides at successive concentrations. Following the clinically relevant window of cTnI testing, concentrations from 10pM to 0.1μM were chosen, and thus an aliquot of each concentration was added to the surface of the biosensor for twenty-five minutes incubation followed by flood cleaning. After fitting the EIS data to the Randles circuit, the interfacial resistance of layer-by-layer construction was calculated to 70kΩ, 174kΩ, and 278kΩ, for bare gold, SAM, and antibody layers respectively. An increase of 150% and 60% respectively. Fig 6 shows the difference of obtained R_{CT} between the layers attached.

After confirming the successful construction of the biosensor, the construct was tested with solutions of PBS spiked with cardiac troponin I peptides at successive concentrations.

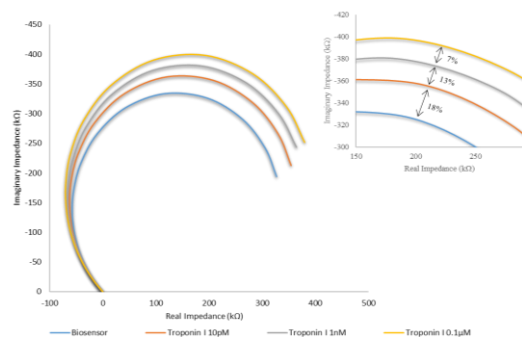

Fig. 7 Initial investigation of constructed biosensor with cTnI concentrations between 10pM and 0.1μM.

Following the clinically relevant window of cTnI testing, concentrations from 10pM to 0.1μM were chosen, and thus an aliquot of each concentration was added to the surface of the biosensor for twenty-five minutes incubation followed by flood cleaning. Fig. 7. shows the resulting fits from the EIS spectra. The interfacial resistance increased 8% after adding 10pM cardiac troponin I increased by 13% and 18% for 1nM and 0.1μM respectively. Despite the small magnitude of the resistance increase, it occurred linearly which indicates the successful detection of cardiac troponin I in the clinical range with the constructed biosensor. The measurements were repeated with 10 sensors with approximately 0.5% variance in the results.

IV. CONCLUSION

The current work shown the constructed of a cardiac troponin I immunosensor biosensor device. This work is a good indication of the ability of the EIS biosensor with non-complex construction for function with good stability and sensitivity. In future works, the miniaturized EIS measurement system can be further integrated into a system-on-chip device, where ultra-low-power impedance calculation methods, such as the time-stamp technique, can be employed. The sensor has the potential to achieve very low sensitivity (LOD = 1.37 pg/ml) compared to three electrode EIS sensors.

REFERENCES

- [1] S. O. Catarino, V. Hugo Pereira, N. Sousa and G. Minas, "Challenges and Perspectives on Biosensors for Highly Sensitive Quantification of Salivary Troponins: A Review," in *IEEE Sensors Journal*, vol. 21, no. 13, pp. 13976-13984, 1 July 2021, doi: 10.1109/JSEN.2020.3004239.
- [2] Negahdary M, Behjati-Ardakani M, Heli H, Sattarahmady N. A Cardiac Troponin T Biosensor Based on Aptamer Self-assembling on Gold. *Int J Mol Cell Med.* 2019;8(4):271-283. doi:10.22088/IJCM.BUMS.8.4.271.
- [3] Çimen D, Bereli N, Günaydın S, Denizli A. Detection of cardiac troponin-I by optic biosensors with immobilized anti-cardiac troponin-I monoclonal antibody. *Talanta.* 2020 Nov 1;219:121259. doi: 10.1016/j.talanta.2020.121259. Epub 2020 Jun 15. PMID: 32887150.
- [4] Akter, R., Jeong, B., Lee, Y. M., Choi, J. S. & Rahman, M. A. Femtomolar detection of cardiac troponin I using a novel label-free and reagent-free dendrimer enhanced impedimetric immunosensor. *Biosens. Bioelectron.* **91**, 637–643 (2017).
- [5] Qiao, X. *et al.* Novel electrochemical sensing platform for ultrasensitive detection of cardiac troponin I based on aptamer-MoS2 nanoconjugates. *Biosens. Bioelectron.* **113**, 142–147 (2018).
- [6] Sandil, D. *et al.* Biofunctionalized nanostructured tungsten trioxide based sensor for cardiac biomarker detection. *Mater. Lett.* **186**, 202–205 (2017).
- [7] Akter, R., Jeong, B., Lee, Y. M., Choi, J. S. & Rahman, M. A. Femtomolar detection of cardiac troponin I using a novel label-free and reagent-free dendrimer enhanced impedimetric immunosensor. *Biosens. Bioelectron.* **91**, 637–643 (2017).
- [8] Shanmugam, N. R., Muthukumar, S. & Prasad, S. Ultrasensitive and low-volume point-of-care diagnostics on flexible strips-a study with cardiac troponin biomarkers. *Sci. Rep.* **6**, 1–10 (2016).
- [9] Wang SX, Acha D, Shah AJ, Hills F, Roitt I, Demosthenous A, Bayford RH. Detection of the tau protein in human serum by a sensitive four-electrode electrochemical biosensor. *Biosens Bioelectron.* 2017 Jun 15;92:482-488. doi: 10.1016/j.bios.2016.10.077. Epub 2016 Oct 28. PMID: 27829556.
- [10] L. Regnacq, Y. Wu, N. Neshatvar, D. Jiang and A. Demosthenous, "A Goertzel Filter-Based System for Fast Simultaneous Multi-Frequency EIS," in *IEEE Transactions on Circuits and Systems II: Express Briefs*, vol. 68, no. 9, pp. 3133-3137, Sept. 2021.