



**Middlesex
University
London**

Middlesex University Research Repository:

an open access repository of
Middlesex University research

<http://eprints.mdx.ac.uk>

Rathbone, John, 2002.

The process of conducting herbal medicine research through the clinical trials exemption scheme.

Available from Middlesex University's Research Repository.

Copyright:

Middlesex University Research Repository makes the University's research available electronically.

Copyright and moral rights to this thesis/research project are retained by the author and/or other copyright owners. The work is supplied on the understanding that any use for commercial gain is strictly forbidden. A copy may be downloaded for personal, non-commercial, research or study without prior permission and without charge. Any use of the thesis/research project for private study or research must be properly acknowledged with reference to the work's full bibliographic details.

This thesis/research project may not be reproduced in any format or medium, or extensive quotations taken from it, or its content changed in any way, without first obtaining permission in writing from the copyright holder(s).

If you believe that any material held in the repository infringes copyright law, please contact the Repository Team at Middlesex University via the following email address:
eprints@mdx.ac.uk

The item will be removed from the repository while any claim is being investigated.

**THE PROCESS OF CONDUCTING HERBAL MEDICINE
RESEARCH THROUGH THE CLINICAL TRIALS
EXEMPTION SCHEME**

By

JOHN RATHBONE

**Submitted in partial fulfilment of the requirement
for the degree of Master of Philosophy**

School of Health and Social Sciences

Middlesex University

October 2002

ABSTRACT

The primary aims of this study were to develop research methodology in order to investigate the efficacy of herbal medicine in alleviating menopausal symptoms, and to prepare an application for submission to the Medicines Control Agency (MCA) to gain approval to run a randomised, double blind, placebo controlled clinical trial. A research protocol was developed which outlined the key stages of the study for subsequent review and approval by an ethics committee. An operations manual was developed to guide and instruct clinicians on how the study should be implemented. This required the development of case history notes, screening procedures, timetable flow charts and adverse event reporting cards specifically for this study. An original herbal formula was developed for this study based on a literature review of medicinal plants. A 54-page exemption from licences MLA-164 application was completed, which set out in detail the design of the study. The pharmacological properties of the medicinal plants were reviewed from the literature and listed in detail to satisfy the MCA's requirements for scientific evidence of efficacy and safety. Heavy metal analysis was performed for quality control purposes to examine the feasibility of being able to meet specification limits for metal contamination in medicinal herbs. This was conducted using Inductively Coupled Plasma-Atomic Emission Spectroscopy on a total of 16 herb samples, eight samples of *Hypericum perforatum* L. and eight samples of *Salvia officinalis* L. from cultivation sites in the UK and Europe. Mean metal ion concentrations of lead, cadmium, mercury, copper, zinc, nickel and chromium were found to be below statutory limits and guidelines, and would therefore satisfy the requirements of an MLA-164 application for metal contamination. High Performance Liquid Chromatography was performed using UV detector and Diode-Array detector systems to determine the suitability of each method to provide a 'fingerprint' analysis of the medicinal herbs for the purposes of establishing plant authenticity. The diode-array analysis was superior to simple UV detector methodology because it was able to provide greater accuracy to determine the chemical group for some unknown constituents. However, neither system provided adequate phytochemical profiles to authenticate the medicinal plants. The research study provided a novel insight into the processes required for the design and implementation of a herbal medicine clinical trial, and has expanded the current knowledge of the requirements for completing a clinical trials application (MLA-164) to the MCA.

ACKNOWLEDGEMENTS

The author wishes to thank the following persons for their guidance, advice and contribution to the research project:

Dr Celia Bell-Academic Supervisor, Director of Studies, School of Health, Biological and Environmental Sciences, Middlesex University.

Andrew Chevallier- Lead Academic, School of Health, Biological and Environmental Sciences, Middlesex University.

Professor Mike Revitt- Director of Research and Postgraduate Studies, School of Health, Biological and Environmental Sciences, Middlesex University.

Dr Kofi Busia- Senior lecturer in Pharmacognosy and Herbal Pharmacology, School of Health, Biological and Environmental Sciences, Middlesex University.

Dr Ellis Snitcher- Principal lecturer in Clinical Sciences, School of Health, Biological and Environmental Sciences, Middlesex University.

Dr Linda Bell- Principal lecturer in Research Methods, School of Social Science, Middlesex University.

Mekibib Dawit- Research Student, Department of Environmental Science, School of Health, Biological and Environmental Sciences, Middlesex University.

Alan Lagrue- Laboratory Technician, Department of Environmental Science, School of Health, Biological and Environmental Sciences, Middlesex University.

Renee Grayer- Department of Pharmacognosy, The Royal Botanical Gardens, Kew.

Dr Rosemary Cole- The National Herb Centre, Oxford.

Dr Ivan Huasse- National Poisons Unit, Guy's Hospital.

Dr Pauline Hili, Romy Fraser and Susan Curtis- Neal's Yard Remedies.

Dr Paul Naylor- Teaching Company Scheme.

In addition, the Teaching Company Scheme (TCS) and Neal's Yard Remedies financially supported this work.

Contents

	Page
Abstract	i
Acknowledgements	ii-iii
Contents	iv-vi
List of Tables	vii
List of Figures	viii
List of Abbreviations	ix
Chapter 1 Introduction	
1.1 Background	1-7
1.2 Aims and Objectives of the Research	7-8
1.3 Overview	8-12
Chapter 2 The Physiology of the Menopause	
2.1 Background	13
2.2 Definition of the Menopause	13
2.3 The Perimenopause	13-14
2.4 The Menopause	14-16
2.5 Summary	16
Chapter 3 Developing a generic herbal formula	
3.1 Introduction	17
3.2 Developing a Herbal Formula	18-21
3.3 Placebo	21-22
3.4 Quality control	22-23
3.5 Harvesting and storage	23
3.6 Authentication and Documentation	24
3.7 Stability Testing	25-26
3.8 Stability Program and Test Conditions	26-28
3.9 Summary	28

Chapter 4	Research Study Design	
4.1	Introduction	29-30
4.2	Research Protocol	30-31
4.3	Background	31
4.4	Methodology	31-32
4.5	Patient Consent	32
4.6	Operations Manual	32-33
4.7	Practitioner Instructions	33
4.8	Case History Notes	33-34
4.9	Patient Recruitment and Appointments	34-35
4.10	Questionnaire Development	35-40
4.11	Questionnaires chosen for the clinical trial	41-42
4.12	Data Analysis	42
4.13	Statistical Power of the Study	42-45
4.14	Randomisation	45-46
4.15	Summary	47-48
Chapter 5	Clinical Trials Application To The Medicines Control Agency	
5.1	Introduction	49
5.2	The Medicines Control Agency's Remit	50
5.3	Clinical Trials Exemption Scheme	50-51
5.4	Clinical Trials Application Forms	51-52
5.5	MCA Requirements	52-53
5.6	Completion of the MLA-164 Application	53-56
5.7	Summary	56-57
Chapter 6	Heavy Metal Analysis	
6.1	Introduction	58
6.2	Materials	59
6.3	Methods	59-60
6.4	Results- Heavy Metal Concentrations	61-62
6.5	Discussion	63-65

Chapter 7	HPLC Analysis	
7.1	Introduction	66-67
7.2	High Performance Liquid Chromatography Spectra	67-68
7.3	Plant Extraction	68-70
7.4	Materials	71
7.5	Method - Plant Extraction	71
7.5.1	High Performance Liquid Chromatography	71-72
7.6	Results	73-81
7.7	Discussion	82-83
Chapter 8	Discussion and Conclusions	
8.1	The Menopause and Hormone Replacement Therapy	84
8.2	Research Funding for Herbal Medicine	84-85
8.3	Research Methodology for Herbal Medicine	85
8.4	The limitation of the MLA-164 application process	85-87
8.5	Bibliographic Information to Support an Application	87-88
8.6	Quality Control Procedures	88
8.7	The Production of Medicinal Herbs	89
8.8	Experimental Results	89-90
8.9	Conclusions	90-92
References		93-102
Appendix I	Research Protocol Submitted to the University Ethics Committee	103-117
Appendix II	Practitioners Operations Manual	118-138
Appendix III	Poster	139
Appendix IV	Leaflet	140
Appendix V	Timetable flow chart	141
Appendix VI	Women's Health Questionnaire	142-144
Appendix VII	MYMOP	145-146
Appendix VIII	MLA-164	147-200

List of Tables

		Page
Table 1	Herbs that are cited in herbal pharmacopoeias for the alleviation of menopausal symptoms	19
Table 2	The Herbal Formulae	21
Table 3	ICH Test Conditions for Stability Studies	27
Table 4	Typical costs of Newspaper advertising	35
Table 5	Typical dimensions of quality of life instruments	36
Table 6	Factors influencing the selection of instruments	37
Table 7	Benefits and shortcomings of generic as compared with Condition Specific questionnaires	38
Table 8	Treatment effect differences for generic and menopause specific QoL questionnaires	39
Table 9	Subscales used for the factorially derived questionnaires	40
Table 10	Values of $f(\alpha, \beta)$ to be used in formula for required number of patients	45
Table 11	Random numbers list	46
Table 12	The probability of imbalances occurring in two treatment groups for various trial sizes	46
Table 13	Mean (SD ± 0.03) metal ion concentrations (ppm) in <i>H. perforatum</i> from different locations in the UK and Europe	61
Table 14	Mean (SD ± 0.03) metal ion concentrations (ppm) in <i>S officinalis</i> from different locations in the UK and Europe	62
Table 15	Existing Solvent Extraction Methods	70

List of Figures

		Page
Figure 1	Plasma hormone changes in pre-and-post menopausal women	15
Figure 2	Peak shape of genistein	68
Figure 3	Peak shape of kaempferol	68
Figure 4	Peak shape of apigenin	68
Figure 5	Chromatogram of <i>Hypericum perforatum</i> at 260nm with UV detector	74
Figure 6	Chromatogram of <i>Hypericum perforatum</i> at 260nm with diode array	74
Figure 7	Chromatogram of <i>Cimicifuga racemosa</i> at 260nm with UV detector	76
Figure 8	Chromatogram of <i>Cimicifuga racemosa</i> at 260nm with diode-array detector	76
Figure 9	Chromatogram of <i>Dioscorea villosa</i> at 260nm with UV detector	77
Figure 10	Chromatogram of <i>Dioscorea villosa</i> with diode-array detector	78
Figure 11	Chromatogram of <i>Salvia officinalis</i> at 260nm with UV detector	79
Figure 12	Chromatogram of <i>Salvia officinalis</i> at 260nm with diode-array Detector	79
Figure 13	Chromatogram of <i>Glycyrrhiza glabra</i> at 260nm with UV detector	80
Figure 14	Chromatogram of <i>Glycyrrhiza glabra</i> at 260nm with diode-array Detector	81

List of Abbreviations

BKI-	Blatt-Kupperman Index
CAM-	Complementary and Alternative Medicine
CTX-	Clinical Trials Exemption Scheme
DDX-	Doctors and Dentists Exemption Scheme
FSH-	Follicular Stimulating Hormone
GC-	Gas Chromatography
GCMS-	Gas Chromatography Mass Spectroscopy
GCS-	Greene Climacteric Scale
HPLC-	High Performance Liquid Chromatography
ICH-	International Conference on Harmonisation
LH-	Lutenising Hormone
MCA-	Medicines Control Agency
MENQOL-	Menopause Specific Quality of Life Questionnaire
MLA 164 –	Clinical Trials Exemption form
MSL-	Menopause Symptom List
MYMOP-	Measure Yourself Medical Outcome Profile
NHP-	Nottingham Health Profile
NIMH-	National Institute of Medical Herbalists
NMR-	Nuclear Magnetic Resonance
PGWBI-	Psychological General Well-being Index
QoL-	Quality of Life
SPSS-	Statistical Package for Social Science
TLC-	Thin Layer Chromatography
UKAS-	United Kingdom Accreditation Services
VAS-	Visual Analogue Scale
WHQ-	Women's Health Questionnaire

CHAPTER 1

INTRODUCTION

1.1 Background

Menopause is the permanent cessation of menstruation in women, as a result of declining oestrogen hormones. This normal transition usually occurs at the mean age of 51 and can be accompanied by unpleasant vasomotor symptoms such as hot flushes and night sweats. Declining oestrogen levels are also associated with increased risk of osteoporosis (Gambacciani *et al* 1995), cardiovascular disease (De Aloysio *et al*, 1999), urogenital atrophy (Samsoie, 1998), cognitive decline (Solerte *et al*, 1998) and Alzheimer's disease (Inestrosa *et al*, 1998).

By the year 2000, an estimated 31.2 million women will have undergone the menopausal transition (Wolinsky, 1994), a number that is expected to increase to 1.3 billion by the year 2030 (WHO, 1996). These increases will inevitably lead more women to seek medical attention for the immediate symptoms of the menopause. This will ultimately require more resources being made available to meet the increasing costs of medical care in the ageing population.

Medical expenses in England and Wales, associated with osteoporosis, have been estimated at £940 million every year (Dolan, 1998) and menopausal osteoporotic related fractures can result in both morbidity and mortality. Fractures are not the immediate problems facing menopausal women, since most of them occur later in life, usually around 70-80 years. However, skeletal atrophy increases around the time of the menopause by 2.5% per year (Slemenda *et al*, 1987) and continues, to a lesser

degree, into old age. Strategies aimed at slowing the rate of bone loss could reduce NHS expenditure and alleviate suffering later in life.

The main treatment for menopausal complaints is Hormone Replacement Therapy (HRT), which is used to relieve symptoms such as hot flushes and night sweats. HRT helps to prevent atrophic vaginitis, osteoporosis and atherosclerosis (Smith, 1995), and consists of synthetic oestrogens that mimic the female hormones, or so-called natural oestrogens made from the urine of pregnant mares (premarin). Both are different in chemical structure from natural hormones (Rogers, 1995). Side effects from HRT include nausea, vomiting, fluid retention, headaches, depression and uterine cancer (BNF, 2001).

In the USA, it has been estimated that between 10%-35% of menopausal women are using HRT (Utian and Schiff, 1994), while in the UK, as few as 7-10% of women use HRT (Hunter, 1994). This low use of HRT has been attributed to women being unwilling to use this treatment for a number of reasons including concerns regarding the risks of breast cancer and other hormone dependent cancers, side-effects of the treatment and medicalisation of a normal physiological process (Siddle, 1993). Furthermore, oestrogen therapy is not an option for some women because of side-effects or contraindications (Barlow, 1992). A safe and efficacious herbal alternative to HRT would therefore be welcome. The reluctance of women to use HRT, is indicated by the fact that many women who begin HRT stop within a few months (Kaufert, 1986), with the average duration of use being only 9 months (Sheehy, 1992).

It is questionable whether, historically, much emphasis was focused on developing treatment strategies for menopausal symptoms, given that the low life expectancy would have limited such prevalence. Life expectancy for women in the United States had only reached 49 by the 1900's (Speroff, 1999). Yet today, women have a life expectancy of 79.7 years and can expect to spend one-third of their lives postmenopausal, a significant number suffering from initial vasomotor problems such as hot flushes and the later complications of osteoporosis. Historical documentation of the use of herbal medicine to alleviate menopausal symptoms is scarce. In Traditional Chinese Medicine the therapeutic treatment of the menopause does not exist, as it is not regarded as a physiologic modality requiring treatment. However, treatment strategies were developed in China during the Song Dynasty (1119 A.D) for a pattern of disharmony similar to menopausal symptoms. In the European herbal tradition, *Salvia officinalis* (sage), was prescribed in the 1800's for excessive sweating (Culbreth, 1927) while in North America, native Indians have used *Cimicifuga racemosa* (Black cohosh) for menstrual irregularities. The importance of *C. racemosa* as a medicinal plant was recognised in the first works on American herbs, which date back to 1801. *C. racemosa* was an official drug of the United States Pharmacopoeia from 1820 to 1926 and was used as an aid for child birth (Foster, 2000). Whilst *S. officinalis* and *C. racemosa* have had a relatively long traditional use in menopausal complaints, other herbs such as *Eleutherococcus senticosus* (Siberian ginseng) appear to have been incorporated, more recently, into the therapeutic strategy of practitioners (Fulder, 1988).

It has been suggested that herbal medicine may offer an alternative to HRT due to plant constituents that have been found to mimic or interact with oestrogenic receptor

sites in animals. More than 20 compounds have been identified in at least 300 plants from 16 different plant families. These compounds, referred to as phytoestrogens, are weaker than natural oestrogens and are found in herbs, grains and vegetables (Knight *et al*, 1996; Thompson *et al*, 1991).

Certain phytoestrogens have been investigated as having potential in the treatment of menopausal symptoms and osteoporosis and may also have cancer preventative qualities. Laboratory experiments and comparisons of Asian and Western human populations suggest that diets rich in phytoestrogens may play a role in these types of health problems. One study found that Asian populations who eat substantially greater amounts of soy products (which contain phytoestrogens such as genistein and daidzein), have lower rates of hormone dependent cancers such as breast and endometrial cancers and a lower incidence of menopausal symptoms and osteoporosis than Westerners (Barrett, 1996). Furthermore, Somekawa *et al* (2001) found that Japanese menopausal women who consumed a diet high in soy based products, containing isoflavones, had higher bone mass density.

In patient trials, *Cimicifuga racemosa*, soy based products and genistein which is a commonly found phytoestrogen, have been shown to be effective in the treatment of hot flushes (Brzezinski and Debi, 1999). Isoflavones and other phytoestrogens found in soybeans, as well as flaxseed, have beneficial effects on vasomotor symptoms and bone health (Anderson, 1999).

These studies along with the majority of phytochemical medical research reflect the current emphasis on research into single herbs or their constituents and are not representative of the usual practice of herbal medicine.

In herbal practice, treatment usually takes the form of a complex herbal formula aimed at treating the whole patient and stressing the importance of individualised treatment. Herbs will often be added to a formula in order to attenuate the action of other herbs for example fennel is commonly used to alleviate colicky griping pain that can occur with strong herbal purgatives (Bone and Mills, 2000). Furthermore, synergism is a well known concept in phytotherapy and evidence is accumulating to suggest that this does occur in extracts of herbs and in mixtures (Williamson, 2001). Designing appropriate clinical trials in which investigations take into account the individualised nature of the treatments as well as satisfying the demands for scientific rigour is important to the progress of research in this area.

The need for an improved evidence base for the practice of herbal medicine was recognised in a Lords Select Committee report on Complementary and Alternative Medicine (CAM) published in November 2000. In this report the growth in the use of complementary medicine was acknowledged, estimating that approximately one third of the UK population are now using complementary medicine (Zollman and Vickers, 1999). Complementary medicine in the UK remains largely outside of mainstream provision. One reason identified by the select committee report as a hindrance to the integration of complementary medicine into the NHS is the lack of research studies.

The report states:

“There has been increased public interest in the use of complementary and alternative medicine in recent years. CAM is a thriving feature of the private health care sector, and may owe some of its commercial success to the fact that it currently enjoys relatively light regulation. CAM can also play a part in treating NHS patients, but if it aspires to be an equal player with other forms of NHS treatment, it must meet the same standards required of them and it must be clear and realistic about the contributions it can make. In our opinion any therapy that makes specific claims for being able to treat specific conditions should have evidence of being able to do this above and beyond the placebo effect. This is especially true for therapies, which aim to be available on the NHS (The National Institute of Medical Herbalists [NIMH], the main governing body representing herbal medicine practitioners in the UK, aspires to make herbal medicine available either within the NHS or through referrals). We recommend that if a therapy does gain a critical mass of evidence to support its efficacy, then the NHS and the medical profession should ensure that the public have access to it and its potential benefits” (House of Lords, 2000).

The recognition of the important contribution that complementary medicine has made in private health care and the potential that it has to offer to the NHS, once greater evidence of efficacy is established has given an impetus to research in this area. This need is reflected by patients who seek out alternatives to prescription medication because of concerns for potential side effects or absolute contraindication, or simply because there is no effective pharmaceutical therapy available.

As well as the need to develop appropriate methodologies for investigating the efficacy of herbal medicines there is also a need for this area to succeed in attracting research funding. Currently, only 0.08% of NHS funding goes to complementary

medicine, (Ernst *et al*, 2001). Also, the Medical Research Council provided no research expenditure for complementary therapies between 1998 and 1999 and British medical research charities spent only 0.05% of their total research budget during 1999 in this area (Rees and Weil, 2001). The reason why there is little research funding made available to complementary medicine is unclear. Possible explanations may relate to research applications not being sufficiently rigorous, lack of expertise in complementary medicine, or biased attitudes within the orthodox medical profession. However, there is sufficient published research demonstrating efficacy of herbal medicine (Sheehan *et al* 1992; Woelk, 2000; Stoll, 1987) to justify additional funding or a reassessment in budget allocations.

Summary

There is a need to investigate alternatives to HRT and there is some evidence to suggest that treatment based on herbal practice may be efficacious. There is also a recognised need to develop appropriate methodologies for research in this area, which is sufficiently scientifically rigorous to attract research funding, and reflects the actual practice of herbal medicine.

1.2 Aims and Objectives of the Research

The aim of this work was to develop a research study to investigate the efficacy of herbal medicine to alleviate menopausal symptoms, including the use of a poly-herbal formula to reflect the traditional practice of herbal medicine, whilst retaining the rigour of a randomised, double-blind placebo controlled trial. The project aimed to develop an understanding of the research process pertinent to herbal medicine, thus

potentially highlighting areas of difficulty encountered with (CAM) research. This was achieved through the following objectives:

- 1) Develop a generic herbal formula for menopausal complaints, i.e. aiming to treat multiple symptoms.
- 2) Ensuring adequate quality control procedures was used in the process of producing the formula to satisfy MCA requirements.
- 3) Producing a clinical trial protocol for an ethics committee to ensure the research study met the requirements of the Helsinki agreement.
- 4) Producing an operations manual to enable clinicians to implement the study.
- 5) Designing advertising media to promote the clinical trial.
- 6) Completing initial quality control procedures for heavy metal analysis and HPLC fingerprint analysis.
- 7) Completing a MLA-164 (CTX) application for submission to the Medicines Control Agency.

1.3 Overview

The first objective, which was to develop a novel generic herbal formula for menopausal symptoms, was achieved by reviewing the current literature on the endocrinology of the menopause to determine the impact hormonal variations have on menopausal symptoms. The hormonal changes that occur during the menopausal transition show wide variations in women, and are not related to the severity of hot flushes. These variations mean that measurement of hormone levels is not a reliable

method to determine the menopausal status of women. Furthermore, the failure to establish a definite link between hormonal levels and symptom severity is pertinent to this research, because the rationale of the treatment should not have to be based solely on the plants providing a hormonal action, given the lack of evidence correlating symptom severity with hormone levels. This fact is important in fulfilling the requirements of the MLA-164 document, given the need to provide a therapeutic rationale for the herbal formula. A further literature search was then conducted to determine which herbal medicines might be efficacious for the alleviation of menopausal symptoms, based on clinical studies and empirical evidence. The information derived from the literature provided the basis for the development of the herbal formula.

The second objective, which was to ensure adequate quality control procedures were devised for the production of the herbal formula, was achieved by investigating the different quality control processes available to ensure good manufacturing procedures (GMP) and safety standards would be applied in the production of the herbal drug. This required scrutinising quality control guidelines and good manufacturing procedures from sources such as, The Soil Association, International Conference on Harmonisation, government publications, and various research papers that have investigated quality control methods specific to herbal medicines. The relevant information was then extracted and collated into a novel and unique set of safety procedures specifically for this herbal medicine study as a means of demonstrating to the MCA that appropriate quality control methods would be implemented.

The third objective, which was to produce and submit a clinical trials protocol to the university's ethics committee, was achieved based on the development of a novel research design for a double-blind placebo controlled clinical trial with menopausal women. The protocol set out how participants would be selected, the number of participants to be used in the study, the type of measurement tools used and methods of obtaining patient consent in accordance with the principles set out in the Helsinki agreement. These procedures set out in the protocol were essential to demonstrate to the MCA that the study would be both feasible and ethical.

The fourth objective, which was to develop an operations manual for the study, was achieved by producing a detailed set of unique instructions to enable the clinicians to administer the clinical trial uniformly. Patient case history notes and screening questions were specifically developed for the study to assess the participant's health status and eligibility. This was essential to avoid methodological errors and to demonstrate to the MCA that appropriate measures would be undertaken to ensure patients' welfare was addressed. This manual has provided a novel and valuable example of the procedures which need to be followed in a study to ensure it is methodologically robust, uniformly administered and meets the ethical requirements of the Helsinki agreement.

The fifth objective, which was to design advertising media for the clinical trial, was achieved by the production of a novel poster and leaflet for the study. The poster was designed to include the essential aspects of the trial, whilst being sufficiently bold to attract the attention of our target audience. The leaflet was produced to provide additional information about the trial for the potential participants. Also, other

methods of recruiting patients were investigated which involved examining the typical cost of advertising, which was found to be relatively expensive.

The sixth objective, which was to conduct initial quality control procedures on the medicinal plants, was achieved by performing an analysis of the levels of heavy metals present in *Hypericum perforatum* and *Salvia officinalis*, using Inductively Coupled Plasma-Atomic Emission Spectroscopy (ICP-AES). This information was particularly valuable because there is a paucity of data available on metal contaminant levels in medicinal plants. This resulted in new and novel information being made available on the typical levels of heavy metal contaminants found in *Hypericum perforatum* and *Salvia officinalis* from UK and European sources, and thus provided a valuable reference to determine the potential of being able to meet the MCA's safety specifications. High Performance Liquid Chromatography (HPLC) was also conducted to perform a 'fingerprint' analysis of the medicinal plants using UV and diode-array detector systems to determine whether either system would be an appropriate tool to aid plant authenticity. The results of the HPLC analysis provided a new understanding of the benefits and limitations that liquid chromatography offers for establishing plant authenticity in relation to the MCA specifications.

The seventh objective, which was to complete an MLA-164 application ready for submission to the MCA, was achieved by the completion of a 54-page document specifically for the study. The completed MLA-164 document set out how the clinical trial was to operate, the quality control measures to be used, and provided a unique and extensive synthesis of the scientific supporting evidence on the herbs, to enable the MCA to determine the safety and validity of the proposed study.

The process of completing an MLA-164 application for a herbal medicine clinical trial was novel, and elucidated an area of knowledge that has, until now, been inadequately reported. The MCA normally receives applications from pharmaceutical drug companies who are proposing to test a drug consisting of a single compound. In contrast, the active constituents of medicinal herbs are often unknown and many of the phytochemicals within plants have not been identified. Fulfilling the MLA-164 pharmaceutical requirements for the herbal formula that contained numerous compounds was challenging especially because of the limited data available on the pharmacology and pharmacognosy of medicinal plants.

In this thesis, the author has attempted to elucidate the processes necessary for designing a herbal medicine clinical trial for submission to the MCA. This is an area that is both poorly researched and understood. The completed MLA-164 document, the protocol, operations manual, advertising media, and patient time-tables were specifically designed for this project and provide a novel insight into the processes necessary for the design of a herbal medicine clinical trial with menopausal women. These documents are placed in the appendices for clarity and easy reference.

CHAPTER 2

THE PHYSIOLOGY OF THE MENOPAUSE

2.1 Background

A review of the physiological processes that occur during the menopause and pre-and post menopause was conducted. This was performed to explain the hormonal and physiological changes that lead to menopausal symptoms and ultimately infertility.

2.2 Definition of the Menopause

The World Health Organisation's definition of the menopause is 'the time of permanent cessation of menstruation due to loss of ovarian follicular activity' and is usually established, retrospectively, after 12 months of amenorrhoea (Richardson, 1993). From the standpoint of the ovary, the menopause is not a sudden event but is a cumulative process from foetal life, since the maximum number of follicles, estimated between 2×10^6 and 6×10^6 , is reached whilst *in utero*. During further foetal development follicles begin to disappear as a result of atresia (cell death) which continues until just before menopause is reached (Richardson, 1990).

2.3 The Perimenopause

The perimenopause is the phase from the onset of menopausal symptoms to one-year after the final menstrual period, with a mean onset of 45.5-47.5 years and an average duration of 5 years, as established in longitudinal studies, (McKinlay *et al*, 1992). Traditional concepts about the endocrine changes around the perimenopause include gradually declining oestrogen levels and rising gonadotropins (Burger and Teede, 1999). However, wide variations in hormonal profiles of luteinising hormone (LH),

follicular stimulating hormone (FSH) and oestradiol can occur in serum during the perimenopause (Gow *et al*, 1994), although evidence suggests that oestrogen and FSH levels rise during the perimenopause, with raised FSH being the most consistent feature. LH may rise in some women before menopause although LH remains in the normal range in most women despite the rise in FSH (Metcalf and Livesey, 1985). Studies of perimenopausal women have shown the variations in FSH, inhibin, and oestrogen levels to be transient, and therefore, unreliable in diagnosing approaching menopause or in predicting the stage of menopausal transition for any woman (Burger, 1994).

2.4 The Menopause

The precise endocrinological changes during the menopause are still being clarified, although it is known there is an exponential decline in oocyte numbers as menopause approaches. The pattern of gonadotrophin, oestradiol and progesterone production fluctuates, especially in women whose last cycles may be irregular in length (Sherman *et al*, 1976). This shows that mean data may not necessarily apply to any one individual. The first sign of approaching menopause is a decline in fertility and the first endocrine change is a fall in inhibin production by the ovary. The role that inhibin plays is significant, with reduced negative feedback on the pituitary resulting in increased FSH production. The glycoprotein inhibin blocks the production of FSH by the anterior pituitary and hence, with the loss of restraint, plasma FSH concentration begins to rise above the pre-menopausal upper limit of 5 IU/l (Campbell and Monga, 2000). At the menopause, LH levels rise and plateau after about 12 months of amenorrhoea (Longcope *et al*, 1986). Much of this rise is caused by the decline in ovarian oestrogen secretion and the resultant loss of the negative feedback.

During the menopause, there is a decline in the ovarian secretions of oestrogens, and only about 10% of menopausal women are able to secrete significant quantities of ovarian oestradiol (Longscope *et al*, 1980). Oestrone levels decrease by 50 to 80% at the menopause, and due to the decline in oestradiol, oestrone becomes the prominent circulating oestrogen (Gow *et al*, 1994). For most menopausal women, the major source of circulating oestradiol is from the peripheral aromatisation of androgens (Siiteri and MacDonald, 1973). Figure 1 shows the typical hormonal changes that occur during peri-and post menopause.

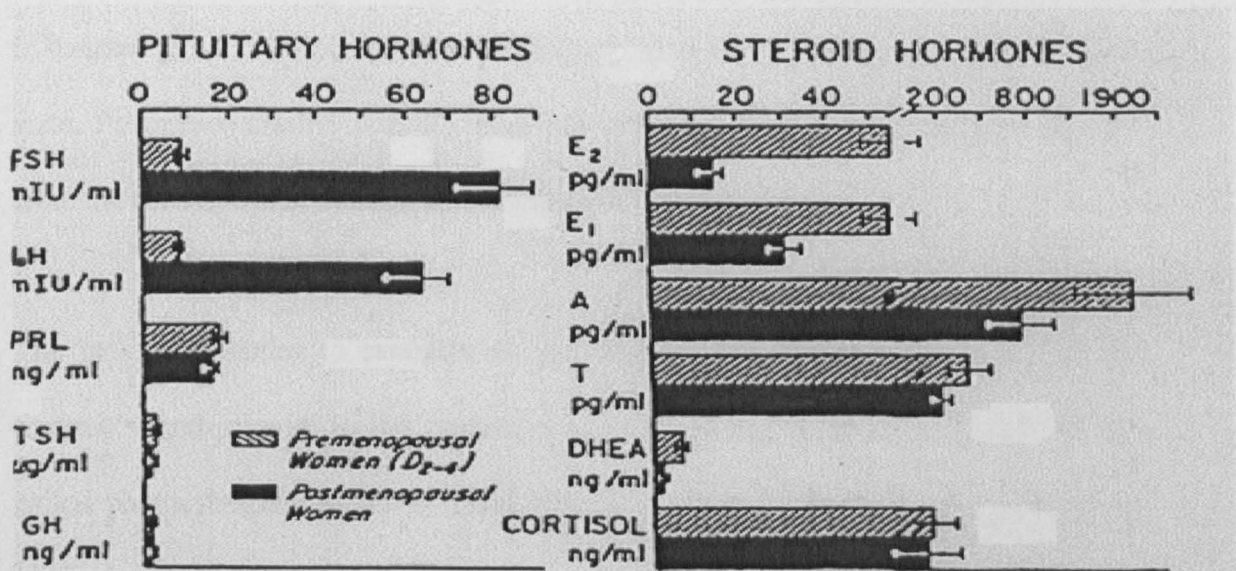

Fig. 1 Blood plasma hormone changes in pre-and-post menopausal women (Yen, 1977).

FSH =Follicular Stimulating Hormone

LH =Lutinising Hormone

E1 =estradiol

E2 =estrone

A =androstenedione

T =testosterone

DHEA =dehydroepiandrosterone

GH =growth hormone

PRL =prolactin

TSH =thyroid stimulating hormone.

2.5 Summary

There is a decline in fertility and alteration in menstrual cycle prior to the menopause. A wide variety of hormonal patterns of LH, FSH and oestradiol can occur in perimenopausal women, although raised FSH appears to be a prominent feature, which is accompanied by a decline in oocyte numbers and inhibin levels. Measurement of serum hormones to determine menopausal status is unreliable due to wide hormonal fluctuations and there are no objective means of determining improvements in menopausal symptoms, since hormonal levels are unreliable predictors of either menopausal status or symptom severity (WHO, 1996). The decline in ovarian function that culminates in the menopause gives rise to a hormone deficient state. Postmenopausally, oestrone becomes the major circulating oestrogen derived from the conversion of adrenal androstenedione in adipose tissue.

The lack of evidence to establish an association between hormone levels and the frequency and severity of hot flushes is pertinent to this study. It is known that so called phytoestrogens found in plants have a weak endocrine effect compared with HRT or endogenous hormones. However, since hormone levels are not determinants for the severity of hot flushes, the relative lack of an endocrine effect should not be a determinant of the efficacy of herbal medicines. In fact the therapeutic activity may be due to some other, as yet unknown, action of medicinal plants.

CHAPTER 3

DEVELOPING A GENERIC HERBAL FORMULA

3.1 Introduction

One aim of this study was to develop a novel herbal formula to alleviate or ameliorate menopausal symptoms. The formula was based on the traditional practice of using 'polypharmacy' for the symptomatic relief of menopausal symptoms, i.e. prescribing several herbs, typically four or five, rather than herbs individually. This approach was chosen because the study aimed to determine the benefits of herbal medicine, in the context of traditional practice, whilst working within the framework of a double blind randomised placebo-controlled trial. This method also addressed the Lord's report recommendation for more (CAM) research. A study using a single herb would not have been representative of the current practice of prescribing herbs as part of an individualised formula. Once the formula was completed its specifications were included in the research protocol for review by the university ethics committee (see Chapter 4 and Appendix I). The formula and placebo to be used were also described explicitly in the MLA-164 application (see Appendix VIII) to enable the MCA's panel of experts to form a judgement on issues such as safety, efficacy and quality control. These issues were addressed during the completion of the MLA-164 application by including information, where available, from the literature to form an extensive database on each of the plants. This work has provided a unique record of the processes of developing a herbal formula with supporting data to substantiate the efficacy and safety of the formula.

3.2 Developing a Herbal Formula

The approach that was used to design the herbal formula was based primarily on the traditional treatment approaches used by medical herbalists for menopausal complaints, which are documented in herbal pharmacopoeias. This method was appropriate because the treatment rationale was based on empirical knowledge, thus reflecting the practice of herbal medicine. Scientific articles were also obtained, when available, on *in vitro* and *in vivo* menopause research with herbs and also clinical trials. This helped to provide a further rationale for the inclusion of the herbs and helped to narrow the choice of sixteen initially identified herbs down to five.

While the choice of herbs for inclusion in the formula aimed to reflect traditional usage, the need to develop a single generic herbal formula for all the participants does have limitations due to the standardised methodology. In the UK, herbal medicine is normally prescribed to patients from the synthesis of their symptoms into a unique individual prescription (Adams, 1999). While subjects presenting with menopausal symptoms will often experience similar symptoms such as hot flushes and night sweats, these will vary in severity, and many will present with additional symptoms such as headache, depression and palpitations (Campbell and Monga, 2000). A generic formula is preferable in research to providing individual formulae for patients because the results are easier to interpret, since the number of variables is kept to a minimum. Furthermore, a trial using a generic formula will have a greater possibility of being successful when using a Quality of Life (QoL) questionnaire if the formula is designed to encompass a broad range of symptoms, since patients are more likely to report improvements in their well-being.

The basis of designing a generic herbal formula is problematic since the MCA requires a scientific rationale to justify the inclusion of individual herbs within the formula, and the ratios and dosage regimes used. Historically, the development of herbal medicine has been based on empiricism and not on modern pharmaceutical methods. The limited pharmacological and toxicological data available on herbal remedies restricts the justification for including herbs in a formula. Justification for the dosage and formula based wholly on traditional use may not be accepted as sufficient supporting evidence for safety and efficacy. This is true even when citations are taken from the official herbal pharmacopoeias, such as the British Herbal Pharmacopoeia and the British Herbal Compendium, since the basis of these works comes primarily from practitioner based anecdotal evidence.

There are a number of herbs traditionally used in the treatment of menopausal symptoms, which are derived mostly from empirical work recorded in old herbal pharmacopoeias or practitioner experience (see table 1).

Table 1. Herbs that are cited in herbal pharmacopoeias for the alleviation of menopausal symptoms

Botanical name	Common name	Family	Main use
<i>Achillea millefolium</i> L.	Yarrow	Compositae	Antipyretic
<i>Avena sativa</i> L.	Oat	Graminae	Tonic
<i>Capsella bursa-pastoris</i> L.	Shepherds purse	Cruciferae	Diuretic
<i>Cimicifuga racemosa</i> L.	Black cohosh	Ranunculaceae	Antihydrotic
<i>Daucus carota</i> L.	Wild carrot	Umbelliferae	Antihydrotic
<i>Dioscorea villosa</i> L.	Wild yam	Dioscoriaceae	Adrenal tonic
<i>Eleutherococcus senticosus</i> M.	Siberian ginseng	Araliceae	Adaptogen
<i>Glycyrrhiza glabra</i> L.	Licorice	Leguminosae	Tonic
<i>Hypericum perforatum</i> L.	St. John's wort	Hypericaceae	Antidepressant
<i>Leonurus cardiaca</i> L.	Motherwort	Labiatae	Nervine
<i>Panax ginseng</i> C.A. Meyer	Ginseng	Araliaceae	Adaptogen
<i>Paeonia lactiflora</i> Pall.	Bai Shao	Ranunculaceae	Tonic
<i>Piper methysticum</i> Forst.	Kava Kava	Piperaceae	Anxiolytic
<i>Salvia officinalis</i> L.	Sage	Labiatae	Antihydrotic
<i>Tilia europea</i> L.	Lime flowers	Tiliaceae	Anxiolytic
<i>Vitex agnus castus</i> L.	Agnus castus	Verbenaceae	Hormone regulator

Source: BHP, 1990; BHP, 1983 ESCOP, 1997.

A small number of herbs such as *Cimicifuga racemosa* have been subjected to scientific scrutiny and found to be efficacious for alleviating menopausal symptoms. From the literature review, it was found that *Hypericum perforatum* and *Cimicifuga racemosa* have been clinically proven as beneficial in symptoms associated with the menopause (Boblitz *et al*, 2000) and are used in clinical practice for menopausal complaints. Both herbs also have a good safety profile and pharmacological profile. *Salvia officinalis* has been demonstrated to have antihydrotic activity (Wake *et al*, 2000; Perry, 1996) and according to the herbal pharmacopoeias, is indicated for hot flushes. It is an official drug of ESCOP with a good safety profile. *Glycyrrhiza glabra* has been found to be efficacious in several conditions such as gastric ulcer and hepatitis and is used traditionally in Western and Chinese herbal medicine as a tonic, and as part of formulae aimed at treating menopausal symptoms (Bensky, 1992). It has a good safety profile and its pharmacological properties have been researched. *Dioscorea villosa* has not been subjected to any major research, although its genus 'equivalent' *Dioscorea opposita* (Shan Yao) is used in Chinese herbal medicine for menopausal complaints (Bensky and Gamble, 1992). It is a herb that is used by herbal practitioners for menopausal complaints and has no known contraindication or safety concerns related to its use.

The dosage of the herbal formula was kept within the recommendations given in herbal pharmacopoeias for the therapeutic and safety dosage ranges. *Hypericum perforatum* and *Cimicifuga racemosa* were considered to be the principal therapeutic herbs given the research finding for the treatment of depression and hot flushes. *Salvia officinalis* and *Dioscorea villosa* were used at a lower ratio to *H. perforatum* and *C. racemosa* because traditionally, the dosage ranges used are lower. *Glycyrrhiza*

glabra was used at the lowest dosage. Its main use is as an adaptogen or 'tonic' herb and is used to treat conditions, such as the menopause that are traditionally considered to manifest from exhaustion or the ageing process. Administration of *G. glabra* at dosages greater than eight grams per day has been found to cause hypertension (Bernardi *et al*, 1994) and therefore a dosage was used that allowed a large safety margin.

The chosen formula and the ratio of herbs to be included are shown in Table 2.

Table 2. The herbal formula- stating the botanical name, the quantities proposed and the pharmacopoeia reference.

Herb	% per capsule	Weight per capsule	Dosage per day	Pharmacopoeia reference dosage
<i>Hypericum perforatum</i> L	27.8%	0.125g	1.25g	2-4g/day (BHP, 1983)
<i>Cimicifuga racemosa</i> L.	27.8%	0.125g	1.25g	0.3-2g/day (BHP, 1983)
<i>Dioscorea villosa</i> L.	16.7%	0.075g	0.75g	2-4g/day (BHP, 1983)
<i>Salvia officinalis</i> L.	16.7%	0.075g	0.75g	1-4g/day (BHP, 1983)
<i>Glycyrrhiza glabra</i> L.	11.0%	0.05g	0.5g	1-4g/day (BHP, 1983)

3.3 Placebo

To ensure the double-blind placebo controlled trial remains valid, the herbal treatment and placebo need to be sufficiently matched to prevent the subjects from discovering which treatment they are receiving and inadvertently unblinding the trial. The two treatments need to be similar in size, colour, taste, texture and shape. Matching drugs can be more difficult for liquid medicines than tablets or capsules, because both smell and taste are likely to be noticeable. Capsules are the easiest to match, especially when they are opaque, since visual differences, taste, size, texture and smell, are eliminated. The material that is used as the placebo also needs to be as inert as

practicable. Rice flour was chosen for this study because it is economical and has no known medical benefits in menopausal symptoms. The type of capsule chosen was an 0-sized methylcellulose opaque vegetarian capsule capable of holding 0.45g of the herbal formula and has no known medicinal property that would affect the results of a menopause study.

3.4 Quality control

To ensure patient safety and provide a framework for rigorous research, quality control methods needed to be used throughout the study to provide information on the chemical characterisation of the plants. Medicinal products intended for research and development trials are not subject either to EU marketing or manufacturing legislation, and thus, in principle do not require as rigorous quality control procedures. However, it was agreed in “Rules and Guidance for Pharmaceutical Manufacturers and Distributors” (1996) that medicinal products intended for human use should comply with the principles of good manufacturing practice (GMP) during the manufacture of products intended for use in clinical trials.

Deciding on the type of quality control methods and the specification required for an MCA submission using an MLA-164 application was difficult since no comprehensive information was available from the MCA to instruct the applicant on the types of tests necessary to satisfy their requirements. The MLA-164 document outlines criteria that must be fulfilled in terms of principles and guidelines. To satisfy the requirement of the MLA-164, quality control procedures and safety requirements need to be established and documented by the producer and manufacturer, including procedures relating to harvesting and storage, and identity and stability tests.

3.5 Harvesting and Storage

The main requirements for harvesting and storage are to ensure that drying equipment, storage areas, and vehicles used are clean and free from contaminants. Crude plant material that is unprocessed should be kept in a clean, separate storage area that is ventilated and protected from insects and animals. The time of harvesting, geographical origin, stage of growth, drying and storage conditions and any chemical treatment should be recorded, (Rules and guidance for pharmaceutical manufacturers and distributors, 1996). Specifications for the starting material should include as far as possible:

- Botanical name, including the author, for example, Linnaeus.
- Origin of the plant, including the country and area.
- Cultivation time, harvesting time, and collection procedures.
- Details of any pesticides used.
- Details of the part(s) of the plant used and the stage of growth.
- If the plant material used is dried, the drying system should be stated.
- The plants should be micro-and-macroscopically examined & described.
- Suitable identification tests should be used, including tests for known active ingredients, or markers and reference specimens.
- An assay of active constituents or markers.
- Determination of potential pesticide contamination.
- Tests for insect, fungal and microbiological contamination.
- Test results of heavy metal contamination or adulterants.

Source:(Rules and Guidance for Pharmaceutical Manufacturers and Distributors, 1997).

3.6 Authentication and Documentation

The MCA's requirements for authentication tests and documentation are to ensure that the correct genus and species are obtained, to safeguard patients from potential toxic plants being inadvertently used and to provide a documented history of the drug substance. A botanist, who is able to issue a voucher number, can be consulted for this purpose, since identifying the herbs against a specimen is unlikely to be acceptable. Further measures to confirm the identity include: High Performance Liquid Chromatography (HPLC), Gas Chromatography Mass-Spectroscopy (GC-MS) and Thin Layer Chromatography (TLC).

Guidelines have been given for the labelling of medicinal products in clinical trials, which include:

- Name of the sponsor.
- Pharmaceutical dosage form, route of administration, quantity of dosage units (and name of the product and strength/potency in case of an open trial).
- The batch and/or code number to identify contents and packaging operation.
- The trial subject identification number (where applicable).
- Directions for use.
- State 'For clinical trial use only'.
- The name of the investigator (if not included as a code in the trial reference code).
- A trial reference code enabling identification of the trial site and investigator.
- The storage conditions.
- The period of use (use by date, expiry date or re-test date as applicable) in months/year.
- The warning: 'Keep out of reach of children' except when the product is for use only in a hospital.

Source: Rules and guidance for pharmaceutical manufacturers and distributors (1996).

3.7 Stability Testing

The purpose of stability testing is to establish how long the product can be safely used whilst retaining acceptable levels of quality and efficacy once the container is opened. A requirement of MLA-164 is to ensure that the active constituent(s) and non-characterised compounds (unidentified constituent) in the herb(s) meet limits for degradation set by the International Conference of Harmonisation (ICH, 1996). The tolerances are set at $\pm 10\%$, if the active constituent(s) are not known or, $\pm 5\%$ when the active constituent(s) are known. This criteria set for pharmaceutical drugs applies to herbal products when they are either sold as medicinal products, or used in clinical trials. The MCA's guidelines recommend using a minimum of two batches, preferably on a production scale, or a pilot study scale if this is representative of the scale of production.

Being an organic product, herbal medicine naturally decays through oxidation, and evaporation, especially when the plant material is fresh, or contains volatile oils. Therefore, the chemical profile of each batch will vary. It is desirable to use a single plant batch in a research trial to ensure maximum uniformity of the drug substance, since chemical assays may vary between different batches depending on their origin, growth conditions and the date of harvest (Thieme, 1985). Discrepancies in processing procedures such as time variation between harvesting and storage may further contribute to variations in constituent concentrations and affect quality and uniformity.

The difficulty of meeting the MCA's stability limits set by the ICH was highlighted by Bilia *et al* (2001) who tested the thermal stability and photostability of *Hypericum*

perforatum. Photostability tests found all constituents (flavonols, hyperforins and hypericins) to be photosensitive, whilst long term thermal stability tests revealed low stability of less than four months for hyperforins and hypericins. Even when ascorbic and citric acid were added as antioxidants, the degradation exceeded the ICH limits. In a further study, Sloley *et al*, (2000) found that the chemical profile of standardised *Hypericum* extracts varied substantially in the concentration of various characteristic chemicals, whilst Southwell and Bourke (2001) found seasonal variations of hypericin and pseudohypericin in the range of 100ppm to 5000ppm.

3.8 Stability Program and Test Conditions

During the stability study, the product should be stored at ICH recommended conditions, which is 25 °C/60% relative humidity for the Northern hemisphere. The physical, chemical and microbiological properties should be evaluated, using tests appropriate to the formulation. There is no standard stability criterion utilised by the MCA and justification may be required if certain tests are either omitted or do not meet limits. Most stability studies require physical, chemical and microbiological testing such as:

- i) **Physical tests:** Colour, clarity, closure integrity, presence of particulate matter and particle size, moisture content.
- ii) **Chemical tests:** Active substance assay(s), antimicrobial preservative and antioxidant content(s), degradation product level(s) and pH.
- iii) **Microbial tests:** Total viable count and antimicrobial determination.

The stability studies are usually conducted using normal and accelerated test conditions. Reducing or omitting pesticide residues tests is allowed if the applicant is

able to demonstrate that the herbal drug is grown under strict organic conditions and any potential contamination from adjacent plantations has been eliminated.

A stability study needs to have run for a minimum of 6 months duration at the time of submission. A production batch manufactured post-approval should be placed on long term stability studies (minimum of 12 months) using the same stability protocol and submitted when available. The test methods need to be described in detail and the results summarised, for example, using tables or graphs. A public accredited analyst with prior experience of phytochemical analysis is desirable to meet the quality standards. Samples of each production batch should be retained for at least one year beyond the final shelf life, or two years after the completion of the clinical trial whichever is the longest. Source: Rules and guidance for pharmaceutical manufacturers and distributors (1996).

Table 3. ICH Test Conditions for Stability Studies

Test conditions	Conditions	Minimum time period at submission
Long term testing	25 C ± 2 C/ 60% Relative Humidity 5±%	12 months
Accelerated testing	40 C ± C/ 70% Relative Humidity 5±%	6 months

Testing frequency

Testing is performed normally every 3 months over the first year and every six months over a second year, and then annually if further testing is required.

Microbiological testing needs to be performed to ensure microorganisms are within safety limits or absent for pathological organisms. The European Pharmacopoeia (2001, 4th ed.) provides microbiological limits for microorganisms as follows:

- Total viable count: Not more than 1,000,000
- Fungi not more than 100,000 per g
- Absence of *Escherichia coli*
- Absence of *Salmonella*

3.9 Summary

When developing the herbal formula, consideration was given to the choice of herbs based on traditional use, since this forms the basis of herbal medicine practice. Choosing herbs for a clinical trial based on the outcomes of individual constituents used in *in vitro* studies will not be suitable since the effects will probably be different from whole plant extracts. The formula was developed specifically to address the wide range of symptoms that menopausal women may present with, such as hot flushes, depression, anxiety, night sweats and lethargy. The placebo was adequately matched to prevent unblinding and the filling material (rice flour) was chosen to be as inert as practicable. Quality control procedures were identified for the study that would be appropriate to satisfy the requirements of the MCA, such as harvesting and storage procedures for medicinal plants. The identification, stability and safety testing procedures were developed for the study in preparation for a clinical trial.

CHAPTER 4

RESEARCH STUDY DESIGN

4.1 Introduction

To provide a framework for testing the herbal formula in a double blind placebo controlled trial and to demonstrate to the MCA that the study is methodologically robust, a research study was developed detailing how the project would be implemented. The guidelines for this study design were based on the principles and methods suggested by Pocock (1998), and Friedman (1996), which were then specifically adapted to the needs of this project. Several factors were considered when designing the study, such as ethical considerations, the viability of acquiring sufficient patients and ensuring the study is well designed to avoid biases and flawed research methodology. The following tasks were developed specifically for this study and provided a unique record of the prerequisites of a clinical trial for assessing the efficacy of herbal medicine in the treatment of menopausal symptoms:

- The key elements to produce a research protocol for subsequent assessment by an ethics committee.
- The production of an operations manual to enable clinicians to administer the study.
- Recruitment procedures to ensure that sufficient numbers of patients are entered into the study.
- The choice of appropriate questionnaire tools to assess patients' response to treatment intervention.

- The calculating of the power of the study to estimate the number of patients required, ensuring that treatment differences are detected.
- Randomisation procedures to reduce the potential for bias.

4.2 Research Protocol

To gain initial approval for the clinical trial, a protocol outlining the aims and objectives of the study was submitted to the School of HeBES ethics committee. The protocol is attached (Appendix I). The Declaration of Helsinki (WMA, 1964) provides a framework for ethical consideration, however each committee will have its own guidelines to follow. Clinical trials share several core features that need to be addressed to enable an ethics committee to reach a decision (see below).

The main features of a research protocol are listed below:

- Background to the study
- Aims of the project
- Research question(s)
- Methodology
- Patient recruitment
- Inclusion criteria
- Exclusion criteria
- Data collection procedures
- Data analysis techniques
- Planned research outputs
- Timescale for the proposed research
- Patient consent

The protocol developed for this research forms the basis of the study and essentially comprises of two key sections: the *methodology*, which is specific to the study and *patient consent* which, whilst being pertinent to the study, shares many features that

are applicable to other clinical trials, since patients' rights will be in accordance with the Helsinki agreement.

4.3 Background

The background to the study enables both the ethics committee and the MCA to understand why the work is necessary and what it potentially offers in terms of new research findings, since it would be unethical to subject patients to 12 weeks of medication if the design offered nothing different from previous research. An alternative to HRT is desirable since, as stated previously, for many women, HRT may not be a viable option due to contraindication and concern for the side-effects. The aim of the study stated in the research protocol is to determine whether the herbal formula is efficacious for the alleviation of menopausal symptoms.

4.4 Methodology

The protocol includes a methodology section outlining how the study will operate. A set of inclusion and exclusion criteria was developed specifically for menopausal women to ensure that only patients suitable for the trial were enrolled. The key criterion was to ensure that patients were actively experiencing menopausal symptoms, rather than simply being menopausal. This necessitated the development of a symptom scoring list to delineate subjects who were eligible for the study, from those who were not. Patients with potentially life-threatening medical conditions, mental health problems or patients receiving certain prescription drugs (Appendix I) would be screened out by an initial telephone administered health check to avoid ethical and medical dilemmas. The treatment duration that patients would be exposed to was set out in the proposal to enable committee members to determine whether the

proposed treatment regime was safe and ethical. The length of treatment is an important consideration since it can determine the outcome of the study, as insufficient time could produce a false-negative, whilst a study that is too long will require more resources. Furthermore, it would be unethical to expose patients longer than was necessary to both medication and trial participation.

4.5 Patient Consent

Patient consent forms were produced specifically for this study to ensure patients were not unwittingly subjected to any undue risk or denied their rights, as set out in the Helsinki agreement. The patient consent forms described the nature of the study and explained each aspect of subject participation, including the potential benefits and risks that they would be exposed to. It was made clear to the subjects in the consent form that they would receive either the placebo or the new treatment, and that the placebo had no benefit. This was to emphasise to subjects that there was an equal possibility of receiving the placebo, which would have no therapeutic benefit. The standard clause section was included because it is important to state the rights that patients have and to clarify what they are agreeing to in the consent letter (Appendix I).

4.6 Operations Manual

The operations manual was designed specifically for this study to enable the practitioner to administer the trial in a step-by-step process through each patient visit. The information contained within an operations manual should strive to be as comprehensive as possible, so that every conceivable eventuality is considered. Clear criteria of the entry requirements and procedures to be followed by the practitioners

are important. The operations manual (Appendix II) used in this study is partly an extension of the protocol since the main points of the protocol (background, patient screening and treatment) are restated in the document, but with more emphasis on how the study should be conducted.

4.7 Practitioner Instructions

Instructions were developed to provide information on how long the consultations should last to ensure that the trial would be kept to schedule. The operations manual also sets out procedures for checking patient eligibility, obtaining informed consent, administering the questionnaires, dispensing the medicine, and providing patients with adverse event reporting cards to monitor potential side-effects.

4.8 Case History Notes

Patient case history notes were developed specifically for the research trial. The case history notes were designed to provide information in four areas:

1. Personal details
2. Demographic information
3. Screening questions
4. Patients' medical status

The patient's personal details (name, address, telephone number) were included to enable practitioners to identify patients for appointment purposes and to ensure that patients could be contacted in the event of an emergency. The demographic questions (weight, height, marital status, occupation, number of children, cigarette smoking, alcohol usage and exercise) were incorporated to allow comparisons between patient groups to check for homogeneity and to enable comparisons with other menopause study populations. Screening questions were developed for the study to ensure only

subjects that met the entrance criteria were enrolled. The screening was to be repeated again at the initial appointment to recheck eligibility, since patients may have subsequently become ineligible during the intervening period.

The patient's health status would be evaluated from a systematic enquiry of their medical history including: the cardiovascular, respiratory, gastrointestinal, urological, musculoskeletal, nervous and reproductive system, and by checking their blood pressure. Physical examinations would be conducted only if a medical need arose.

A method of pre-screening patients by telephone was developed for the study to ensure that only eligible participants were enrolled onto the clinical trial. This type of pre-screening is useful to save practitioner time and is therefore more economical.

4.9 Patient Recruitment and Appointments

It is necessary before a clinical trial can commence to have recruited enough subjects for the study. A study with too few participants is unlikely to have sufficient power to detect any real treatment difference and therefore a strategy for patient recruitment needs to be employed. An advertising strategy using local newspapers and radio is one method of raising public awareness. The cost of newspaper advertising (Table 4) can be considerable and other strategies such as displaying posters in local hospitals and GP surgeries should be considered to recruit patients.

Table 4. Typical costs of newspaper advertising

Newspaper	Type	Size of Advertisement	Readership	Cost of single advertisement
Scotsman	Daily	¼ page	209,000	£1,244.40 + vat
Evening News	Daily	¼ page	173,000	£1,152.60 + vat
Herald & Post	Free paper	¼ page	260,000	£999.64 + vat
South Wales Echo	Daily	¼ page	235,000	£1,119.28 + vat
Wales on Sunday	Weekend	¼ page	199,000	£ 408.00 + vat
Western Mail	Daily	¼ page	200,000	£826.00 + vat

Posters can help to attract the attention of potential subjects, and leaflets situated nearby for patients to take are useful to provide more details for the interested reader. The poster (Appendix III) was developed for the menopause study with the aim of being eye-catching and the leaflet (Appendix IV) was designed to provide additional information on the study.

To enable patients to be recruited and studied for 12 weeks, time allocation slots were devised (see Appendix V) to enable patients to be enrolled onto the study and treated sequentially. Four appointment days were given which enabled the patients to be treated and reassessed as follows: 1st appointment (week one), 2nd appointment (week 2), 3rd appointment (week 7), 4th appointment (week 12). In the example of this process in Appendix V, 45 patients (groups A-F) can be enrolled and assessed on four occasions over a four-month period.

4.10 Questionnaire Development

To determine a patient's response to medical intervention, an instrument was required that would accurately measure any treatment induced changes. There is no objective instrument that can determine improvements in menopausal symptoms, since hormonal levels are not reliable predictors of either menopausal status or symptom

severity (WHO, 1996). One method that can be used to assess treatment interventions is a Quality of life (QoL) questionnaire. By definition, QoL is a subjective parameter and direct questioning is therefore a simple and appropriate way of gathering information about how patients feel and function. The content of QoL instruments typically concern psychosomatic factors (Table 5). These subjective QoL instruments should not be perceived as inferior to objective measurements. For example, QoL instruments have been found to be superior to conventional rheumatological measures as predictors of long-term outcomes in rheumatoid arthritis in terms of both morbidity and mortality (Wolfe and Cathey 1991; Leigh and Fries, 1991)

Table 5. Typical dimensions of quality of life instruments

Physical function-	Mobility, self care
Emotional function-	Depression, anxiety
Social function-	Intimacy, social support, social contact
Role performance-	Work, housework
Pain-	Frequency, severity
Other symptoms-	Fatigue, nausea, disease specific symptoms

When choosing a QoL questionnaire, it is important to consider how well it will perform and this can be determined from its psychometric properties (see Table 6). An instrument needs to be reliable, i.e. it must produce the same results on repeated use under the same conditions. This can be examined by test-retest reliability. An instrument needs to be valid, i.e. it measures what it was designed for. Validity is initially checked by face validity, i.e. by asking whether the instrument seems to cover the full range of relevant topics. A more formal approach is to examine construct validity, which is concerned with the pattern of relationships of the QoL instrument with other more established measures, for example, laboratory or clinical measures. Sensitivity to change is a crucial requirement for a QoL instrument since a subtle response may be undetected if the instrument lacks sensitivity. Sensitivity is an

important aspect in any QoL questionnaire since the more responsive an instrument is, the greater its ability to detect treatment effects, and thus the sample size used can be lowered.

Table 6. Factors influencing the selection of instruments

Measurement property	Type of instrument	Methods of administration
Validity	Generic	Self-administration
Reliability	Condition specific	Interviewer administration
Responsiveness	Dimension specific	Cultural setting

Source: (Fletcher *et al* 1992)

There are two basic types of QoL questionnaire: generic and condition specific. A consideration for this study was whether to use a generic or condition specific questionnaire as both have advantages and disadvantages (see Table 7). Generic instruments cover a broad range of QoL dimensions in a single instrument. Amongst the more commonly used generic tools are the Sickness Impact Profile, the Nottingham Health Profile, Quality of Well-being Scale and the Short form or SF-36 Health Survey (Schneider *et al*, 2000). These generic measures have the advantage of covering multi-dimensional aspects of quality of life in a wide range of health problems, although evidence suggests they may be less responsive to treatment induced changes (Fitzpatrick *et al*, 1992).

Table 7. Benefits and shortcomings of Generic as compared with Condition Specific questionnaires

	Generic	Disease/Treatment Specific
Comprehensiveness & scope	Comprehensive & wide in scope	Deliberately narrow in scope
Applicability	General applicability over populations; low in precision	Targeted to a specific patient group, condition or treatment; high in precision
Generalisability	Can be generalised over populations and used for comparisons, norms or reference values available	Focuses on its target and cannot be used for comparisons; norms or reference values not applicable
Familiarity	Well-known with a wide spread use over many years	Unfamiliar, used to a limited extent
Relevancy	Too general for a specific patient population; low in patient and clinician credibility	Highly relevant to its target population; credible to patient and clinician
Responsiveness	Less responsive to treatment induced changes	Highly responsive in detecting small, clinically relevant changes
Practical, motivational considerations	Lengthy, time consuming, less acceptable	Short, acceptable

Source: (Wiklund and Dimenas, 1990)

Condition specific instruments have the potential benefit of reducing patient burden by being more concise, increasing acceptability by including only relevant dimensions and they are more responsive to health interventions. A disadvantage is that they may inadvertently exclude some health effects by being too narrow. Menopause specific instruments available include the Women's Health Questionnaire (WHQ) (Hunter, 1994), the Greene Climacteric Scale (GCS) (Greene, 1998), Blatt-Kupperman Index (BKI), (Alder, 1998) Menopause Rating Scale (MRS) (Schneider, *et al* 2000), Menopause Symptom List (MSL) (Perz, 1997) and the Menopause-specific quality of life instrument (MENQOL) (Hilditch *et al*, 1996).

The ability of QoL instruments to detect treatment-induced changes over time was examined by Wiklund *et al* (1998) in a study evaluating the effects of oestrogen therapy. The Kupperman Index, the Visual Analogue Scale (VAS), the Women's Health Questionnaire (WHQ), the McCoy Sex Scale, the Psychological General Well-

being Index (PGWBI) and the Nottingham Health Profile (NHP) (Table 8) were evaluated for size effect differences to oestrogen therapy. The menopause specific QoL instruments were found to be more responsive to treatment than the generic QoL questionnaires.

The Kupperman index is a menopause specific QoL questionnaire that has been used in early menopause studies and is sensitive to change. It was developed in the 1950's and later revised by Blatt, into the Blatt-Kupperman index (BKI). It is limited by focusing primarily on hot flushes, whilst factor analysis has only established test re-test reliability (Hilditch *et al*, 1996). Critiques of the BKI, such as Greene (1998), have stated that menopausal symptoms are a multifaceted phenomenon with differing aetiology and therefore should be measured and summated to yield scores within categories like somatic, vasomotor and psychological rather than summing all values into a single score as in the BKI. Alder (1998) considers the BKI wording as archaic and regards its application as being no longer viable.

Table 8. Treatment effect differences for generic and menopause specific QoL questionnaires

Total Score	Oestrogen	Placebo	Treatment comparison
Kupperman Index [†]	2.46	0.84	1.62
Visual Analogue Scale (VAS) [†]	1.24	0.34	0.90
Women's Health Questionnaire [†]	1.09	0.32	0.77
McCoy sex scale*	0.36	0.01	0.35
Psychological General Well-being Index *	0.69	0.34	0.35
Nottingham Health Profile*	0.69	0.20	0.49

Source: (Wiklund *et al*, 1998)

[†] Menopause specific QoL questionnaire

* Generic QoL questionnaire

The Greene Climacteric Scale (GCS), the Menopause Rating Scale (MRS), the Menopause Specific Quality of Life instrument (MENQOL) and the Women’s Health Questionnaire (WHQ) are all menopause-specific quality of life instruments that use different subscales to categorise questions (Table 9). The Greene Climacteric scale was developed to focus on core climacteric symptoms and consists of 11 questions. It therefore has an advantage over the 36-question WHQ by being easier to administer and analyse, although being shorter, it provides less information on different symptoms. The MRS has similar advantages and disadvantages to the GCS, again having only 11 questions. Its psychometric properties have been established but it has not been used as widely as the WHQ in clinical trials. MENQOL was developed in 1996. This questionnaire has been subjected to factor analysis for reliability and validity, and has been shown to be sensitive to change (Hilditch, *et al* 1996). One minor criticism of MENQOL by Hilditch *et al* (1996) is that the construct validity for the somatic domain was found to be low. However, overall, the merits for this menopause specific QoL instrument are satisfactory. Table 9 shows the subscales used in the menopause specific QoL questionnaires.

Table 9. Subscales used for the factorially derived questionnaires

WHQ (36) [†]	GCS (11)	MRS (11)	MENQOL (30)
Vasomotor	Vasomotor	Somatic	Physical
Somatic	Somatic	Psychological	Psychological
Anxiety	Anxiety	Urogenital	Sexual
Depression	Depression		Working life
Cognitive			
Sleep			
Sexual function			
Attraction			
Menstrual symptoms			

[†] The number of questions contained in each questionnaire

4.11 Questionnaires Chosen for the Clinical Trial

The WHQ has been used in several clinical trials to monitor treatment-induced changes over time. It is a 36-item self-administered menopause specific instrument that provides a detailed examination of minor psychological and somatic symptoms experienced by menopausal, perimenopausal and postmenopausal women. The items are combined into nine dimensions: depressed mood, somatic symptoms, cognitive difficulties, vasomotor symptoms, anxiety/fears, sexual functioning, sleep problems, menstrual symptoms and attractiveness. It has been subjected to factor analysis, which correlates symptom clusters to form groups (Hunter, 1995). It is then possible to construct an instrument consisting of several separate subscales that measure different aspects of the symptom picture (Greene, 1999). It was developed in England, and has been demonstrated to be valid in terms of reliability and sensitivity and was chosen for this study as it offered a menopause specific QoL tool sensitive to treatment effects with proven psychometric properties (see Appendix VI).

A second measurement tool was chosen for the study to provide a further evaluation of potential therapeutic response based on the patient's own personal experiences. This may potentially provide a more sensitive measure of treatment induced changes compared with the WHQ since patients will be able to choose the symptoms that are affecting their lives and then evaluate any changes that have occurred. Furthermore, it enables a perspective to be gained from patients that may not be acquired from an 'off-the shelf' pre-set questionnaire. The Measure Yourself Medical Outcome Profile (MYMOP) was developed by Patterson (1996), and is a patient specific measure that allows individual patients to choose the symptom to be monitored. While MYMOP is not specific to the menopause, it attempts to incorporate patient's personal experiences of illness into the measurement process. The patient is involved in

deciding which symptoms or aspect of their illness are affecting them the most. Patients choose an activity that they consider important and rate how this activity is affected by their health problems. Patients also rate their well-being using a likert-scale over a 7-day period (see Appendix VII).

4.12 Data Analysis

The data generated from the questionnaire(s) can be analysed using the Statistical Program for Social Science (SPSS). Non-parametric tests (Wilcoxon matched-pairs signed-rank test and the Friedman test) can be used to compare patient change over time.

4.13 Statistical Power of the Study

The purpose of calculating the power of a study is to maximise, as far as practicable, the chances of finding a real and important clinical effect if it is present, and to be fairly certain that a negative outcome indicates no real treatment difference exists, thus reducing the possibility of a false-negative. Sample size calculations are important both practically and ethically. A study with an overlarge sample may be deemed unethical through involvement of unnecessary patients and will incur extra costs, whilst a study with too few patients will be unable to detect clinically important effects (Altman, 1980).

To calculate a sample size, the treatment differences need to be known, or at least there should be a good idea of where they may lie. Often, before a full-scale clinical trial is conducted, pilot studies are used to derive toxicological information and treatment scores can be gathered to enable an estimate of the sample size required. For

this study, no information was available to estimate the size of any treatment effects with the herbal formula. The sample size was calculated by extrapolating from the treatment differences found in a study by Murkies *et al* (1995), which used soya as the treatment for menopausal symptoms and wheat flour as the placebo. Calculating the sample size based on the treatment effects of HRT trials would have been unsuitable and misleading since hormone replacement therapy is not comparable with herbal medicine because our study was not attempting to replace depleted endogenous oestrogens with exogenous oestrogens. Murkies's study shared similar characteristics to the proposed trial in that both treatment and placebo were derived from plant material (soya and wheat flour). This trial reported the incidence of hot flushes to be significantly reduced in the group receiving soya (40% reduction) compared with the placebo group given wheat flour (25% reduction). Thus $p^1 = 25$ and $p^2 = 40$, where p^1 is the percentage of successes expected from one treatment and p^2 is the percentage of successes on the other treatment which one desires to detect as being different from p^1 (Pocock, 1998).

To calculate the trial size, some parameters need to be chosen for the equation.

- 1) The level of significance for the statistical test needs to be stated.

Using a Wilcoxin signed-rank test to compare the scores between the treatment and placebo groups, a 5% significance level was chosen as showing evidence of a treatment difference denoted as α .

α = the level of the significance test used for detecting a treatment difference. A *type I error* (α) results when it is falsely concluded that there is a difference between the groups. The α value represents the pre-established acceptable probability of type I error (often set at $\alpha = 0.05$).

- 2) The type of result anticipated with the standard treatment needs to be determined.

Wheat flour was chosen as the standard treatment, based on the findings by Murkies *et al* (1995) who found a 25% improvement in vasomotor symptoms ($p^1 = 25$).

- 3) A decision needs to be made on what size of treatment differences is important to be detected and with which degree of certainty.

This depends on what is the smallest difference that is considered of such clinical value that it would be undesirable to fail to detect. Thus a percentage can be set dependent on the clinical importance, for example, 50, 60, 70, 80, 90, 95%. For this calculation, a 90% confidence level was set.

β , a *type II error* denotes the mistake of concluding that there is no difference between groups, i.e. ($p^1 - p^2$) when a clinically important difference exists, and the probability of it occurring is represented by β often set between 0.05, 0.1, 0.2 and 0.5.

$1 - \beta$ = the degree of certainty that the difference $p^1 - p^2$, if present, would be detected (often at set $1 - \beta = 0.90$).

The required number of patients for the trial, n , is obtained using the following formula where $p^1 = 25$ and $p^2 = 40$.

$$n = \frac{p^1 \times (100 - p^1) + p^2 \times (100 - p^2)}{(p^1 - p^2)^2} \times f(\alpha, \beta)$$

where $f(\alpha, \beta)$ is a function of α and β , the value of which is derived from Table 10.

Table 10. Values of $f(\alpha, \beta)$ to be used in formula for required number of patients

		β (type II error)			
		0.05	0.1	0.2	0.5
α (type I error)	0.1	10.8	8.6	6.2	2.7
	0.05	13.0	10.5	7.9	3.8
	0.02	15.8	13.0	10.0	5.4
	0.01	17.8	14.9	11.7	6.6

Source: (Pocock, 1998)

Therefore,

$$n = \frac{25 \times 75 + 40 \times 60}{(-15)^2} \times 10.5 = 199.5 = 200 \text{ patients required for each group}$$

It was found from a power calculation test using a 0.05 level of significance, that a minimum of 200 patients for each treatment group is necessary to be able to conclude at a 90% confidence level that a genuine treatment effect has occurred.

4.14 Randomisation

To minimise bias either knowingly or unwittingly, patients enrolled onto the study need to be allocated treatment in such a way that the clinical team involved is unaware of which type of treatment patients are receiving. One method is to assign random numbers to patients enrolled on the study.

For allocation of two treatments, odd and even numbers can be used to indicate treatments A and B respectively. From Table 11, an arbitrary number is chosen as a starting point and also the direction in which to read the table. For example, the first 10 two-digit numbers from a starting place in column 4 are 95, 93, 8, 13, 98, 88, 78, 39, 36, 30 which translate into the sequence 'A A B A B B B A B B' for the first ten patients.

Table 11. Random numbers list

83	97	83	53	56
20	68	35	73	83
52	45	84	95	85
82	52	56	93	80
39	71	97	8	62
99	72	79	13	36
89	54	34	98	96
43	99	69	88	52
02	78	09	78	17
16	84	89	39	17
14	44	24	36	23
41	20	39	30	87
94	77	75	77	18
81	24	33	39	93
71	86	22	01	11

The weakness of this method is that because the numbers are random, A and B will not be split evenly. Thus, more patients could be given the placebo rather than the treatment. For a small sample size, this could mean a false-negative, i.e. a real undetected treatment effect. The probability of a random numbers list creating unbalanced treatment groups is shown in Table 12.

Table 12. The probability of imbalances occurring in two treatment groups for various trial sizes

Total number of patients	Differences in numbers with a probability of 0.05	Differences in numbers with a probability of 0.01
10	2:8	1:9
20	6:14	4:16
50	18:32	16:34
100	40:60	37:63
200	86:114	82:118
500	228:272	221:279
1000	469:531	459:541

Source: (Pocock, 1998).

Random number lists can be checked to see if the table generates any serious imbalances. If this happens, a new list can be generated. Block randomisation (also called restricted randomisation) is another method to ensure the treatment group split is similar.

4.15 Summary

The production of a research protocol needs to cover all the major elements of the study in order to inform the reviewer of the aims and objectives, and to be able to demonstrate that the work is feasible and ethical. This was achieved by producing the protocol based on the principals of the Helsinki agreement and the research guidelines of the School of Health, Biological and Environmental Sciences. The operations manual is an essential document to enable clinicians to implement the study uniformly and therefore avoid clinical errors occurring. This task was accomplished by stating the aims and objectives of the trial and providing detailed instructions for the clinicians, and developing screening questions and case notes specifically for the subjects being investigated. Patient recruitment is a crucial aspect of any research project since difficulties may be encountered in acquiring sufficient patient numbers for a trial. The costs of advertising were investigated and they were found to be relatively high. Therefore, consideration needs to be given to the considerable financial resources required in advertising if the research budget is limited. Recruiting patients by advertising in GP's surgeries is one method of both reducing advertising costs and sourcing potential subjects.

From the preliminary background research it became apparent that there were no objective assessment tools available to measure symptom changes in menopausal women. It was found that questionnaires could provide a useful tool to assess treatment interventions accurately and sensitively, which can also be more reliable than objective tools. This study found that there are several QoL questionnaires available to assess changes in menopausal symptoms. It was determined from examining the psychometric properties of each questionnaire that the WHQ was the

most appropriate for the study. Calculating the number of patients required for the study is essential to provide meaningful data from the statistical results. A power calculation was performed using existing data from a similar study to determine the number of patients for this study. It was found that 200 patients per treatment group were necessary to detect a genuine treatment effect. Randomisation procedures were developed to avoid biases with treatment allocations. It was found that the method of patient randomisation could be achieved by the use of a random numbers list. This method can also take the form of a software package specifically designed for the purpose.

CHAPTER 5

CLINICAL TRIAL APPLICATION TO THE MEDICINES CONTROL AGENCY

5.1 Introduction

The preparatory work for this study, which included the research design and methodology was undertaken, in part, to demonstrate to the University ethics committee that the study was both feasible and ethical and that the study was at a stage where it could be implemented. This initial work also provided the framework for the completion and submission of the MLA-164 application to the MCA in order to seek permission to conduct the clinical trial.

Clinical trials utilising herbal medicines present a particular difficulty for the MCA to evaluate because the MLA application forms are designed for pharmaceutical drugs, and not complex herbal products. The latter contain a multitude of constituents, some of which have not been identified and the majority of those identified have not had their pharmacological properties established. The rationale for the herbal intervention, choice of herbs, stability studies and the research design, as discussed in earlier chapters, are an integral part of the submission. This chapter elaborates on the procedures necessary to complete a MLA-164 application and the particular problems associated with a submission using herbal medicines rather than a single chemical compound. A 54-page MLA-164 application (Appendix VIII) was completed for this study in order to gain approval from the MCA to conduct a clinical trial, and in doing so provides a novel insight into an area of research, which so far has been poorly understood.

5.2 The Medicines Control Agency's Remit

The role of the Medicines Control Agency is primarily to safeguard public health by ensuring that all medicines on the UK market meet appropriate standards of safety, quality and efficacy. This remit also applies to medicines given to patients enrolled onto clinical trials. The control of medicines in the UK for marketing or clinical trials purposes is arranged through a system of licensing and conditional exemptions which have been established in EC legislation and the Medicines Act 1968. Licences or exemption certificates are only issued once the criteria for the safety, efficacy and quality of the product are satisfied. Restrictions are placed on the claims made in promotional advertising of the medicinal product. The MCA is also required to monitor the safety of licensed medicinal products and to take action when adverse effects are recognised. The MCA's responsibilities, as an Executive Agency of the Department of Health, are to the Secretary of State for Health.

5.3 Clinical Trial Exemption Scheme

Previously, all new active substances were evaluated under a clinical trial certificate (CTC). In 1981, a new scheme was introduced, called the Clinical Trial Exemption Scheme (CTX) or the Doctors and Dentists Exemption Scheme (DDX) that were aimed at speeding up the application process. The key point is that a manufacturer's licence is no longer required for a clinical trial. To obtain a CTX certificate, the supplier of the therapeutic agent needs to notify the MCA of their intention to provide a medicinal product for a clinical investigation. Also the application should be supported by pharmaceutical data and pre-clinical safety data, usually based on animal testing. The CTX scheme is computer based, and information submitted by the

applicant is recorded on disc and assessed by a team of doctors, pharmacists and scientists. The assessment time is normally 35 days but can be extended by another 28 days if required.

5.4 Clinical Trial Application Forms

Research trials are submitted for scrutiny to the MCA using an MLA-164 CTX application or a MLA-162 DDX application. These two documents are distinct in their requirements. An MLA-162 (DDX) is aimed at research conducted by doctors and dentists who are the sole suppliers of the drug. This comes under the Provisions of the Medicines Exemptions from Licences, Special Cases and Miscellaneous Provisions order 1972. This DDX application has to be submitted by a registered medical practitioner. An MLA-162 application requires less pharmacological, toxicological and safety data than an application made via a MLA-164. The requirements for pre-clinical safety data, technical specifications and trial design specifications are considerably reduced using an MLA-162 application, and therefore has a financial advantage to an MLA-164 based study. However, for this route to be followed, a doctor needs to be the sole supplier of the drug without any commercial involvement and a doctor has to directly oversee patient care. For the purposes of this study, the supplier is the research team (Neal's Yard Remedies) and the herbal 'drug' would be administered by medical herbalists without the involvement of a doctor and therefore an MLA-164 application is to be used.

An MLA-164 requires the applicant to submit, amongst other criteria, data on the pharmacokinetics, pharmacodynamics, pharmacology, toxicology, and drug stability.

An application through this route will require greater time and expenditure but is taken as a measure of the quality of a study by editors of peer reviewed journals.

5.5 MCA Requirements

The MCA requires that all plant material is authenticated to ensure that the herbs are correctly identified, to avoid the wrong plant species being administered. A further safety requirement is that each herb should be shown to be non-toxic, both on an individual basis and when used in combination with other herbs. The herbal product needs to be shown to be stable over time without deteriorating into harmful compounds. The process of ensuring the herbs are stable and free from toxic substances becomes more complex and costly with the increasing complexity of the formula. The cost of toxicological testing can be prohibitive, especially for a poly-herbal formula. A five herb formula was used for this study to reflect the current practice within herbal medicine of using polyformulas rather than a single herb formulation.

The MCA's documentation is not precise in its technical requirements, and therefore, meetings with the MCA's representatives were conducted to obtain clarification. Drugs have to be demonstrated to be stable over time within a certain degradation limit of its constituents. The stability specifications limits for constituent degradation have been set by the ICH (1986) for herbal remedies. However, these specification limits have been shown to be unworkable by Bilia (2001) and this issue was addressed at one of the meetings. The MCA suggested that they may provide some leeway on this issue, but did not specify the degree to which they would allow the limits to be extended. A further requirement discussed was the need to identify the active

constituents of each herb and a rationale for the pharmacological action of a polyformula. The difficulties of this task were outlined as currently only a minority of constituents have so far been identified in the herbs proposed for the formula. This issue has been discussed in chapter 3. The question of the need for animal testing was raised at a meeting to determine whether this would be a requirement as both the NIMH and Neal's Yard Remedies are explicitly opposed to animal testing. The outcome was not entirely satisfactory since the MCA panel expressed differing viewpoints, although the lead consultant indicated that animal testing would probably not be necessary.

5.6 Completion of the MLA-164 Application

An MLA-164 application is set out into two main sections. The first section relates to the study design, drug composition and manufacturing processes. The details of the proposed trial were stated in the MLA-164 (Appendix VIII) and included: the study aims, length of treatment and the duration of the study, number of subjects, inclusion, exclusion and withdrawal criteria to be used, safety monitoring procedures, formulation of the drug and placebo, dosages and the age range of the patients.

The second section relates to the scientific supporting information, which has to be supported under headings such as developmental pharmaceuticals. The herbal formula was not a new entity and had not undergone the usual developmental procedures of a pharmaceutical drug. Instead, this section was completed, based on the therapeutic uses of the herbs, to justify their inclusion in a formula to treat menopausal complaints.

The manufacturing processes were described in the MLA-164 document after consultation with the proposed company to produce the herbal capsules, which included a description of the manufacturing and quality control procedures used, such as grinding methods, handling procedures for the raw material and the plants traceable history.

A vegetable drug monograph (i.e. a detailed morphological description of each plant and their constituents) was provided, based on information available from herbal pharmacopoeias and herbal monographs. Often information stated in previous sections of the MLA-164 document, such as chemical constituents, had to be restated again as many sections overlapped in their content.

Control tests on the finished product needed to be undertaken. This task was to be subcontracted to a UKAS public analyst who would perform quality control tests based on the tests and specifications in the BHP (1990), which was to include microscopic and macroscopic identity checks, ash value determination, microbiological tests, heavy metal tests, and chromatographic tests.

Stability tests were to be undertaken by a UKAS accredited public analyst. The types of tests and specification necessary to demonstrate stability were not stated in the MLA-164 document. The tests were based on the criteria stipulated by Chauhan and Agrawal (1999) and included stability tests for:

- Capsule appearance
- Capsule powder appearance
- Average weight

- Moisture content of capsule powder
- pH of 2% aqueous suspension
- Disintegration time
- TLC and HPLC analysis to monitor changes in chemical profile

A description of the pharmacological and toxicological studies of the herbs was required. An extensive literature search was conducted to source bibliographic information on each herb since the MCA will, in principle, accept bibliographic information to support an application. The information that was required included:

- Actions of the plants relevant to the proposed therapeutic use
- Drug interaction
- Toxicological studies
- Mutagenicity
- Carcinogenicity
- Reproductive toxicology
- Pharmacology

Hypericum perforatum and *Cimicifuga racemosa* have both been the subject of patient and animal studies, and justifying their therapeutic action was made possible by extracting information from the various studies that have been performed. However, there was no data available for the mutagenic, carcinogenic or reproductive toxicological effects of *H. perforatum*. *C. racemosa* did not have any supporting information on drug interaction, pharmacokinetics, carcinogenicity studies and reproductive toxicology. *Salvia officinalis* had sufficient information available to

support the claim for its therapeutic action, although there were no pharmacokinetic and toxicological data available. *Dioscorea villosa* had no data available to support the criteria in the pharmacological and toxicological sections. The basis of the inclusion of *D. villosa* would rest on its established use status. *Glycyrrhiza glabra* is an official drug of the British Pharmacopoeia (2001) and its actions have been demonstrated. The pharmacological, pharmacokinetic and toxicological properties have been established, although no information is available for mutagenic, carcinogenic or reproductive toxicological effects. It was stated in the document 'No data available' when there was no information available in the pharmacological section. A meeting with the MCA was arranged to clarify the types of data that would be essential for the application. However, their representatives were unable to specify exactly which tests and supporting information would be necessary to fulfill the pharmacological section. It was suggested that reproductive toxicology data may not be necessary given that the subjects will be infertile. Similarly it was suggested that carcinogenic data may not be necessary for a short-term study as proposed, whereas for marketing purposes, LD-50 toxicology data would probably be a requirement.

5.7 Summary

Considerable preliminary work was carried out before submitting a clinical trials application to the MCA to ensure that their requirements were achievable within both budgetary and time constraints. The CTX forms appeared to be specifically designed for pharmaceutical drugs. Translating the MCA's safety requirements for herbal medicines was problematic given the lack of clarity on the types of tests and specifications needed. Attending meetings with members of the MCA was valuable and was advisable, given the potential for a submission to be rejected. The completion

of the MLA-164 application (Appendix VIII) provided a novel insight into the requirements for an herbal medicine study, and the difficulties that may be encountered with the application process.

CHAPTER 6

HEAVY METAL ANALYSIS

6.1 Introduction

Heavy metal analysis is an important aspect of quality control and is a requirement of the MLA-164 application to ensure the plant material is not contaminated with toxic metals. It is important to analyse herbs to ensure they are not contaminated with harmful metals such as cadmium, lead and mercury, since contamination of medicinal herbs is always a potential risk, as was reported by Bayley *et al* (1995). Lead, cadmium and mercury are all harmful to humans. Cadmium is toxic and accumulates in the body throughout a lifetime. Lead is toxic and has been shown to exert toxic effects on the CNS, reproductive, renal, haematopoietic and immune systems (Weeden, 1984), and it has been identified with impaired I.Q. (Tong *et al*, 1996). Heavy metal contamination of herbs can occur either during cultivation or the subsequent harvesting and processing procedures. Therefore, a medicinal herb, which is cultivated on soil that is relatively free from heavy metal ions, cannot necessarily be guaranteed to be free of contaminants at the final stage of production.

Inductively Coupled Plasma Atomic Emission Spectroscopy (ICP-AES) is a reliable analytical technique for the determination of metals in plants (Kos *et al*, 1996). Heavy metals analysis was conducted using ICP-AES to determine if the herbal material could meet the guidelines for an MLA-164 application. A total of 16 herb samples, eight *Hypericum perforatum* L. and eight *Salvia officinalis* L., were analysed for the heavy metals: lead, cadmium, mercury, copper, zinc, nickel, and chromium.

6.2 Materials

Herb samples of *H. perforatum* and *S. officinalis* were obtained from private and commercial growers in the UK and Southern Europe. Samples obtained in the UK were from London (Enfield and Finchley), Dorset, Leicestershire, the Scilly Isles and Kent. European herb samples were obtained from Bosnia, Spain, Hungary, Turkey and Albania. High purity nitric acid (69%) was obtained from the company BDH and the metal ions standards were obtained from Merck.

6.3 Methods

A sample of each herb (2g dry weight) was placed in a Teflon beaker and 50 ml nitric acid (69%) were added. The beakers were placed in a sand bath at 90°C and left overnight in a fume cupboard to digest the herb material. 20 ml of nitric acid (10%) were then added to dissolve the dried residue using a glass rod. The beaker contents were filtered through a Whatmans No.41 filter paper and washed through with deionised distilled water into a (50ml) volumetric flask. To improve methodological reliability, samples were prepared in triplicate thus enabling the mean metal ion concentrations and their standard deviations to be calculated.

A combined standard of mercury, cadmium, lead, chromium, zinc, nickel and copper was prepared by serial dilution to a concentration of 1 mg/L. A 10-ml aliquot of each metal ion (1000 mg/L stock Merck SpectrosoL grade) was put into a volumetric flask and made to (100 ml) with distilled deionised water. A 1ml aliquot of the combined standards was then put into a volumetric flask and made to 100ml to give a 1ppm standard solution. This solution was then analysed at the required wavelength for each metal ion. The emission intensity was recorded by the ICP-AES computer system and

background corrections were made. ICP-AES (Perkin Elmer Emission Spectrometry, model plasma 40) instrument was used to determine the concentration of metal ions.

RESULTS

6.4 Heavy Metal Concentrations

The mean metal ion concentrations in the samples *H. perforatum* and *S. officinalis* collected from the different cultivation sites are presented in Tables 13 and 14. Mercury levels in all samples of *H. perforatum* and *S. officinalis* were found to be below the limits of detection. Concentrations of all other metal ions measured were detectable and found to be within the guideline limits.

Table 13. Mean metal ion concentrations (ppm) in *H. perforatum* from different locations in the UK and Europe.

Site	Hg	Cd	Pb	Cr	Zn	Ni	Cu
Leicestershire	*<LOD	0.37 † (0.05)	1.43 (0.44)	0.29 (0.15)	16.29 (2.29)	21.78 (2.88)	5.93 (0.80)
Enfield	<LOD	0.21 (0.08)	1.10 (0.29)	0.97 (0.06)	28.55 (2.62)	8.24 (1.46)	5.04 (1.18)
Spain a	<LOD	0.65 (0.13)	1.05 (0.11)	0.70 (0.33)	23.80 (1.06)	8.28 (0.39)	5.66 (0.49)
Bosnia	<LOD	0.68 (0.32)	1.23 (0.56)	0.85 (0.33)	27.45 (10.58)	8.48 (3.31)	9.09 (3.65)
Finchley	<LOD	0.29 (0.10)	1.23 (0.16)	0.50 (0.13)	18.67 (1.94)	5.71 (1.22)	4.00 (0.89)
Scilly Isles	<LOD	0.20 (0.08)	1.41 (0.66)	1.48 (0.98)	45.20 (1.13)	5.84 (0.09)	4.73 (0.29)
Dorset	<LOD	0.33 (0.02)	0.90 (0.22)	0.73 (0.09)	32.85 (2.87)	5.09 (0.04)	4.43 (0.52)
Spain b	<LOD	1.03 (0.10)	0.97 (0.36)	0.38 (0.05)	25.45 (0.57)	13.59 (1.33)	4.04 (0.49)

*LOD (Below limits of detection)

† Figures in brackets refer to the standard deviation of each sample prepared in triplicate

Table 14. Mean metal ion concentrations (ppm) in *S. officinalis* from different locations in the UK and Europe.

Site	Hg	Cd	Pb	Cr	Zn	Ni	Cu
Leicestershire	*<LOD	0.38 †(0.03)	1.48 (0.12)	1.05 (0.16)	29.67 (0.15)	13.48 (1.74)	6.79 (0.13)
Enfield	<LOD	0.07 (0.08)	1.53 (0.38)	0.80 (0.27)	32.69 (2.0)	8.09 (1.10)	4.60 (0.66)
Hungary	<LOD	0.28 (0.01)	1.43 (0.04)	0.84 (0.03)	20.71 (1.45)	16.87 (1.81)	3.59 (0.12)
Albania	<LOD	0.13 (0.06)	1.05 (0.48)	0.88 (0.30)	17.48 (4.87)	11.45 (3.41)	3.61 (1.08)
Turkey	<LOD	0.43 (0.21)	1.75 (0.31)	0.85 (0.52)	18.85 (1.51)	9.91 (0.28)	3.83 (0.23)
Finchley	<LOD	0.33 (0.09)	2.08 (0.61)	0.63 (0.21)	29.68 (1.25)	7.26 (0.77)	4.19 (0.34)
Dorset	<LOD	0.38 (0.09)	1.44 (0.43)	0.68 (0.11)	21.54 (5.58)	2.98 (0.12)	2.64 (0.17)
Kent	<LOD	0.31 (0.03)	1.66 (0.72)	0.83 (0.10)	16.34 (0.86)	4.59 (0.32)	4.26 (0.19)

*LOD (Below limits of detection)

† Figures in brackets refer to the standard deviation of each sample prepared in triplicate.

6.5 Discussion

The statutory limits for heavy metal concentrations in food items and herbs exist only for lead and cadmium. The Medicines Control Agency does not specify what are considered to be acceptable levels of contamination and interpretation of results has to be based on existing UK or European legislation and guidelines. The existing UK legislation has only set statutory limits for lead, cadmium and mercury. Mercury is potentially a serious risk to health. However, there are no UK legal limits in agricultural food items. Legal limits for mercury have been set only for seafood, which may present a contamination risk from industrial and effluent discharge. Only guideline limits are available from The Food Standards Agency (previously MAFF) for the remaining metals. Where no regulations exist in UK law for metal contamination in herbs, a general provision in the Food Safety Act (1990) attempts to control contaminants outside specific limits. This act only states that foods should be fit for human consumption, and free from harmful contaminants, but does not attempt to set limits or guidelines. The UK Food Standards Agency has set a statutory limit for lead of 1 mg/kg (1ppm) in food and a separate limit of 10.0 mg/kg in dried herbs (10ppm). Lead metal ion concentrations in this study were found to range between 0.90 and 2.08ppm and were within the limits. The highest concentrations of lead occurred in samples from the London area, Finchley and Enfield, which probably reflect air-borne pollution. These results are similar to findings from previous work, which has found lead levels to range from 0.05 to 3.0ppm (DW) in samples analysed from 1970 to 1980 (Kabata-Pendias and Pendias, 1992).

Cadmium is toxic, accumulates in the body throughout a lifetime and is subject to the general provisions of the Food Safety Act (1990). The European Commission has

proposed a draft regulation setting maximum limits for cadmium in foods that contribute significantly to dietary intakes. Whether herbs are considered significant is not clear, although the proportion of herbal products consumed is small relative to fresh plant-based products. Herbs contribute a small proportion of total metal consumed in the diet (herbal tea products have a 0.06% share of the daily amount of plant-based food eaten) (Kabelitz, 1997). The latest version of this proposal sets limits of 0.2 mg/kg (0.2ppm) for cadmium in fresh herbs (Rowles, 2000). If a concentration factor of 10 was applied for dried herbs, as was previously used for lead by MAFF, a limit of 2-ppm for cadmium would be set. The cadmium levels in this study ranged between 0.07-1.03ppm, falling within the proposed European commission limits. Plants in the UK have an average cadmium concentration ranging between 0.27-4ppm with a mean of 1ppm (Bradley, 1980) and therefore, the levels found in this study were representative of existing levels.

There are no statutory limits for zinc in food items or herbs in the UK. However, guideline limits are set at 5mg/kg in beverages and 50mg/kg in other foods (MAFF, 1998). Based on these values, the zinc concentrations were within this guideline, ranging between 16.29-45.20ppm and therefore, would meet the general safety criteria required by the MCA.

The Food Standards Committee report, cited by MAFF (1998), recommends a guideline limit of 20 mg/kg for copper in foods. Copper levels in the herbs were within this guideline limit, ranging from 2.65-9.09ppm. The copper content of plants from different countries has been previously reported to range from 1-8ppm (Tinker, 1981) and is consistent with the levels observed.

There are no UK statutory limits for chromium in food items or herbs. However, the working party on dietary supplements and health food (MAFF, 1998) considered that chromium would have undesirable effects above a chronic dose of 1-2g/kg per day. The chromium concentrations in this study were found to range between 0.29-1.48ppm and therefore meet the guideline limits. The nickel concentrations were found to range between 2.98-21.78ppm. To date, there are no statutory or guideline limits available for nickel.

Conclusion

The quality control requirement of the Medicines Control Agency for heavy metal contamination would be met, based on the results obtained, since all metals tested fell within the statutory and guideline limits where available. However, sample testing prior to use is important, even when using herbs from the same cultivation area, since atmospheric pollution and effluent contamination will always present a risk.

CHAPTER 7

HPLC ANALYSIS

7.1 Introduction

The MCA requires plant material to be correctly identified before being used in a clinical trial. This is because contamination may occur in the herbal drug either due to deliberate adulteration by a supplier or from the inclusion of plant material that has been misidentified. The consequences of a wrongly identified plant can be lethal as was the case with the *Aristolochia* species (Gottlieb, 2000). This led to a prohibition order being introduced by the Department of Health (2000) because of concerns over its safety, after patients using a slimming aid containing *Aristolochia* species developed renal failure. High Performance Liquid Chromatography (HPLC) can potentially be used to assist in confirming the identity of a plant by examining its chemical 'fingerprint' profile against reference chromatograms and phytochemical standards that are commercially available.

HPLC provides both qualitative and quantitative data and is a more versatile technique than thin layer chromatography (TLC) because it allows rapid, reproducible, high-resolution separation (Pietta *et al*, 1991), even with trace amounts of the compounds, which is why pharmacopoeias are changing from TLC to HPLC (Andrade *et al*, 1998). Other techniques such as gas chromatography (GC), capillary electrophoresis (CE) and nuclear magnetic resonance (NMR) can also be incorporated to aid and improve identification.

One of the problems of analysing herbs with HPLC is a lack of established analytical methods and standards available (Lazarowych *et al*, 1998). HPLC is mainly used for plant constituents that are non-volatile, for example, higher terpenoids, phenolics and all types of alkaloids, lipids and sugars (Harborne, 1998), making it a suitable technique for polyphenolic compounds like flavonoids (Rehwald *et al*, 1994).

The herb samples proposed for the clinical trial contain mostly phenolic derivatives and therefore HPLC is an appropriate method, given its sensitivity and suitability to the chemical constituents of the plants. The purpose of the HPLC fingerprint analysis was to examine its suitability as a method for confirming plant identity solely for an MLA-164 application to the MCA and therefore no quantitative measurements were undertaken. The established HPLC methodology used by Kew Gardens will be adopted for this project.

7.2 High Performance Liquid Chromatography spectra

High performance liquid chromatography apparatus fitted with diode-array detector displays the spectral shape of each peak. This spectral shape can assist in identifying flavonoids such as isoflavones, flavonols, and flavones. This is because each type of flavonoid has a characteristic shape and maximum absorbance (Figures 2, 3 and 4). The examination of the spectral shape is particularly valuable in phytochemistry due to the limited availability of standards. For example, isoflavones (Fig. 2) when observed at 260nm (their maximum absorbance) and 335nm (a low absorption frequency for isoflavones) have a characteristic peak shape that is distinguishable from other flavonoids, such as flavonols (Fig. 3) and flavones (Fig.4) (Greyer, 2000).

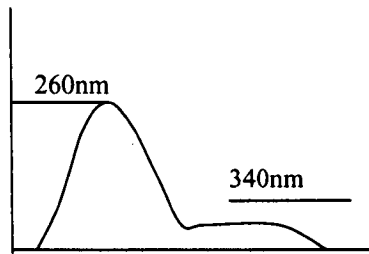

Fig 2. Peak shape of the isoflavone- genistein (Greyer, 2000).

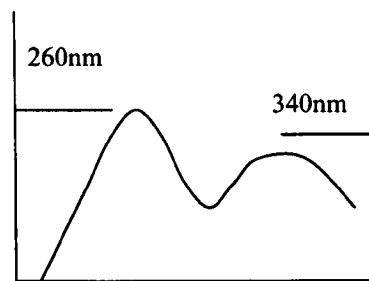

Fig 3. Peak shape of the flavonol- kaempferol (Greyer, 2000).

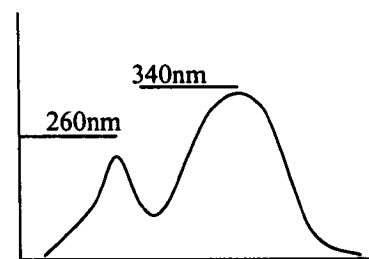

Fig 4. Peak shape of the flavone-apigenin (Greyer, 2000).

7.3 Plant Extraction

Prior to HPLC analysis, solvent extraction of the plant material is necessary. There is no single method available for extraction of phytochemicals, since this will depend on the particular constituents of interest and the type of plant material being used. The different plant extraction methods were reviewed from the literature (Table 15). It was found that the majority of flavonoid extraction methods used methanol as the solvent of choice, although ethanol was frequently used, and occasionally acetone. Methanol is a more polar solvent than ethanol and is a cheaper alternative. Reflux times varied between 15 minutes to four hours. However, this type of lengthy extraction

methodology is more suitable for quantitative analysis, because it increases the concentration of constituents due to the repetition of pure alcohol passing over the herb material, which further draws constituents from the plant sample. For qualitative 'fingerprint' analysis of the aerial parts of plants, shorter extraction times can be utilised. For example, an extraction method used by Kew Gardens is to boil the herb in methanol for 5 minutes and allow cooling for 30 minutes. This extraction method has been found to produce chromatograms that are sufficient for fingerprint analysis because the aerial parts of the plants, unlike root material, are sufficiently thin to enable penetration and extraction by the solvent (Greyer, 2000). Soxhlet apparatus is often used for the extraction of dried plant material, especially root material. Generally, if fresh plant material is used, the herb should be submerged into the solvent immediately to prevent further enzymatic oxidation from occurring.

A Soxhlet extraction method was used for the HPLC fingerprint analysis, based on the established methodology used by the National Herb Centre (Cole, 2000) which routinely performs commercial HPLC analysis. This method was chosen because it is a more exhaustive extraction process than simple infusion of plant material in hot methanol and is therefore suitable for the root material to be tested in this project.

Table 15. Existing solvent extraction methods

Herb	Constituent	Extraction Method	HPLC Solvent system
Ginkgo biloba (Pietta <i>et al</i> , 1991)	Flavonoids	Reflux 15min in 60% acetone	A= water-2propanol (95:5) B= 2propanol-THF-water (40:10:50)
Hypericum perforatum (Brolis <i>et al</i> , 1998)	Flavonoids	Hot Methanol extraction	A=water phosphoric acid (99.7:0.3) B=acetonitrile C=methanol
Hypericum perforatum (Kurth and Spreeman, 1998)	Flavonoids	Refluxed in methanol (4h)	Methanol-buffer 2.1pH-Ethyl acetate (1893:618:526)
Crataegus. Oxycanthus Rehwald <i>et al</i> , 1994)	Flavonoids	Refluxed in 80% methanol (1h)	A=Tetrahydrofuran-acetonitrile- methanol (92.4:3.4:4.2) B= orthophosphoric acid 0.5%
Lippia citriodora (Valentao, <i>et al</i> , 1999)	Flavonoids	Ethanol 40% agitated (2h)	A=water-formic acid (19:1) B=methanol
Onion (Andlauer <i>et al</i> , 1999)	Flavonoids	Methanol 80% Centrifuge (2h) at room temp.	A=acetonitrile-water-formic acid (10:90:5) B= acetonitrile-water-formic acid (90:10:5)
Trifolium pratense (He <i>et al</i> , 1996)	Flavonoids	Refluxed in 70% ethanol for (1h)	A=Water -HOAc 0.25% B= Methanol
Trifolium spp. (Klejdus <i>et al</i> , 1999)	Isoflavones	Ethanol 80% with 3Mol HCL	Acetonitrile with 0.1% TFA
Ajuga iva (Sabri <i>et al</i> , 1981).	Flavones	Refluxed in 80% methanol (1h)	Acetonitrile- water- 2% acetic acid
Alhagi pseudoalhagi (Khaitbaev, <i>et al</i> 1993)	Flavonols	Ethanol 48% (1h)	Not given
Solidago gigantea (Reznicek, <i>et al</i> , 1996)	Saponins	Methanol 80% percolation	Methanol :water (53:47) pH 5

MATERIALS AND METHODS

7.4 Materials

- Methanol Hipersolv® (analytical grade) supplied by Merck
- Acetic acid supplied by BDH
- HPLC grade water supplied by Merck
- Dried herb(s) supplied by Middlesex University herb garden, The Nation Herb centre, The Herbal Apothecary and Neal's Yard Remedies.

7.5 Method- Plant Extraction

Dry herb material was spread over an area of 300cm² and samples were taken at random. Herb material (2g) was weighed out, coarsely chopped, and added to the soxhlet thimble. 130ml of 80% analytical grade methanol was placed in the soxhlet and refluxed for one hour. The solvent extract was filtered using a Buchner flask and transferred to a rotary evaporator. The sample was evaporated, under vacuum, to dryness and reconstituted with 20ml of 99% methanol. The sample was stored at (-5°C), prior to use, and prepared for HPLC injection by filtering through a 0.45 micropore nylon disc.

7.5.1 High Performance Liquid Chromatography

The analysis was carried out using two different HPLC systems. The first system was a Kontron® HPLC with UV detector and 15cm reverse phase C-18 column. The second system consisted of a Waters® HPLC with diode array detector and 25cm reverse phase C18 column.

The HPLC programme and mobile phase used for the analysis followed the methodology used by Kew Gardens (Greyer, 2000). This method was used on both HPLC systems because it is used routinely in the pharmacognosy department at Kew for qualitative analysis and is therefore an appropriate and convenient method for this study.

The analysis was first carried out on the HPLC apparatus fitted with the UV detector.

The programme settings for the HPLC apparatus were set up as follows:

- Solvent system A: HPLC grade water with 2% acetic acid
- Solvent system B in the ratio: Methanol (18): Water (1): Acetic acid (1)
- 0 minute 75% A and 25% B
- 20 minutes 0% A and 100% B
- 24 minutes 0% A and 100% B
- 25 minutes 75% A and 25% B
- 40 minutes 75% A and 25% B
- Flow rate 1ml/min; oven temperature 30°C

The HPLC programme was then run and the spectral data was acquired over a 40-minute duration for each of the five herbal extracts. This procedure was then repeated at The Royal Botanic Gardens Kew, on a Waters® system fitted with a diode-array detector (DAD). This enabled a comparison of the two detector systems. The same extraction method and program settings were used for all the herb samples. The diode array detector enables identification of chemical groups by providing the spectral shape of each peak. This method is advantageous when chemical standards are unavailable.

7.6 Results

The results of the HPLC analysis using UV and diode array detectors are shown in Figures 5 to 14.

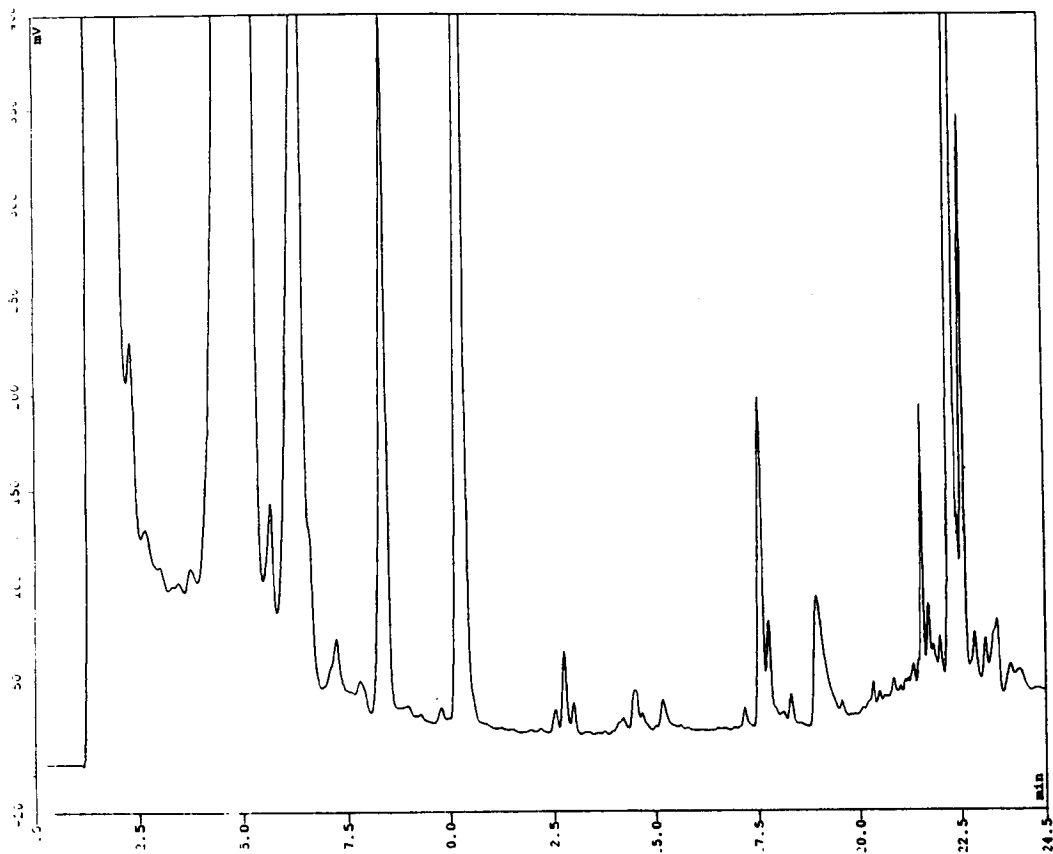

Fig. 5 Chromatogram of *Hypericum perforatum* extract acquired with a UV detector (260nm) using a 15cm C-18 reverse phase column.

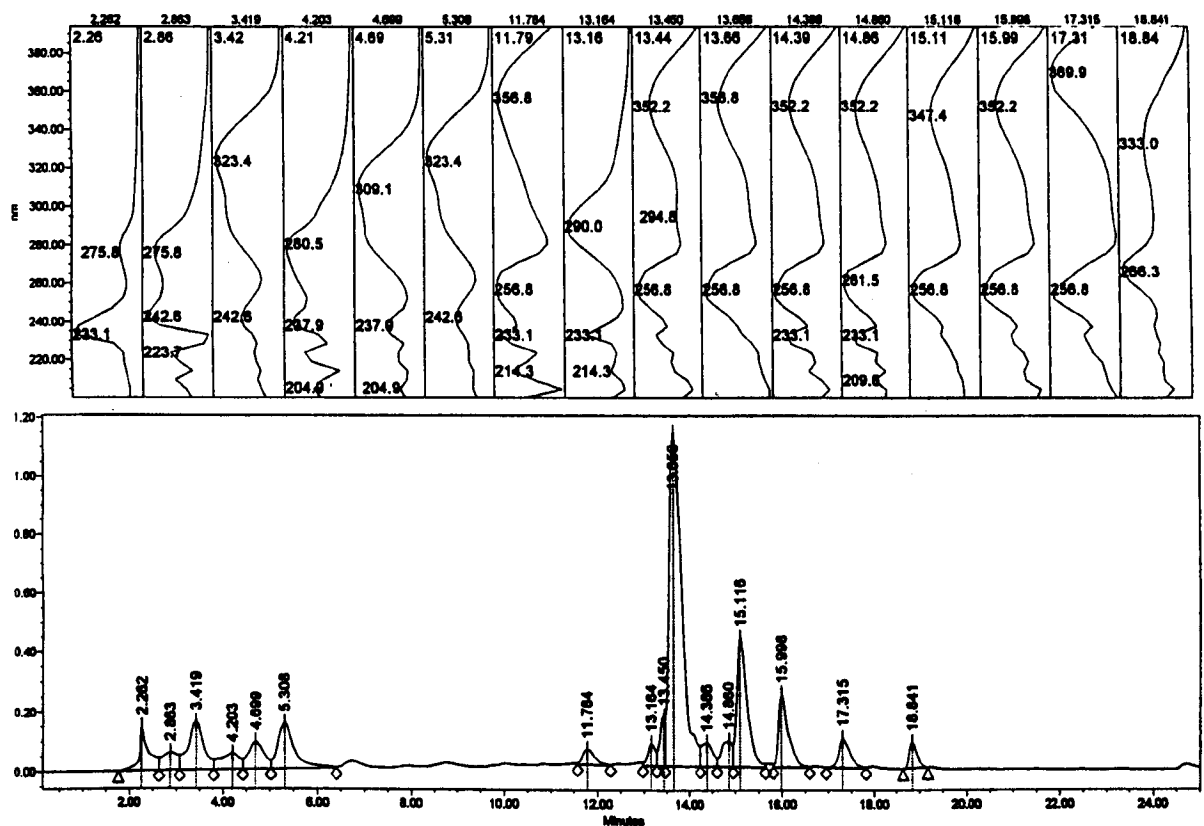

Fig. 6 Chromatogram of *Hypericum perforatum* extract acquired with a diode array detector (260nm) using a 25cm C-18 reverse phase column.

Figures 5 and 6 are the *Hypericum perforatum* chromatograms obtained from HPLC analysis using UV and diode array detectors respectively. The result of the analysis using the UV detector shows a chromatogram with approximately 16-18 peaks. The first peak is most likely to be the solvent front, given its shape and early elution. The peaks have eluted broadly into two regions across the chromatogram. The *Hypericum perforatum* chromatogram (Fig. 6) acquired with the diode-array detector (DAD) produced 16 peaks. The spectral shape of each peak is shown at the top of the chromatogram. The peaks shown in Figure 6 are clustered into two regions similar to Figure five, but are separated further apart due to a longer (25cm) column being used. The first 6 peaks in Figure 6 were acquired between approximately 2 and 6 minutes, followed by the 10 remaining peaks being acquired between 11 and 19 minutes. Peaks 9-15 cannot be identified with complete confidence. However, the peaks may be flavonols because their spectral shape and maximum absorbance are similar to the known spectral characteristic of flavonols i.e. producing maximum absorbance at approximately 260 and 340nm (Greyer, 2000; Brolis, 1998). Also, peak 8 (Fig. 6) shows a maximum absorbance at 290nm, with a slight 'shoulder' at 340nm, which is the characteristic spectrum of flavanones (Brolis, 1998). Determining the type of flavanone was not possible because the spectral information provided with DAD-HPLC did not allow further delineation because the differences between the types of flavanones were too small.

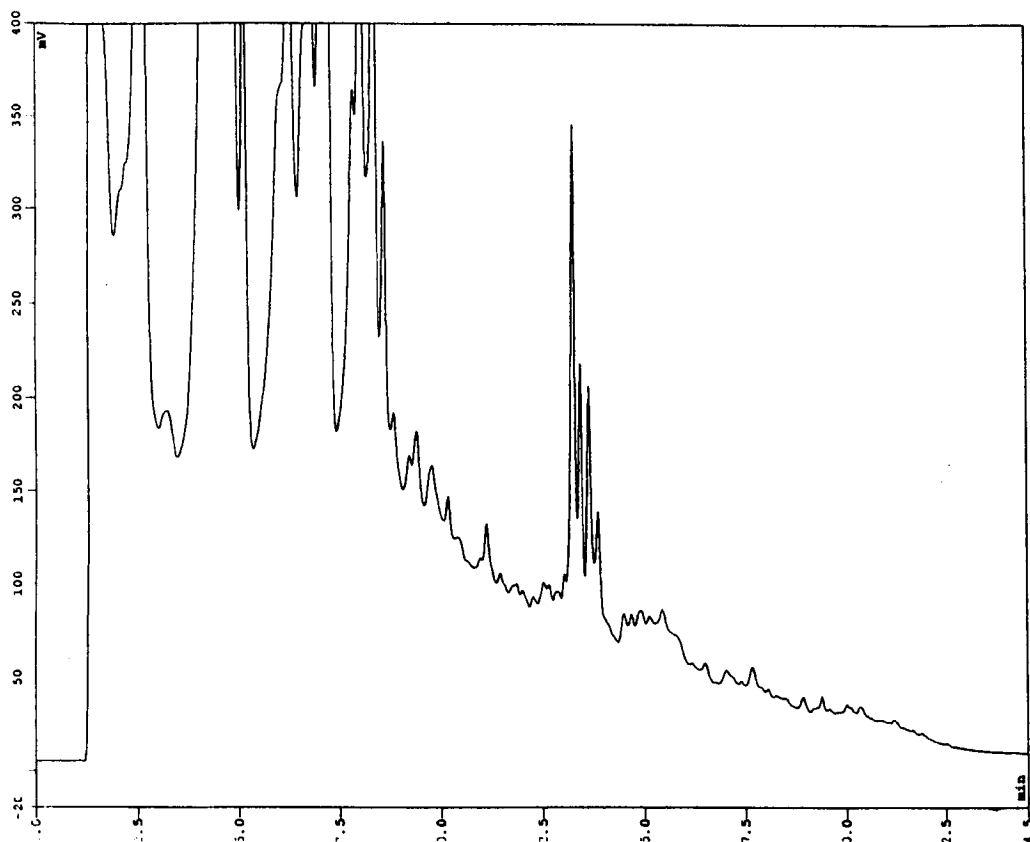

Fig. 7 Chromatogram of *Cimicifuga racemosa* extract acquired with a UV detector (260nm) using a 15cm C-18 reverse phase column.

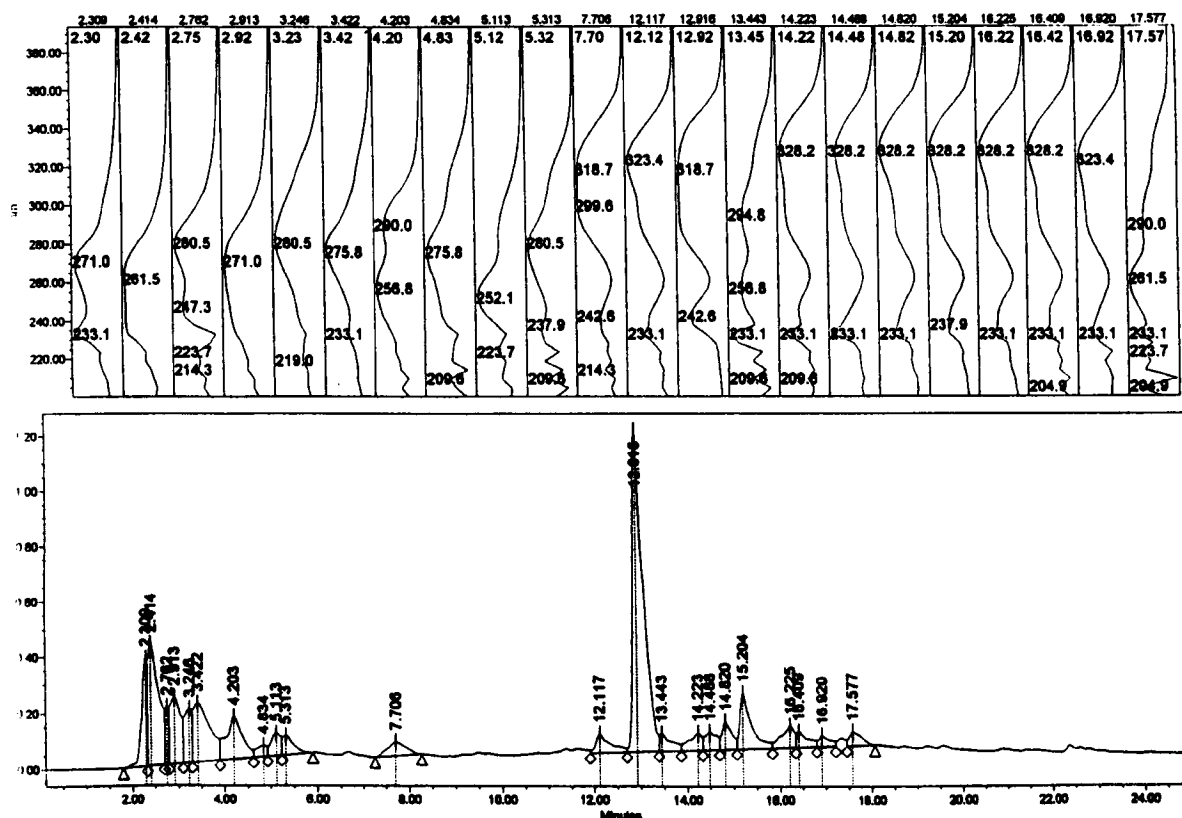

Fig. 8 Chromatogram of *Cimicifuga racemosa* extract acquired with a diode array detector (260nm) using a 25cm C-18 reverse phase column.

The *Cimicifuga racemosa* chromatograms (Fig. 7 and 8) both show peak drifting from the base line on the initial peaks that have eluted. This may be due to impurities, temperature fluctuations, electronic noise or variations in the sample composition (Pearce, 2000). The peaks appearing between 0 and 15 minutes have not completely separated. In contrast, the *Cimicifuga racemosa* chromatogram in Figure 8 has superior peak separation due to a longer column used. In Figure 7, there are 6 peaks appearing very closely together between 2 and 3.5 minutes. These constituents share a similar retention time and a longer column would have further enhanced peak separation.

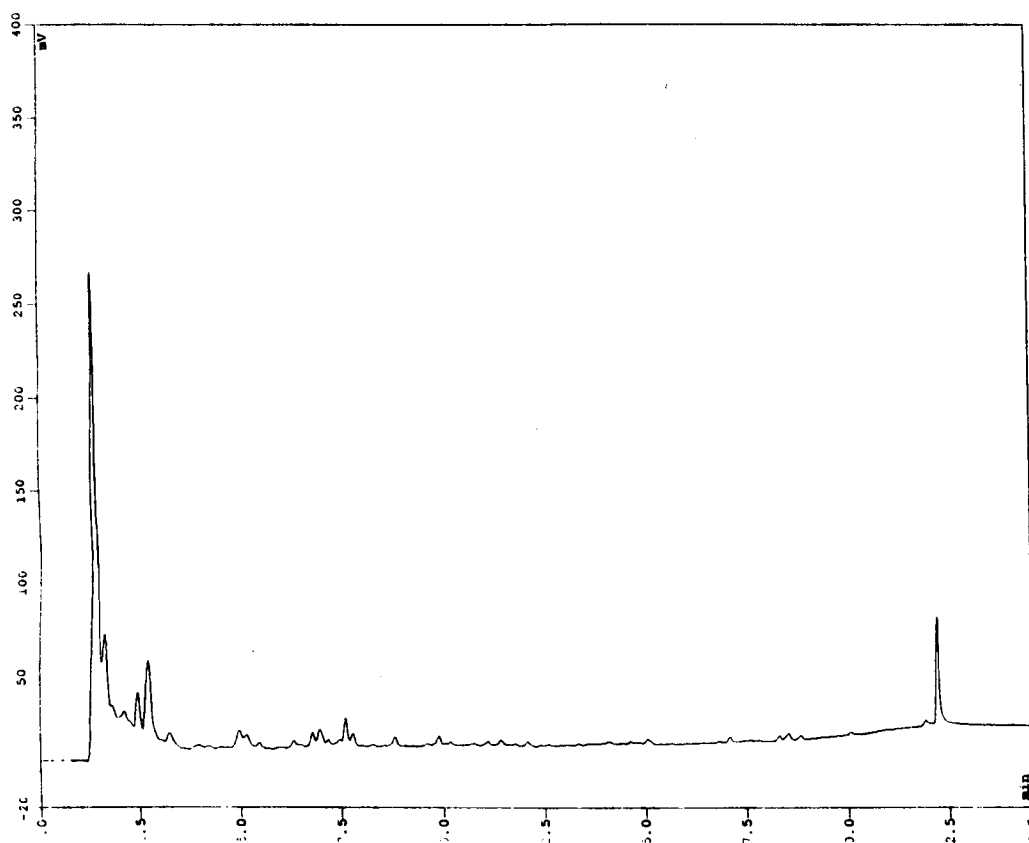

Fig. 9 Chromatogram of *Dioscorea villosa* extract acquired with a UV detector (260nm) using a 15cm C-18 reverse phase column.

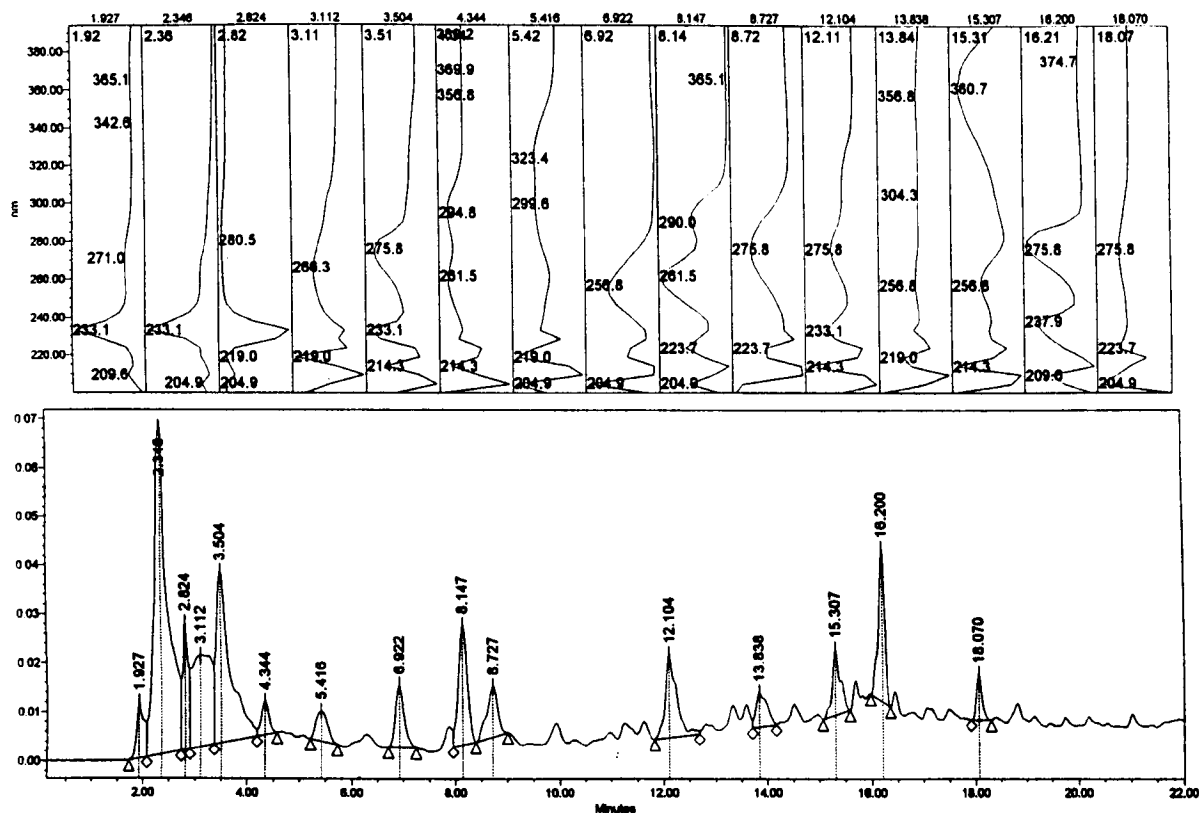

Fig. 10 Chromatogram of *Dioscorea villosa* extract acquired with a diode array detector (260nm) using a 25cm C-18 reverse phase column.

The *Dioscorea villosa* chromatogram acquired with the UV system (Fig. 9) has produced approximately 6 peaks, but the peak height is low, indicating possible poor sample resolution. In contrast, the DAD derived chromatogram (Fig. 10) has acquired 15 peaks with greater height. One possible explanation for the increased number of peaks and their greater height is that the HPLC system with DAD has greater sensitivity.

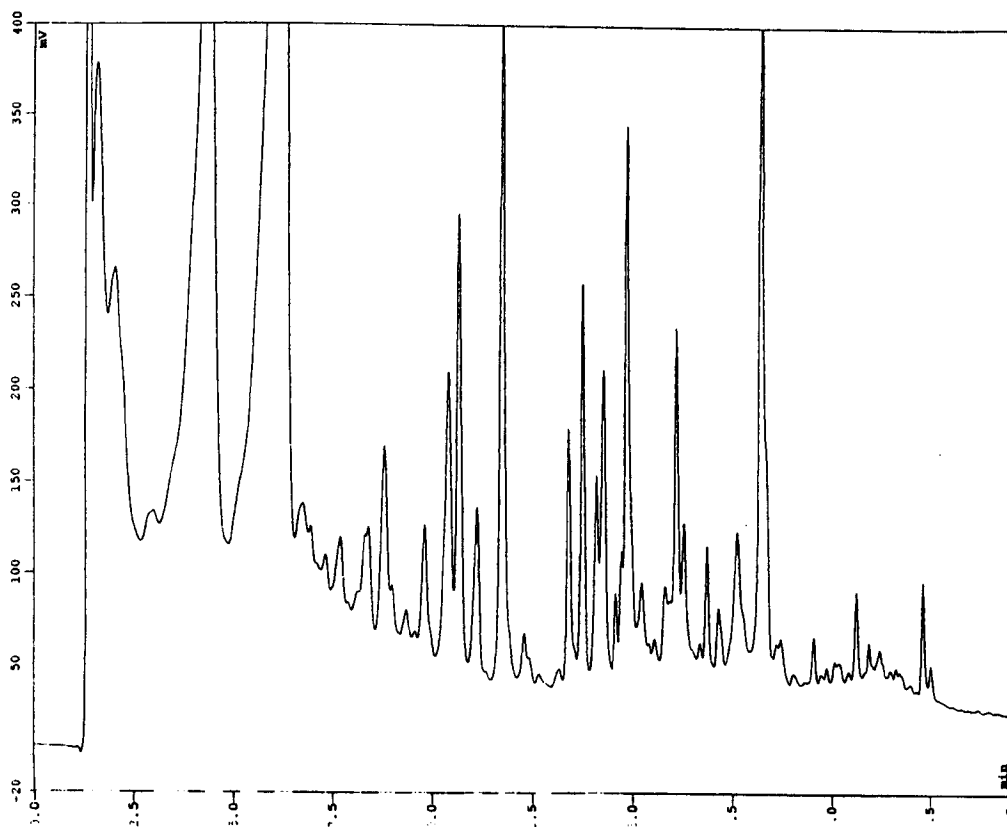

Fig. 11 Chromatogram of *Salvia officinalis* extract acquired with a UV detector (260nm) using a 15cm C-18 reverse phase column.

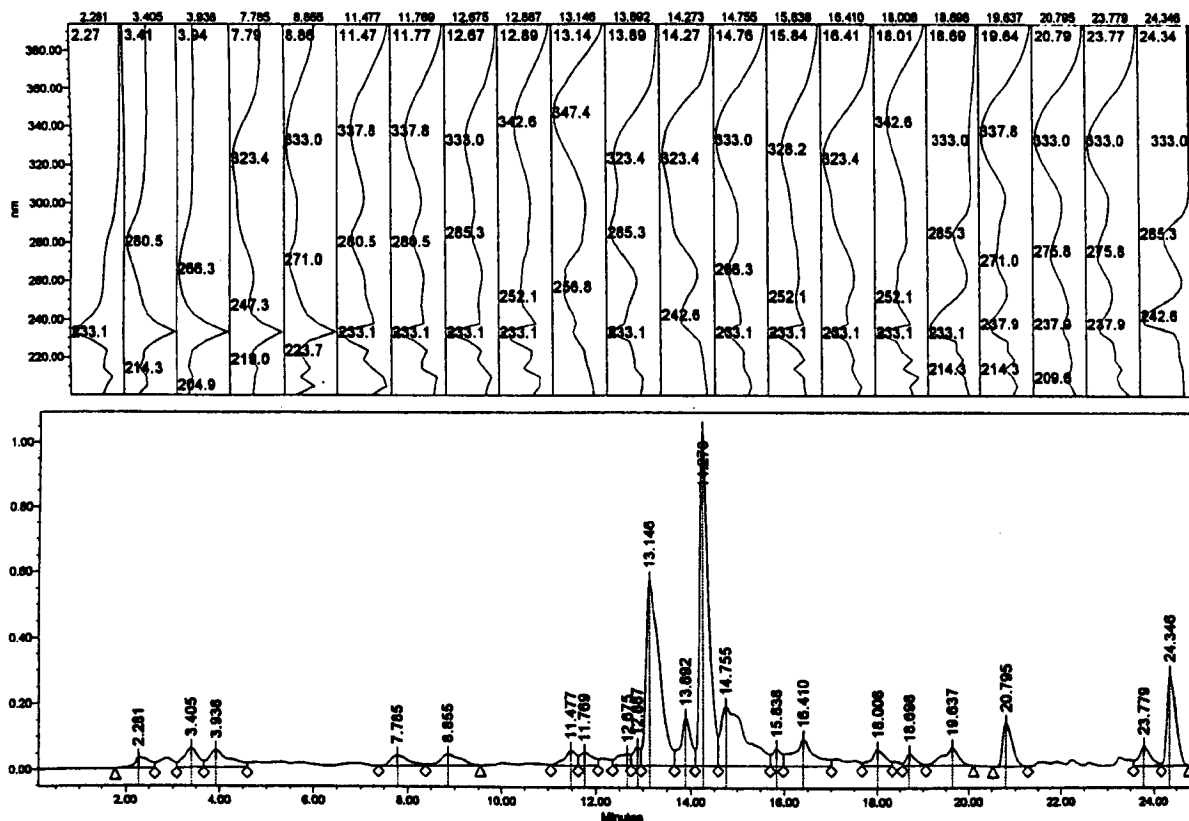

Fig. 12 Chromatogram of *Salvia officinalis* extract acquired with a diode array detector (260nm) using a 25cm C-18 reverse phase column.

The *Salvia officinalis* chromatogram acquired on the UV system (Fig. 11) shows good peak separation and acquired approximately 27 peaks. There is considerable peak drift occurring from the base line. In contrast, the DAD derived chromatogram (Fig. 12) has acquired only 21 peaks. This may be due to degradation of the extract. Peaks 10 and 13 in Figure 12 may be flavones because the spectral shape of both peaks is similar to the typical spectral shape of a flavone having its maximum absorbance at 260 and 340nm (Greyer, 2000).

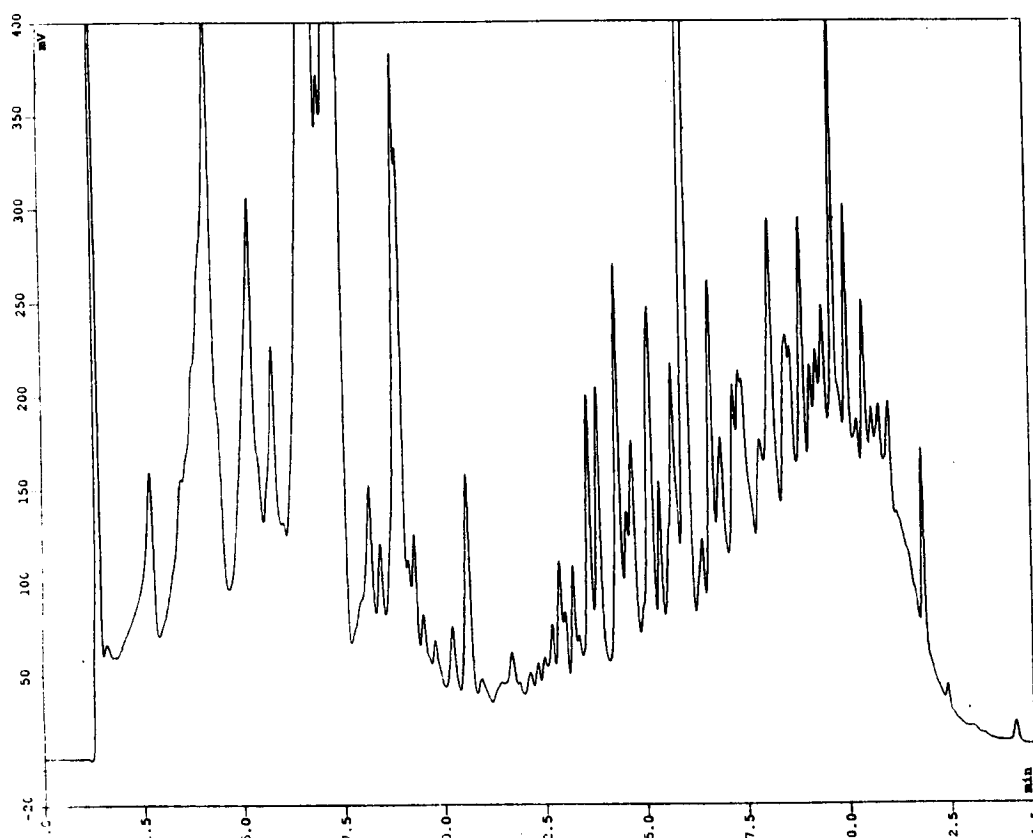

Fig. 13 Chromatogram of *Glycyrrhiza glabra* extract acquired with a UV detector (260nm) using a 15cm C-18 reverse phase column.

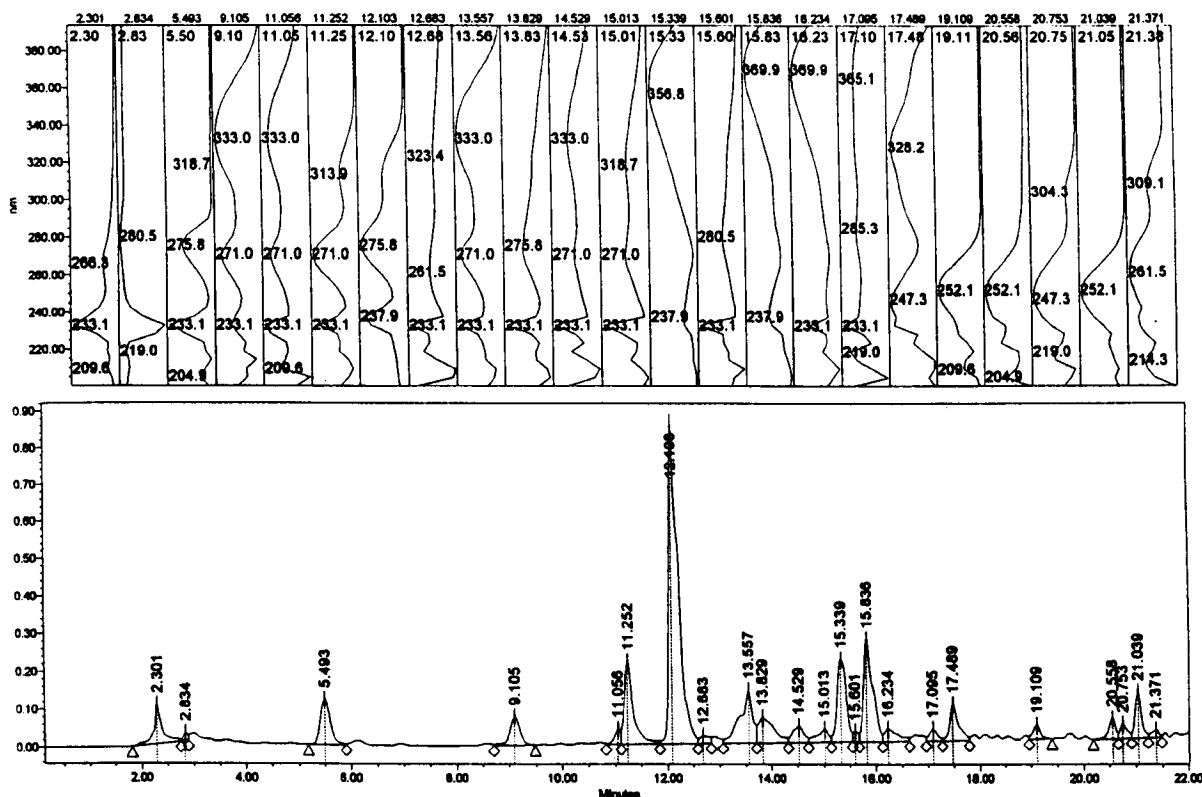

Fig. 14 Chromatogram of *Glycyrrhiza glabra* extract acquired with a diode array detector (260nm) using a 25cm C-18 reverse phase column.

The *Glycyrrhiza glabra* chromatogram acquired on the UV system (Fig. 13) acquired approximately 48 peaks. The peaks are not in all cases fully separated and have begun to ‘split’ during elution. The splitting may have been caused by pH mismatch or contamination (Pearce, 2000). Drift has also occurred during peak elution. The DAD derived chromatogram (Fig. 14) has in contrast acquired only 23 peaks, which may be due to extract degradation or differences between HPLC apparatuses. Peaks 19 and 20 (Fig. 14) may be isoflavones, (see Figure 2) showing the same spectral shape with maximum absorbance at 260nm with a slight ‘shoulder’ at 340nm (Greyer, 2000).

7.7 Discussion

High Performance Liquid Chromatography ‘fingerprint’ analysis using diode array detection is a superior method for identifying plant groups compared to simple UV detection because it can aid identification of individual peaks. However, identifying the type of isoflavone, flavanone or flavone was not possible because their characteristics are too similar. ‘Finger print’ analysis is also a convenient method of analysing changes in the extracts, which can be re-run using the original program. However, the two chromatograms produced on different HPLC systems for each plant extract showed considerable variation in the number of peaks eluted and the overall ‘fingerprint’ profile. This variability has also been observed in the chromatographic profile of *Hypericum perforatum* and *Cimicifuga racemosa* (Brolis, 1998; Sloley, 2000; Institute for Nutraceutical Advancement, 2000). Furthermore, Lazarowych and Pekos (1998) also reported similar inconsistencies in the chromatographic ‘fingerprint’ of different samples of *Tanacetum parthenium* and consistent ‘fingerprints’ were only achieved using plants grown from the same seed bank. These variations can partly be explained by the differences with the different systems used such as the detector, columns, packing material and inconsistencies in the flow rate and temperature. The chemical profile of the same plant species can also vary significantly due to factors such as the variations in soil conditions, growing locations and the time of harvest. These natural variations make fingerprint analysis difficult, particularly as a method to confirm the plant identity against a reference ‘fingerprint’ chromatogram.

Due to the variability in the chromatographic profile of plants and the lack of phytochemical standards available to identify individual constituents, HPLC fingerprint analysis is not an adequate method of establishing a plants authenticity on

its own for the purpose of satisfying the requirements of the MCA. It would be preferable to use a botanist who would be able to issue a voucher specimen number, to confirm plant authenticity. However, HPLC could be used alongside other techniques such as gas chromatography, thin layer chromatography, bioactivity fractionating assays and nuclear magnetic resonance imaging to add supporting evidence if required.

CHAPTER 8

DISCUSSION AND CONCLUSIONS

8.1 The Menopause and Hormone Replacement Therapy

The menopausal transition for some women will include the development of hot flushes and other hormonally related symptoms. A further consequence of the menopause may be the development of osteoporosis, which can lead to infirmity or mortality. HRT is one form of treatment that provides relief for some women. However, it is not an option for all women due to side-effects, contraindication and the personal preferences of some women, and therefore other forms of treatment need to be developed.

8.2 Research Funding for Herbal Medicine

Herbal medicines have been shown to be effective for a variety of health problems, including the menopause. The research funding for herbal medicine is presently less than 1% of the total research expenditure in health care in the United Kingdom. The dilemma for herbal medicine research is that funding is unlikely to be made available by private companies since the costs of conducting clinical trials are considerable, especially if data is required to demonstrate the pharmacological, and toxicological properties. These costs are unlikely to be recouped because plants cannot be easily patented. Therefore, the potential for a financial return on any investment is tenuous and as a consequence the inclusion of (CAM) into the NHS based on clinical evidence will be hindered by the limited research output. However, the potential benefits of herbal medicine may include: the effective treatments of many acute and chronic conditions, avoidance of iatrogenic illness, minimal side-effects in contrast to

pharmaceutical drugs and financial savings for the NHS. A two- tier situation exists for complementary medicine, since only those who can or are willing to pay privately are able to access it. Maintaining an orthodox health care system that excludes other medical philosophies will limit patient access to other forms of treatment and may stifle medical progress.

8.3 Research Methodology for Herbal Medicine

The probability of producing positive research findings becomes more difficult when the 'gold standard' of a double-blind, placebo controlled trial is used because of the increased requirements for narrow objective evidence. Furthermore, this methodology does not reflect the practice of herbal medicine. Patients with the same biomedically defined illness may be treated differently, as the basis of treatment is formed from the clinical manifestations of the condition rather than the diagnostic label. 'Pigeon-holing' patients into receiving standard medication may reduce the potential of finding a positive result, whilst a negative outcome may be a reflection on the study design rather than the treatment.

8.4 The limitation of the MLA-164 application process

To conduct a clinical trial, permission has to be obtained from the MCA, which is granted once the criteria for safety have been met. The MCA's requirements for the applicant to demonstrate the stability of herbal remedies in accordance with the International Conference on Harmonisation degradation limits of $\pm 10\%$ (ICH, 1996) are not achievable for herbal remedies, since constituent degradation levels in excess of 10% appear to be the norm rather than the exception. However, it is unlikely that the efficacy of medicinal herbs will be diminished to a degree where no therapeutic

value remains, based on the observations of clinicians. The validity of the ICH limits for herbal remedies is questionable, since they were not developed using a therapeutic index for medicinal herbs against constituent degradation. The MCA's requirements within the MLA-164 document for batch analysis on the herbs are also unworkable since the chemical profile will inevitably vary between different batches used. The chemical constituents in herbs are affected by different times of harvest, soil conditions and weather patterns. Different varieties of the same species can show wide variances in constituent concentrations. The ICH stability limits were originally devised for pharmaceutical drugs.

A system of transferring the safety stipulations of pharmaceutical drugs to herbal remedies is inappropriate. Herbal remedies appear to have a long established history of safe use, unlike pharmaceutical drugs where side-effects and contraindications are the norm rather than the exception, as shown in the British National Formulary (2001). Furthermore, herbal medicines are not new drugs entering the market for the first time since they have so called 'established use' status. Given that herbal remedies do not easily fit into pharmaceutical legislation, separate legislation would be welcome to specifically control traditional medicines.

The conundrum between the theory and practice of an MLA-164 application is a concern that has been raised by representatives of health food manufacturer associations. These concerns were addressed in a speech given to the Health Food Manufactures Association in November 2001 by MCA representatives for herbal policy who stated:

“They (the applicants) [sic] may read the relevant guidance and recognise that for a particular herbal remedy it would be difficult or impossible to assay constituents or to demonstrate stability in a meaningful way.”

“It is typical for applicants to persuade the MCA that it can be justified not to provide detailed data on impurities or degradation products. Indeed we are well aware that for many herbal ingredients the constituents responsible for their effects are simply not known.”

Unfortunately, persuading the MCA that stability testing should be omitted for constituent levels and degradation products is not as easily achieved as the above statement implies. The outcome from previous discussions with the MCA was that stability testing would have to be performed. However, it was suggested that some leeway might be given with the ICH specification limits.

8.5 Bibliographic Information to Support an Application

Satisfying the MCA’s requirements within the MLA-164 document to provide experimental and biological data on the herbs, through bibliographical supporting evidence, was difficult due to the limited research available. *Hypericum perforatum*, *Cimicifuga racemosa* and *Glycyrrhiza glabra* had good supporting evidence for efficacy and safety in human subjects, but there was minimal research for *Salvia officinalis* and none for *Dioscorea villosa*. There was no mutagenic or carcinogenic research available in the literature for the herbs. As the treatment was designed for menopausal women it was unlikely that the MCA would require mutagenic testing to be performed. However, from previous meetings with the MCA, it was not established

if carcinogenic testing would need to be performed before a licence could be granted as the MCA's representatives gave differing opinions. The MCA are prepared in theory to accept bibliographical evidence for the safety and efficacy of herbal medicines. However, once herbs are combined within a formula the supporting bibliographical information may be considered irrelevant by the MCA because of the perceived risks of herbal interactions occurring. The MCA may then insist on toxicological studies being performed.

8.6 Quality Control Procedures

The procedures necessary to obtain a clinical trial certificate from the MCA are complex, and involve considerable developmental work to satisfy the safety requirements. Identification tests and quality control procedures based on specifications stated in British and European Pharmacopoeias, and herbal pharmacopoeias need to be conducted by a UCAS accredited public analyst, since in-house quality control is unlikely to be acceptable, given the need for independent evaluation. However, with increasing safety requirements being demanded of the applicant, authenticity tests conducted by a UCAS accredited laboratory may not necessarily be sufficient. Confirmation may have to be obtained through a botanist who is able to issue a voucher number to confirm identity. Microbiological testing is an important procedure to ensure the patient's safety, especially as powdered herbs may not be able to meet the microbiological specification limits for bacteria as demonstrated by Czech *et al* (2001). Alternative formulations and processing may be required in order to meet the safety criteria such as sterilising tablets by autoclave to control microbiological contamination.

8.7 The Production of Medicinal Herbs

A problem for herbal medicine research is the sourcing of a supplier who is able to provide a complete documentary history of the plants. Producers of organically certified herbs in Europe, have to maintain records of the life-cycle of the herbs including the origin of the seeds or cuttings, place of cultivation, and harvesting and storage methods, similar to those governed in the United Kingdom by the Soil Association. However, none of the major companies contacted in the United Kingdom were able to provide documentation, from their suppliers, to the standards stipulated by the Soil Association. This was due to growers from Europe and the United States not having such records available. Therefore, herbs may need to be grown specifically for a clinical trial to ensure the necessary documentation is available.

8.8 Experimental Results

The quality control requirement of the Medicines Control Agency for heavy metal contamination would be met, based on the results obtained, since all metals tested fell within specified limits. However, sample testing prior to use is important, even when using herbs from the same cultivation area, since atmospheric pollution and effluent contamination will always present a risk.

The results of the HPLC analysis showed that performing fingerprint analysis as an aid to confirming plant authenticity is not an appropriate method given the variations found in the results and comparisons with published works. This situation may change once the number of phytochemical standards increases to assist with plant analysis. However, using a botanist to confirm plant identity, through the issue of a voucher number, is a method that would be accepted by the MCA. HPLC fingerprint analysis

may be of value for quality control purposes, such as stability studies by monitoring changes in the peak area of a plant.

8.9 Conclusions

There is a scarcity of published information detailing the specifications and procedures necessary to prepare herbal medicine based applications to the MCA. Furthermore, the MLA-164 is, in parts, both ambiguous and unworkable in relation to herbal medicines. This work has highlighted these issues and furthered the knowledge of conducting double-blind, randomised, placebo controlled trials specifically for herbal medicines. The research has brought to the fore important issues that future researchers will encounter. In particular, a greater understanding has been achieved of the application process through the completion of a Medicines Control Agency MLA-164 dossier.

The main dilemma for herbal medicine research is developing the herbal drug intervention since this will be the main focus for scrutiny. The development of an herbal formula presents unique problems because of their complex pharmacology and largely unknown chemistry. Developing the herbal formula for this study has elucidated several important issues which herbal medicine based research applications will encounter, and advanced the knowledge in this poorly understood area. In particular, it was demonstrated how a herbal medicine formula is developed based on traditional usage and the type of quality control procedures that need to be implemented. However, it became clear whilst completing the MLA-164 application that the level of bibliographic information available to support an application was insufficient to address all of the MCA's requirements for pharmaceutical data and some aspects of quality control were unachievable. In addition, it emerged during

meetings with the MCA that it was their view that herbal medicines might be viewed as unknown entities when combined into a formula and thus invalidating bibliographic safety data on individual plants.

One conclusion that can be drawn from the work completed is that applications to the MCA for clinical research trials into the efficacy of herbal medicine would be assisted by the provision of evidence collected by conducting an initial pilot study (via an *MLA-162* application) incorporating a toxicological study. Toxicological data gathered through liver and kidney function tests could be used to demonstrate the safety of a formula and thus support a larger *MLA-164* based study.

Developing a well designed research protocol and operations manual is essential to enable a study to achieve its aims within an ethical framework. The merits of a well designed double-blind, randomised controlled trial cannot be overstated since the generalisation of the results will be related to the quality of the trial. Nevertheless, this methodology does not reflect the way in which herbal medicine is actually practised and the potential benefits of this therapeutic discipline may become submerged within a standardised controlled trial. Future work would need to address this issue. The research protocol for this work was successfully submitted to the university ethics committee, and the operations manual was developed to ensure the study would be systematically implemented. These two documents were developed specifically for this study and provide the 'blueprint' for the running of the clinical trial.

In addition to furthering the knowledge of research applications for herbal medicines, the thesis has also completed much of the preliminary work necessary to submit an

MLA-164 application to the MCA. The work could be used as the basis for implementing a clinical trial to evaluate the benefits of herbal medicine in menopausal symptoms.

References

- Adams, R. (1999). Personal communication. London: Middlesex University.
- Alder, E. (1998). 'The Blatt Kupperman Index: a critique'. Maturitas. 29, p19-24.
- Aloia, J.F. (1996). 'Bone density measurements in menopausal women using HRT'. Osteoporosis Int. 6, p55-62.
- Altman, D.G. (1980). 'Statistics and ethics in medical research'. BMJ. 15th November. 281, p1336-38.
- Anderson, J.J. (1999). 'Plant based diets and bone health: nutritional implication'. Am. J. Clin. Nutr. 70, p539-42.
- Andlauer, W., Martena, M.J., Furst, P. (1999). 'Determination of selected phytochemicals by reversed phase-high-performance chromatography combined with ultraviolet mass spectrometric detection'. J. of Chromatography. 849, p431-48.
- Andrade, P.B., Seabra, R.M., Valentao, P., Areias, F. (1998). 'Simultaneous determination of flavonoids, phenolic acids, and coumarins in seven medicinal species by HPLC/diode-array detector'. J. Liq. Chrom. and Technol. 21 (18), p2813-20.
- Bachmann, G.A. (1999). 'Vasomotor flushes in postmenopausal women'. Am. J. Obstet. Gynecol. 180, p312-16.
- Barlow, D.H. (1992). 'HRT and other menopause associated conditions'. British Medical Bulletin. 48 (2), p356-67.
- Barrett, J. (1996). 'Phytoestrogens: friends or foes?' Environ. Health Perspectives. 104, p478-82.
- Bayly, G.R., Braithwaite, R.A., Sheehan, T.M.T., Dyer, N.H, Grimley, C., Ferner, R.E. (1995). 'Lead poisoning from Asian traditional remedies in the West Midlands - report of a series of five cases'. Human & experimental toxicology. 14, p24-8.
- Bensky, D., & Gamble, R. (1992). Formulas and Strategies. Seattle: Eastlands Press.
- Bensky, D., & Gamble, R. (1992). Materia medica. Seattle: Eastlands Press.
- Bernardi, M., Dintino, P.E., Trevisani, F., Cantelliforti, G., Raggi, M.A., Turchetto, E., Gasbarrini, G. (1994). 'Effects of prolonged ingestion of graded doses of licorice by healthy volunteers'. Life Sciences. 55, (11), p863-872.
- Bilia, A.R. & Bergonzi, M.C. (2001). 'Evaluation of the chemical stability of St. John's wort commercial extract and some preparations'. Int. J. of Pharmaceutics. 212, (1), p199-208.

Boblitz, N., Schrader, H.H., Zepelin, H.V., Wustenburg, P. (2000). 'Benefits of a fixed drug combination containing St. John's wort and black cohosh for climacteric patients- results of a randomised clinical trial'. Focus on Alternative and Complementary Medicine. 5, (1), p85.

Bone, K., & Mills, S. (2000). Principle and Practice of Phytotherapy. London: Churchill Livingstone, p46.

Bradley, R.I. (1980). 'Trace elements in ground soil, Llechryd, Wales' Geoderma. 24, p17.

British Herbal Pharmacopoeia. (1983). Bournemouth: British Herbal Medicines Associations.

British Herbal Pharmacopoeia. (1990). Bournemouth: British Herbal Medicines Associations.

British National Formulary. (2001): No.42, September, London: BMA & Royal Pharmaceutical Society of GB.

Brolis, M., Gabetta, B., Fuzzati, N., Pace R., Panzeri, F., Peterlongo F. (1998). 'Identification by high performance liquid Chromatography'. Journal of Chromatography A 825, p9-16.

Brzezinski, A. & Debi, A. (1999). 'Phytoestrogens: the natural selective estrogen receptor modulators?' Eur. J. Obstet. Gynecol. Reprod. Biol. 85, p47-51.

Burger, H.G. (1994). 'Diagnostic role of follicle-stimulating hormone (FSH) measurement during the menopausal transition analysis of FSH, oestradiol and inhibin'. Eu. J. Endocrinol. 130, p38-42.

Burger, H.G. and Teede, H. (1999). 'Treatment of menopausal women'. in: A Rogerio (ed.). Basics and clinical aspects (2nd. ed.). Philadelphia: Lippincott Williams and Wilkins, p61.

Campbell, S., & Monga, A. (2000). Gynaecology by ten teachers. (17th ed.). New York: Oxford University Press, p225-28.

Chauhan, S.K., & Agrawal. (1999). 'Stability studies of herbal drugs'. The Eastern Pharmacist. June, p35-36.

Cole, R. (2000). Personal Communication. Oxford. The National Herb Centre.

Cramer, D.W., Harlow, B., Xu, H. (1995). 'Cross sectional and case controlled analyses of the association between smoking and early menopause'. Maturitas. 22, p79-87.

Culbreth, D.M.R. (1927). A manual of Materia medica and Pharmacology. (7th ed.). Philadelphia: Lea and Febriger, p157.

- Czech, E., Kneifek, W., Brigitte, K. (2001). 'Microbiological Status of Commercially Available Medicinal Herbal Drugs- A Screening Study'. Planta Medica. 67, p263-269.
- De Aloysio, D., Gambacciani, M., Meschia, M. (1999). 'The effect of menopause on blood lipid and lipoprotein levels'. Atherosclerosis. 147, p147-153.
- De Leo, V. (1998). 'Trattamento dei disturbi neurovegetativi della donna in menopausa con un preparato fitoterapico'. Minerva Ginecol. 50, p207-11.
- Dolan P. (1998). 'The cost of treating osteoporosis fractures in the United Kingdom female population'. Osteoporosis International. 8, p611-617.
- Empson, J.A. (1999). 'Effects of sex steroids on sleep'. Ann. Med. 31, p41-45.
- Ernst, E., Pittler, M.H., Stevenson, C. (2001). 'Phytomedicines in the United Kingdom'. 1 (1), p13-19.
- ES COP. (1997). Monographs. United Kingdom: Exeter.
- European Pharmacopoeia. (2001). (4th ed.). Strasbourg: Council of Europe.
- Fitzpatrick, R., Ziebland, S., Jenkinson, C., Mowat, A. (1992). 'Importance of sensitivity to change as a criterion for selecting health status measures'. Qual. Health Care. 1, p89-93.
- Fletcher, A., Gore, S., Jones, D., Fitzpartick, R., Spiegelhalter, D., Cox, D. (1992). 'Quality of life measures in health care. II: Design, analysis, and interpretation'. BMJ. 305, 7, (7th November), p1145-48.
- Food Safety Act. (1990). London: Food Standards Agency.
- Foster, S. (2000). Black cohosh. Available from: <http://www.herbphoto.com/education/monograph/bkcohosh.html>
- Freidman, L.M., Furberg, C.D., DeMets D.L. (1996). Fundamentals of clinical trials. London: Mosby.
- Fulder, S. (1988). Ginseng. London: Thorsons.
- Gambacciani, M., Spinetti, A., De Simone, L., Cappagli, B., Taponeco, F., Ciaponi, M., Piaggese, L., Gallo, R., Facchini, V. (1995). 'Postmenopausal bone loss of the proximal femur: estimated contribution of menopause and ageing'. Menopause. 2, p169-74.
- Glenville, M. (1997). Natural alternatives to HRT. London: Kyle Cathie Ltd.
- Gottlieb, S. (2000). 'Chinese herb may cause cancer'. BMJ (17 June). 320, p623.

- Gow, S.M., Turner, E.I., Glassier, A. (1994). 'The clinical biochemistry of the menopause and hormone replacement therapy'. Ann. Clin. Biochem. 31, p509-528.
- Greendale, G. (1997). 'Management of the menopause with HRT'. Endocrin. Metab. Clin. North Am. 79, p261-77.
- Greene, J.G. (1998). 'Constructing a standard climacteric scale'. Maturitas. 29, p25-31.
- Greene, J.G. (1999). 'Methods of assessing climacteric symptoms'. J. of Brit. Meno. Soc. December, p173-76.
- Greyer, R. (2000). Personal communication. The Royal Botanic Gardens Kew: London.
- Harbourne J. (1998). Phytochemical Methods: a guide to modern techniques of plant analysis. (3rd. ed), Chapman and Hall: London, p15.
- Hardy, R. & Kuh, D. (1999). 'Reproductive characteristics and the age at inception of the perimenopause in a British National Cohort'. Am. J. Epidemiology. 149, p612-20.
- He, X.G., Lin, L.Z., Lian, L.Z. (1996). 'Analysis of flavonoids from red clover by liquid chromatography-electrospray mass spectrometry'. J. of Chromatography A. 755, p127-32.
- Hilditch, J.R., Lewis, J., Peter, A., Van Maris, B., Ross, A., Franssen, E., Guyatt, G.H., Norton, P.G., Dunn, E. (1996). 'A menopause-specific quality of life questionnaire: development and psychometric properties'. Maturitas. 24, p161-75.
- House of Lords. (2000). Session 1999-2000, 6th Report. Select Committee on Science and Technology: 'Complementary and Alternative Medicine'. London: The Stationary Office.
- Hunter, M.S. (1991). 'The Women's Health Questionnaire: A measure of mid-aged women's perceptions of their emotional and physical health'. Psychology and Health. 7, p45-54.
- Hunter, M.S. (1994). 'Intentions to use HRT in a community sample of 45-year old women'. Maturitas. 20, p13-23.
- Hunter, M.S. (1995). 'A psychological analysis of menopausal hot flushes'. British Journal of Clinical Psychology. 34, p589-99.
- ICH. (1996). International Conference on Harmonisation of Technical Requirements for Photostability of Medicinal Products Intended for Human Use. December 96, issued as CPMP/ICH/279/95. Geneva, Switzerland.
- Institute for Nutraceutical Advancement. (2001). Available from: <http://www.nutraceuticalinstitute.com/>.

- Introsa, N.C., Marzola, M.P., Bonnefont, A.B. (1998). 'Cellular and molecular basis of oestrogen's neuroprotection: potential relevance for Alzheimer's disease'. Mol. Neurobiol. 17, p73-86.
- Johne, A., Brockmuller, J., Bauer, S., Maurer, A., Langheinrich, M., Roots, I. (1999). 'Pharmokinetic interaction of digoxin with an herbal extract from St John's wort'. Clin. Pharmacol. Ther. 66, p338-45.
- Kabata-Pendias, & Pendias H. (1992). Trace elements in soils and plants (2nd ed) London :CRC press.
- Kabelitz, L. (1997). 'Heavy Metals in Herbal Drugs'. The European Journal of Herbal Medicine. 4 (1), p25-9.
- Kato, I., Toniolo, P. (1998). 'Prospective study of factors influencing the onset of natural menopause'. J. Clin. Epidemiology. 51, p1271-1276.
- Kaufert, P.L. (1986). 'The menopausal transition: the use of oestrogen'. Can. J. Publ. Health. 77, (S1), p85-91.
- Kim, H.L. (1999). 'St John's wort for depression: a meta analysis of well-defined clinical trials'. J. Nerv. Ment. Dis. 187, (9), p532-8.
- Khaitbaev, KH., Sultan, A., Ganiev, S., Aslanov, A. (1993). 'Qualitative determination of the total flavanols in Alhagi pseudoalhagi'. Chemistry of Natural Compounds 29, (5), p586-89.
- Klejdus, B., Vitamvasova, D., Kuban, V. (1999). 'Reversed-phase high-performance liquid chromatographic determination of isoflavones in plant material after isolation by solid phase extraction'. J. of Chromatography. A. 839, p261-263.
- Knight, D & Eden, JA. (1996). A review of the clinical effects of phytoestrogens. Obstst Gynecol 87, p897-904.
- Kos, V., Budic, B., Hudnik, V., Lobnik, F., Zupan, M. (1996). 'Determination of heavy metal concentrations in plants exposed to different degree of pollution using ICP-AES'. Fresenius J. Anal. Chem. 354, p648-52.
- Kurth, H & Spreeman R. (1998). 'Phytochemical characterisation of various St. John's Wort Extracts'. Advances in Phytotherapy 15 (2), p117-129.
- Leigh, P & Fries, J. (1991). 'Mortality predictors among 263 patients with rheumatoid arthritis'. J. Rheumatol. 18, p1307-12.
- Lieberman, S. (1998). 'A review of the effectiveness of Cimicifuga racemosa for the symptoms of the menopause'. Journal of womens health. 7, (5), p525-29.

Linde, K., Ramirez, G., Mulrow, C.D., Pauls, A., Weidenhammer, W., Melchart, D. (1996). 'St John's wort for depression-an overview and meta analysis of randomised clinical trials'. BMJ. 313, p253-8.

Liske, E. (1998). 'Therapeutic efficacy and safety of Cimicifuga racemosa for gynaecologic disorders'. Advances in therapy. 15 (1), p45-53.

Longscope, C., Hunter, R., Franz, C. (1980). 'Steroid secretion by the postmenopausal ovary'. Am. J. Obstet. Gynaecol. 138, p564-68.

Longscope, C., Franz, C., Morello, C., Baker, R., Johnson, C.C. (1986). 'Steroid and gonadotrophin levels in women during the peri-menopause years'. Maturitas. 8, p189-96.

MAFF. (1998). 'Cadmium mercury and other metals in food'. Food surveillance paper 53. The fifty-third report of the steering group on chemical aspects of food surveillance. London: The Stationary Office.

MCA. (2000). Fact sheet for health care professionals. Available from: <http://www.open.gov.uk-mca/mcahome.htm>

McCoy, J. (1996). 'Survey of Cimicifuga racemosa for phytoestrogenic flavonoids'. Abstracts of 212th ACS National Meeting, Orlando, Florida, 26-29th August (Abstract No. 082).

McKinlay, S.M., Brambilla, D.J., Posner, J.D. (1992). 'The normal menopause transition'. Maturitas. 14, p103-15.

Metcalf, M.G., Livesey, J.H. (1985). 'Gonadotropin excretion in fertile women: effect of age and the onset of the menopausal transition'. J. of Endocrinol. 105, p357-62.

Milanov, S. (1985). 'Tribestan, effect on the concentration of some hormones in the serum of healthy volunteers'. Medicobiologic information. 4, p27-29.

Murkies, A.L., Lombard, C., Strauss, B.J.G., Wilcox, G., Burger, H.G., Morton, M.S. (1995). 'Dietary flour Supplementation Decreases Postmenopausal Hot Flushes-Effect of Soy and Wheat'. Maturitas. 21, (3), p189-95.

Newall, C. (1996). Herbal medicines: a guide for health care professionals. London: The pharmaceutical press.

Patterson, C. (1996). 'Measuring outcomes in primary care: a patient generated measure, MYMOP, compared with the SF-36 health survey'. BMJ. (20th April) 312, p1016-20.

Patterson, C. (1997). 'Complementary practitioners as part of the primary health care team: consulting patterns, patient characteristics and patient outcomes'. Family Practice. 14 (5), p347-354.

- Pearce, D. (2000). 'HPLC for the Practicing chromatographer'. Berkshire: Thames Restek.
- Perry, N. (1996). 'European herbs with cholinergic activities: potential in dementia therapy'. Int. J. of Geriatric Psychiatry. 11, p1063-69.
- Pietta, P., Mauri, P., Bruno A. (1991). 'Identification of flavonoids from Ginkgo biloba L Anthemis nobilis L. and Equisetum arvense L. By high-performance liquid chromatography with diode-array UV detection'. J. of Chromatography. 553, p223-31.
- Perz, J.M. (1997). 'Development of the menopause symptom list: a factor analytic study of menopause associated symptoms'. Women & Health. 25, p53-69.
- Pocock, S.J. (1998). Clinical Trials: A Practical Approach. London: John Wiley and Sons.
- Rees, L. & Weil, A. (2001). 'Editorial: Integrated medicine'. BMJ. 322 (7279), p119-20.
- Rehwald, A., Meier, B., Sticher O. (1994). 'Qualitative and quantitative reversed-phase high-performance liquid chromatography of flavonoids in crataegus leaves and flowers'. J of Chromatography. 677, p25-33.
- Reznicek, G., Freiler, M., Schmidt, U. (1996). 'Determination of the content and the composition of the main saponins from Solidago gigantea AIT. Using high performance liquid chromatography'. J of Chromatography A. 755, p133-37.
- Richardson, S.J. (1990). 'Follicular depletion during the menopause transition'. Ann. N. Y. Acad. Sci. 592, p13-20.
- Richardson, S.J. (1993). 'The biological basis of the menopause'. Ballieres Clin. Endocrinol. Metab. 7, p1-16.
- Rogers, C. (1995). The womens guide to herbal medicine. London: Penguin.
- Rowles, S. (2000). Personal communication. Contaminants Division. The Food Standards Agency. London.
- Rules and guidance for pharmaceutical manufacturers and distributors. (1996). Manufacture of Investigational Medicinal Products. Annex 13. London: Stationery Office.
- Rules and guidance for pharmaceutical manufacturers and distributors. (1997). Manufacture of Herbal Medicinal Products. Annex 7. London: Stationery Office.
- Ruschitzka, F., Meier, P.J., Turina, M., Luscher, T.F., Noll, G. (2000). 'Acute heart plant rejection due to St John's wort'. The Lancet. 355, p548-549.

- Sabri, N.N., Asaad, A, Khafagy, S.M. (1981). 'Isolation of four Ecdysones from *Ajuga iva* roots and Rapid Semi-quantitative Method for Ecdysone Determination'. J of Med Plant Res. 42, p293-95.
- Samsoie, G. (1998). 'Urogenital ageing a hidden problem'. Am. J. Obstet. Gynecol. 178, p245-249.
- Schneider, H.P.G., Schultz-Zehden, M., Rosemeier, H.P. & Behre, H.M. (2000). 'Assessing well-being in menopausal women'. in J Studd (ed.). The management of the menopause: the millennium review. London: Parthenon, p11.
- Schneider, H.P.G., Heinemann, L.A.J., Rosemeier, H.P., Pothoff, P. & Behre, H.M. (2000). 'The Menopause Rating Scale (MRS): Reliability of Scores of Menopausal Complaints'. Climacteric. 3, p59-64.
- Sheehan, M.P., Rustin, M.H.A., Atherton, D.J., Buckley, C., Harris, D.J., Brostoff, J., Ostler, L., Dawson, A. (1992). 'Efficacy of Traditional Chinese Herbal Therapy in Adult Atopic-Dermatitis'. Lancet. Jul 4, 340 (8810), p13-17.
- Sheehy, G. (1992). The Silent Passage: Menopause. New York: Random House, p20.
- Sherman, B.M., West, J.H., Korenman, S.G. (1976). 'The menopause transition: analysis of LH, FSH, estradiol and progesterone concentrations during menstrual cycles of older women'. J. Clin. Endocrinol. Metab. 42, p629-36.
- Siddle, N. (1993). 'HRT: a paradox in prescribing'. Geriatric Medicine. 23 (11), p11-12.
- Siiteri, P.K. & MacDonald, P.C. (1973). 'Role of extraglandular estrogen in the human endocrinology'. in RO Greep, E Astwood, (eds.). Handbook of Physiology: Endocrinology. (Vol 2). Washington: American Physiology Society, p615-29.
- Silbergeld, E.K. (1998). 'Chemicals and the menopause: effects on age at menopause and on health status in the postmenopause'. J. Women's Health. 8, p227-234.
- Slemenda, C., Hui, S.L., Longscope, C., Johnson, C.C. (1987). 'Sex steroids and bone mass: a study of changes about the time of the menopause'. J. Clin. Invest. 80, p1261-69.
- Sloley, B.D., Urichuk, L.J., Ling, L., Gu, L.D., Coutts, R.T., Pang, P.K., Shan, J.J. (2000). 'Chemical and pharmacological evaluation of *Hypericum perforatum* extracts'. Acta Pharmacol. Sin. 21 (12), p1145-52.
- Smith, T. (1995). BMA complete family health encyclopaedia. London: Dorling Kindersley.
- Solerte, S.B., Fioravanti, M., Racchi, M. (1998). 'Menopause and estrogen deficiency as a risk factor in dementing illness: hypothesis on a biological basis'. Maturitas. 31, p95-101.

- Somekawa, Y., Chiguchi, M., Ishibashi, T., Aso, T. (2001). 'Soy intake related to menopausal symptoms, serum lipids, and bone mineral density in postmenopausal Japanese women'. Obstet. Gynecol. 97, p109-115.
- Southwell, I.A. & Bourke, C.A. (2001). 'Seasonal variation in hypericin content of *Hypericum perforatum* L. (St. John's wort)'. Phytochemistry. 56 (5), p437-41.
- Speroff, L. (1999). 'The menopause: A signal for the future treatment of the menopausal women'. in RA, Lobo (Ed.). Basics and Clinical Aspects. (2nd. ed.). Philadelphia: Lippincott Williams and Wilkins, p75.
- Stoll, W. (1987). 'Phytopharmakon influences atrophic vaginal epithelium: double-blind study- cimicifuga vs. estrogenic substances'. Therapeuticum. 1, p23-31.
- Stolze, H. (1982). 'Der andere Weg, klimakterischer Beschwerden zu behandeln'. Gyne. 3 (1), p626-629.
- Thieme, G. (1985). Qualitätskontroll von Phytopharmaka. Stuttgart: Verlag.
- Thompson LU, Robb, P and Serraino M. (1991). 'Mammalian ligan production from various foods'. Nutr Cancer. 16, p43-52.
- Tinker, P.B. (1981). 'Levels, distribution and chemical forms of trace elements in food plants'. Philos. Trans. R. Soc. London. 294b, p41.
- Tong S, Baghursy P, McMichael A, Michael S and Mudge S. (1996). 'Lifetime exposure to environmental lead and children's intelligence at 11-13 years: the Port Pirie cohort study'. BMJ. 312, p1569-75.
- Utian, W. & Schiff, A. (1994). 'The true clinical features of post menopause and oophorectomy, and their response to estrogen therapy'. S. Afr. Med. J. 46, p737-42.
- Valentao, P., Andrade, P., Areias, F., Ferreres, F., Seabra M. (1999). 'Analysis of Vervain flavonoids by HPLC/Diode Array Detector Method. Its Application to Quality control'. J Agric. Food Chem. 47, p4579-4582.
- Wake, G., Court, J., Pickering, A., Lewis, R., Wilikins, R., Perry, E. (2000). 'CNS acetylcholine receptor activity in European medicinal plants traditionally used to improve failing memory'. J Ethanopharmacol. 69, p105-114.
- Weeden, R.P. Poisons in the post: The legacy of lead. Southern Illinois University Press: Carbondale (1984).
- Wiklund, I., Dimenas, E.I., Wahl, M. (1990). 'Factors of importance when evaluating quality of life in clinical trials'. Control Clin. Trial. 11, p169-179.
- Wiklund, I., Karlberg, J., Lindgren, R., Sandin, K., Mattsson, L.A. (1993). 'A Swedish version of the womens heath questionnaire: a measurement of postmenopausal complaints'. Acta Obstet. Gynecol. Scand. 72, p648-55.

- Wiklund, I. (1998). 'Methods of assessing the impact of climacteric complaints on quality of life'. Maturitas. 29, p41-50.
- Williamson, E.M. (2001). 'Synergy and other interactions in phytomedicines'. Phytomedicine. 8, (5), p401-9.
- Windham, G.C., Elkin, E.P., Swan, S.H. (1999). 'Cigarette smoking and the effects on menstrual function'. Obstet. Gynecol. 93, p59-65.
- W.M.A. (1964). World Medical Association. Declaration of Helsinki. Ethical Principles for Medical Research Involving Human Subjects. Adopted by the 18th WMA General Assembly Helsinki, Finland, June 1964.
- Woelk, H. (2000). 'Comparison of St John's wort and imipramine for treating depression: randomised controlled trial'. BMJ. 321, (2nd September), p536-39.
- Wolfe, F. & Cathey, M. (1991). 'The assessment and prediction of functional disability in rheumatoid arthritis'. J Rheumatol. 18, p1289-306.
- Wolinsky, F.D. (1994). 'Gender, race and health: the structure of health status among older adults'. Gerontology. 34, p24-35.
- World Health Organisation. (1996). Research on the Menopause in the 1990's. Report of a WHO Scientific Group. WHO Technical Report Series No. 866.
- Yen, S.S. (1977). 'The Biology of the menopause'. J Reprod Med. 18, p287.
- Yue, Q.Y., Bergquist, C., Gerden, B. (2000). 'Safety of St John's wort'. The Lancet. 355, (9203), (Feb 12), p576.
- Zollman, C., Vickers, A. (1999). 'ABC of complementary medicine: users and practitioners of complementary medicine'. BMJ. 319, p836-838 (25 September).

Appendix I

Research Protocol Submitted to the University Ethics Committee

Background

Although menopause is a normal developmental process, the resulting decline in endogenous oestrogen levels can have serious clinical consequences. Oestrogen deficiency has been implicated in an increased risk for vasomotor symptoms, osteoporosis, cardiovascular disease, urogenital atrophy, cognitive decline, and Alzheimer's disease (Greendale, 1997).

Onset of menopause

Natural menopause occurs at a median age of 51.4 years, with a gaussian distribution ranging from 40-58 years. Several factors appear to determine the onset age for the menopause (Kato, 1998). Multiparity and increased body mass index are associated with later onset (Hardy, 1999), whereas smoking (Cramer, 1995; Windham, 1999) nullparity, medically treated depression, toxic chemical exposure and treatment of childhood cancer with abdominal-pelvic radiation and alkylating agents have been associated with a younger age of onset (Silbergeld, 1999).

Clinical features

One of the key symptoms in menopausal women is hot flushes (Bachmann, 1999), which can cause insomnia, irritability, fatigue, and reduced ability to concentrate. However, a recent study suggests that psychological changes commonly attributed to chronic sleep disturbance may be due to changing hormonal levels (Empson, 1998). Hot flushes typically last from 0.5 to 5 years after natural menopause but may persist for 15 years. They tend to last longer and be more severe with surgically induced menopause (Bachmann, 1999).

Hormone replacement therapy

Hormone replacement therapy (HRT) is given to relieve menopausal symptoms such as hot flushes and excessive sweating at night. HRT helps prevent atrophic vaginitis, osteoporosis and atherosclerosis (Smith, 1995). HRT consists of synthetic oestrogens that mimic the female hormones, or so-called natural (conjugated) oestrogen made from the urine of pregnant mares (premarin). Both are different in chemical structure

from natural hormones (Rogers, 1995). Side-effects from HRT include, nausea, vomiting, fluid retention, headaches, depression and uterine cancer (BNF, 1996).

Bone density and HRT

Studies have shown that only women who have taken HRT for 7 years had significantly higher bone density than women who had not taken oestrogen (Aloia, 1996). Even women who had been on oestrogen therapy for 10 years were not protected against fractures. Their bone density declined rapidly as soon as they stopped taking oestrogen. By the time they were between 75 and 80 years of age (the age at which most fractures happen) their bone density was only marginally higher than women of comparable age, who had not taken oestrogen (Glenville, 1997).

HRT Contraindications

In the USA, it has been estimated that between 10% to 35% of women are using HRT (Utian and Schiff, 1994), while in the UK, as few as 7 to 10% of women use HRT (Hunter, 1994). This low use of HRT has been attributed to women's unwillingness to use this treatment for a number of reasons, including concerns regarding the risks of breast cancer and other hormone dependent cancers, side-effects of the treatment and medicalisation of a normal physiological process (Siddle, 1993). In addition, there is a significant number of women who are unable to take HRT because of absolute or relative contra-indications (Barlow, 1992). A safe, efficacious alternative to HRT would therefore be welcome as a useful addition to available approaches to treating menopausal symptoms.

Phytoestrogens

Many different plants produce compounds that may mimic or interact with oestrogenic hormones in animals. More than 20 compounds have been identified in at least 300 plants from 16 different plant families. These compounds, referred to as phytoestrogens, are weaker than natural oestrogen and reside in herbs, grains and vegetables (Colborn, 1996).

Phytoestrogens have been investigated as treatment for the symptoms of the menopause and osteoporosis, as well as possible cancer preventatives. Laboratory experiments and comparisons of Asian and Western human populations suggest that

diet has a large role in these types of health problems. One study found that Asian populations that eat large amounts of soy products (which contain large amounts of phytoestrogens such as genistein and daidzein), have lower rates of hormone dependent cancers (breast, endometrial) and lower incidence of menopausal symptoms and osteoporosis than westerners (Barrett, 1996).

Plant Pharmacology

The principle compounds associated with phytoestrogen activity are isoflavones and plant steroidal saponins. The isoflavone biochanin A has been identified in *Cimicifuga racemosa* and this may in part be responsible for the menopausal therapeutic effect (McCoy, 1996). In general, plants containing steroidal saponins are thought to have a hormonal regulating action. Saponins from *Tribulus terrestris* appear to increase follicular stimulating hormone, which in turn increases levels of oestradiol (Milanov, 1985). This may happen via saponins weakly binding with hypothalamic oestrogen receptors, which are part of a negative feedback mechanism of oestrogen control (Bone, 2000). This may be the therapeutic mechanism behind saponin containing herbs such as *Glycyrrhiza glabra* (triterpenoid saponins) and *Dioscorea villosa* (saponins).

Clinical trials

Patient trials suggest that the herb, *Cimicifuga racemosa*, and soy based products containing isoflavonoids, are effective in the treatment of hot flushes (Brzezinski, 1999). Further studies have shown that soybeans and flaxseed have beneficial effects on vasomotor symptoms and bone health (Anderson, 1999).

The efficacy of *Cimicifuga racemosa* for menopausal symptoms was assessed in a review of eight clinical trials. The review concluded that extracts of the herb may be a safe and effective alternative therapy for cases where oestrogen replacement therapy was contraindicated, (Lieberman, 1998). One study using *Salvia officinalis* and *Medicago sativa* to treat menopausal symptoms found that out of thirty menopausal women, hot flushes and night sweats were relieved in twenty women and the remainder all showed improvements in their symptoms (De Leo, 1998).

Academic and Business collaboration

This project is a joint collaboration between Neal's Yard Remedies, Middlesex University and the Teaching Company Scheme (TCS), a government sponsored organisation linking businesses with Universities to provide mutual benefits and transfer of skills. Neal's Yard Remedies and Middlesex University have been awarded a research grant for the study from the Department of Trade and Industry. Currently the Herbal Medicine department at Middlesex University is establishing a research program to further the understanding and potential benefits of Herbal Medicine.

Aims of the project

The aim of this study is to develop an appropriate herbal formula, which will be used to alleviate symptoms of the menopause and to test its efficacy using a randomised, placebo controlled, double-blinded multicenter trial.

Research Question

Is the herbal formulation NYR10 more effective than placebo at treating symptoms of the menopause?

Methodology

Patient recruitment

A total of 400 patients will be recruited locally through the media and via leaflets and posters placed in Neal's Yard Remedies shops. The subjects will be drawn from three areas for each trial centre, London, Edinburgh and Cardiff. Patients will initially be screened by telephone and then asked to attend an appointment at one of the three trial centres.

Inclusion criteria:

- The absence of menstruation for at least six months.
- Active menopausal symptoms- e.g. hot flushes.
- The age-range for inclusion is 45-65 years.

Exclusion criteria:

- Patients who are currently taking HRT.
- Patients who have taken HRT within two months of the clinical trial commencing.
- Pregnancy
- Patients with cognitive difficulties who are unable to fill-in a self-administered questionnaire.

- Patients currently taking any drug whose bioavailability may be affected by interactions with *Hypericum perforatum* as listed in section 1.

Medical contraindications:

- Congestive heart failure
- History of hormonally dependent cancers
- Cancer
- Diabetes
- Glaucoma
- Psychiatric disorders (including, clinical depression)
- Chronic liver disease (hepatitis, liver cirrhosis)
- Kidney disease (nephritis)
- Epilepsy
- Currently being treated for HIV infection
- History of cerebral infarct
- Thyrotoxicosis

Treatment

Patients will be randomised into two groups, to receive either the formula or placebo.

Details of the formula and dosage are in section 1.

Data collection procedures

Response to treatment will be measured using The Women's Health Questionnaire (WHQ) (Hunter, 1991). After reviewing menopause specific questionnaires the WHQ was chosen as it was the most comprehensive and has been widely validated (Wiklund, 1993). The WHQ is a menopause specific quality of life questionnaire and is self-administered by each patient. A second questionnaire, the measure yourself medical outcome profile (MYMOP) (Patterson, 1996) will also be used. The questionnaire, while not specific to menopause, attempts to incorporate patient's personal experiences of illness into the measurement process and is proving to be a valuable tool in complementary health care settings. This involves the patient in deciding which symptoms or aspect of their illness are affecting them the most.

Data Analysis Techniques

The data generated from the questionnaire will be analysed using the Statistical Program for Social Science (SPSS). Non-parametric tests (Wilcoxin matched-pairs signed-rank test and the Friedman test) will be used to compare within patient change.

Planned Research Outputs

The publication of at least two research papers is planned after completion of the clinical trial.

Timescale for the proposed research

The clinical trial will run from Treatment for each patient will last for 12-weeks; an initial two-weeks without treatment (both active treatment and placebo group) to establish a baseline measurement, followed by 12-weeks of treatment with either the herbal formula or placebo.

Details of negotiated access

Permission has been granted by the NIMH Education Foundation to use the Archway Clinic of Herbal Medicine. Permission has been granted from Neal's Yard Remedies to use their own clinics at Cardiff and Edinburgh.

Specific ethical matters:**Confidentiality including record keeping**

Patient confidentiality will be respected at all times. Information held on each patient will be stored at the treatment clinics and by the researcher. No other person(s) will have access to the information. Information obtained will be kept in accordance with the 1998 data protection act. Middlesex University has existing registered cover with the data protection agency for the purpose of the study.

Nature of any inducement

Patients will not be offered an inducement for participating in the clinical trial.

Patient Consent

Informed consent will be sought from each patient as detailed in the example below.

Dear Madam,

The Archway clinic of Herbal Medicine is committed to providing a high level of care and service to its patients. Part of our work involves scientifically evaluating the role of herbal medicine in health care. Currently we are carrying out a study to measure how menopausal symptoms respond to treatment with herbal medicine. At this stage we would like to explain to you in more detail what you will be asked to do. After reading this letter, if you are still interested in taking part in the study you will be asked to sign in the space provided giving your consent to participate in the study.

Attending the Clinic

You will be asked to attend the clinic on four occasions. Today will be the first appointment. The next appointment will be in two-weeks time. The third appointment will be in 7-weeks time, the fourth will be in 12-weeks time. All appointments after today will last for approximately 20 minutes. During each consultation you will be asked questions regarding your general health and will be asked to complete two questionnaires. A routine physical examination may be required if concerns for your well-being are identified during the consultation. A qualified herbal medicine practitioner would carry this out.

The Treatment

During the 1st appointment your case history will be taken and the study will be explained to you. You will also fill in two questionnaires and receive the treatment, either a herbal medicine or a placebo. The placebo does not have any known therapeutic benefit. Neither you nor your herbal medicine practitioner will know whether you are receiving the herbal medicine or the placebo. This is to ensure that the study meets the highest standards for evaluating benefits to patients.

The Questionnaires

During each appointment you will be asked to complete two questionnaires. This is to measure whether you have experienced any changes in menopausal symptoms and general quality of life. Your practitioner will explain to you how to fill-in the questionnaires. You will be able to ask for advice at any time.

Benefits to patients

Previous studies have shown that certain herbs and plant products have been effective in reducing menopausal symptoms. Patients participating in this study will receive either the herbal therapy or the placebo. As you know, you may receive the herbal treatment but there is an equal chance that you will be given the placebo throughout the trial.

Risks of participation

The herbal medicines used for this study have been identified as safe to use in the dose being given in this study when taken on their own. However, interactions can occur between any medicines and it is therefore important that you inform your herbal practitioner of any other medicines you are taking. You should also inform your GP or health provider that you are taking herbal medicines.

Cost of participation

All consultations and medicines will be free of charge during your involvement in this study.

Standard clauses

1. The principal treatment and procedures in this project have been identified and explained to me in language that I can understand.
2. The expected benefits from the procedures have been explained to me.
3. The risks and discomforts from the procedures have been explained to me.
4. An offer has been made to me to answer any questions that I may have about these procedures. If I have any questions before, during or after the study, I may contact..... (name of practitioner).
5. I have been told that I may refuse to participate or stop my participation in this project at any time without any prejudice. All new findings during the course of this research, which may influence my desire to continue or not to continue to participate in this study, will be provided to me as such information becomes available.

6. If I have any questions regarding my rights as a subject participating in this study, I may contact..... (name of practitioner).

7. Information will be kept in accordance with the 1998 data protection act and only statistical information will be released without identifying you in any way. I have a right to privacy, and all information that is obtained in connection with this study and that can be identified with me will remain confidential. The results of this study may be published in scientific journals without identifying me by name.

8. I understand that by agreeing to participate in the trial that I may receive either a herbal medicine or placebo treatment. The placebo does not have any known therapeutic benefit.

9. I understand that if my GP or health provider prescribes medicines, I will need to inform them that I am currently taking herbal medicines.

I voluntarily agree to participate as a subject in the above named project. I understand that I will be given a copy of the consent form I have signed.

Date.....

Patient's name (Please print).....

Patient's signature

Evidence of undertaking appropriate risk assessment for the study

All five herbs selected for the clinical trial to be used in the formula have a long traditional use for the relief of menopausal symptoms. An herbal formula was chosen in preference to a single herb as this reflects current and historical use of herbal medicine in the UK to treat health disorders including menopausal symptoms. The herbs to be evaluated for the study are currently used by practising Medical Herbalists in the treatment of menopausal complaints and no serious side effects have been reported in clinical trials or relevant pharmacopoeias using dosage levels recommended in the British herbal Pharmacopoeia. Evidence of safety for the herbs to be used for the clinical trial has been established through empirical use and clinical studies. The herbs, *Hypericum perforatum*, *Cimicifuga racemosa* and *Glycyrrhiza glabra* have been shown in studies to be safe and efficacious (Linde, 1996; Liske, 1998; Bernardi, 1994).

Cimicifuga racemosa

Cimicifuga racemosa has been given in daily doses of 200mg without adverse affects, (Liske, 1998). Patient tolerance for *Cimicifuga racemosa* has been assessed as very good, with only gastrointestinal complaints of low frequency and degree having been reported in some studies (Stolze, 1982). The dosage to be used is more than one and a half times lower than the maximum recommended dosage as cited in Newall, (1996).

Hypericum perforatum

In clinical studies, *Hypericum perforatum* been shown to be well tolerated by patients, with an extremely low incidence of side effects (Kim, 1999). Concerns have arisen recently over potential interactions between prescribed medicines and *Hypericum perforatum*. Although some studies have been inconclusive, two clinical reports indicate that *Hypericum perforatum* increased the rate of metabolism of warfarin and cyclosporin and that blood levels were reduced by approximately 50% (Qin-Ying Yue, 2000; Ruschitzka, 2000). A study with *Hypericum perforatum* and digoxin also indicated that *Hypericum* potentiated the effect of the drug, however the placebo group had a 9% decrease in digoxin levels and therefore the variation may reflect known variability in digoxin distribution or systematic availability (Johne, 1999). Nonetheless, real concerns regarding potential interactions mean that *Hypericum perforatum* should not be used concurrently with a range of prescribed medications.

The trial will follow the guidelines required by the Medicines Control Agency (2000) and patients who are taking drugs with a potential for interaction with *Hypericum perforatum* will be excluded from the trial (see Appendix I). The dosage to be used is more than three times lower than the maximum daily dose recommended by the European Scientific Cooperation on Phytotherapy 1997 (ESCOP, 1997).

Glycyrrhiza glabra

Patients taking aqueous extracts of *Glycyrrhiza glabra* containing 814mg Glycyrrhetic acid have been shown to develop arterial hypertension after two-weeks of ingestion. Patients taking 108mg and 217mg of Glycyrrhetic acid daily did not develop any side effects including arterial hypertension (Bernardi, 1994). The daily dose of *Glycyrrhiza glabra* to be used in this study is 0.5 gram crude herb and will contain approximately 25mg Glycyrrhetic acid, which is eight times lower than the known safe concentration identified.

Salvia officinalis

Salvia officinalis (dried herb leaf) as reported in the ESCOP monograph 1997 has no known contraindications or interactions with other medicines. However, the use of *Salvia officinalis* is not recommended during pregnancy as a precautionary measure. The daily dosage to be prescribed in this trial is five times lower than the safe recommended dosage stated in the ESCOP, 1997 monograph for this herb.

Dioscorea villosa

Dioscorea villosa is a poorly researched medicinal plant, although it is one of the original sources of isolated steroids first used to create the contraceptive pill. It has longstanding traditional use in the treatment of menopausal conditions. The British Herbal Pharmacopoeia 1983, though a somewhat outdated pharmacopoeia, indicates that it is a safe remedy at recommended dosage levels. The daily dosage to be used in this study is five times lower than the maximum daily dosage recommended by the BHP 1983. No reports of toxicity at these dosages have been recorded.

Medicines Control Agency

An application to the Medicines Control Agency will be submitted for approval of the proposed clinical trial.

SECTION 1

Patients on the drugs listed are to be excluded from the trial

- HIV protease inhibitors (indinavir, nelfinavir, ritonavir, saquinavir)
- HIV non-nucleoside reverse transcriptase inhibitors (efavirenz, nevirapine)
- Warfarin
- Cyclosporin
- Oral contraceptives
- Anticonvulsants (carbamazepine, phenobarbitone, phenytoin)
- Digoxin
- Theophylline
- Triptans (sumatriptan, naratriptan, rizatriptan, zolmitriptan)
- SSRI's (citalopram, fluoxetine, fluvoxamine, paroxetine, sertraline)

(MCA, 2000)

Dosages to be used for the formula

Patients are to receive 4.50 grams daily of the formula, or the placebo for a total period of 12-weeks.

Proportion of herbs in the formula

- *Hypericum perforatum* 27.8%
- *Cimicifuga racemosa* 27.8%
- *Dioscorea villosa* 16.7%
- *Salvia officinalis* 16.7%
- *Glycyrrhiza glabra* 11.0%

References

- Aloia, J.F. (1996). 'Bone density measurements in menopausal women using HRT'. Osteoporosis Int. 6, p55-62
- Anderson, J.J. (1999). 'Plant based diets and bone health: nutritional implication'. Am J Clin Nutr. 70, p539-42
- Bachmann, G.A. (1999). 'Vasomotor flushes in postmenopausal women'. Am J Obstet Gynecol. 180, p312-16
- Barlow, D.H. (1992). 'HRT and other menopause associated conditions'. British Medical Bulletin. 48 (2), p356-67
- Barrett J. (1996). 'Phytoestrogens friends or foes?'. Environmental Health Perspectives. 104, p478-82
- Bernardi, M. (1994). 'Effects of prolonged ingestion of graded doses of licorice by healthy volunteers'. Life Sciences. 55 (11), p863-872
- Bone, K, and Mills, S. (2000). Principle and practice of phytotherapy. Churchill Livingstone: London, p46
- British Herbal Pharmacopoeia. (1983) British Herbal Medicines Associations: Bournemouth, UK
- British National Formulary. (1996) No.31, March, , BMA & Royal Pharmaceutical Society of GB, London
- Brzezinski, A. (1999). 'Phytoestrogens: the natural selective estrogen receptor modulators?' Eur J Obstet Gynecol Reprod Biol. 85, p47-51.
- Cramer, D.W. (1995). 'Cross sectional and case controlled analyses of the association between smoking and early menopause'. Maturitas. 22, p79-87
- Colborn, T. (1996). Our stolen futures. Penguin: New York, p16
- De Leo, V. (1998). 'Trattamento dei disturbi neurovegetativi della donna in menopausa con un preparato fitoterapico'. Minerva Ginecol.50, 207-11
- Empson, J.A. (1999). 'Effects of sex steroids on sleep'. Ann Med. 31, p41-45
- ESCOP, (1997). Monographs, Exeter: United Kingdom
- Glenville, M. 1997. Natural alternatives to HRT. Kyle Cathie Ltd, London.
- Greendale. G. 1997. 'Management of the menopause with HRT'. Endocrin Metab Clin North Am. 79, p261-77

- Hardy, R. (1999) 'Reproductive characteristics and the age at inception of the perimenopause in a British National Cohort' Am J Epidemiology. 149, p612-20
- Hunter, M.S. (1991). 'The Women's Health Questionnaire: A measure of mid-aged women's perceptions of their emotional and physical health'. Psychology and Health. 7, 45-54
- Hunter, M.S. (1994). 'Intentions to use HRT in a community sample of 45-year old women'. Maturitas. 20, p13-23
- Johne, A. (1999). 'Pharmokinetic interaction of digoxin with an herbal extract from St John's Wort'. Clin Pharmacol Ther. 66, p338-45
- Kato, I. (1998) 'Prospective study of factors influencing the onset of natural menopause'. J Clin Epidemiology. 51, p1271-1276
- Kim, HL. (1999). 'St John's wort for depression: a meta analysis of well-defined clinical trials'. J Nerv Ment Dis. 187 (9) p532-8
- Lieberman, S. (1998). 'A review of the effectiveness of Cimicifuga racemosa for the symptoms of the menopause'. Journal of womens health. 7, (5) 525-29
- Linde, K (1996). 'St John's Wort for depression-an overview and meta-analysis of randomised clinical trials'. BMJ. 313, p253-8
- Liske, E. (1998). 'Therapeutic efficacy and safety of Cimicifuga racemosa for gynaecologic disorders'. Advances in therapy. 15 (1), p45-53
- MCA, (2000). Fact sheet for health care professionals. www.open.gov.uk-mca/mcahome.htm
- McCoy, J. (1996). Survey of Cimicifuga racemosa for phytoestrogenic flavonoids. Abstracts of 212th ACS National Meeting, Orlando Florida, 26-29th August (Abstract No. 082)
- Milanov, S. (1985). 'Tribestan, effect on the concentration of some hormones in the serum of healthy volunteers'. Medicobiologic information. 4, p27-29
- Newall, C. (1996). Herbal medicines a guide for health care professionals. The pharmaceutical press: London
- Patterson, C. (1997). 'Complementary practitioners as part of the primary health care team: consulting patterns, patient characteristics and patient outcomes'. Family Practice. 14 (5), p347-354
- Qin-Ying Yue, (2000). 'Safety of St John's Wort'. The Lancet. (feb 12) 355 (Issue 9203), p576
- Rogers, C. (1995) The women's guide to herbal medicine. Penguin, London

- Ruschitzka, F, (2000). 'Acute heart plant rejection due to St John's Wort'. The Lancet. 355, p548-549
- Siddle, N. (1993). 'HRT: a paradox in prescribing'. Geriatric Medicine. 23 (11), p11-12
- Silbergeld, E.K. (1998) 'Chemicals and the menopause: effects on age at menopause and on health status in the postmenopause'. J. Women's Health. 8, p227-234
- Smith, T. (1995). BMA complete family health encyclopaedia. Dorling Kindersley, London.
- Stolze, H. (1982). 'Der andere Weg, klimakterischer Beschwerden zu behandeln'. Gyne. 3 (1) p626-629
- Utian W, Schiff, A. (1994) 'The true clinical features of postmenopause and oophorectomy, and their response to estrogen therapy'. S. Afr. Med. J. 46, p737-42
- Wiklund, I. (1993). 'A Swedish version of the womens heath questionnaire: a measurement of postmenopausal complaints'. Acta obstet Gynecol Scand. 72, p648-55
- Windham, G.C. (1999) 'Cigarette smoking and the effects on menstrual function'. Obstet Gynecol. 93, p59-65

Appendix II

Practitioner's Operations Manual

Background to the Study

The Study is a joint project between Neal's Yard Remedies and Middlesex University. The clinical trial aims to evaluate the role of herbal medicines to relieve symptoms of the menopause. The trial will operate from three clinics, the Archway Clinic of Herbal Medicine in London and Neal's Yard Remedies clinics at Cardiff and Edinburgh. The trial will be co-ordinated from the Archway Clinic of Herbal Medicine. The Archway clinic will see approximately 300 patients during the trial. Neal's Yard Remedies will see 50 patients at each clinic.

Patients will be recruited through advertisements in the London, Edinburgh and Cardiff area. Although patients will initially be telephone-screened centrally at the Archway clinic, they will be referred to their local clinic to arrange appointments. Patients will receive either a herbal treatment or placebo, which will be administered for 12 weeks. Patients will be assessed over 12-weeks with four appointments scheduled for weeks 1, 2, 7 and 12. Outcomes will be measured using two questionnaires.

Patient screening

The screening process is to ensure that patients meet the entrance criteria. If accepted patients are given the telephone number of their local clinic, to arrange an appointment with the practitioner. The patients will be randomly allocated to a treatment group and issued with a **trial number** in time for the **1st consultation**. This information will be returned to your clinic by fax, so that the practitioner will know the patient's trial number and which treatment to prescribe. To ensure this process happens smoothly, the appointments will need to be held 1 week *after* the screening process to enable the patient's personal details to be recorded by the co-ordination centre at the Archway Clinic of Herbal Medicine.

An example will clarify this process:

After the initial telephone screening, the patients' details will be entered onto a

database and a trial number with the treatment they are to receive will be issued. This information (see example below) will be sent back to *your* clinic ready for the 1st consultation.

Example of details returned to each clinic before the 1st consultation:

Name Angela Smith
Age 50
D.O.B 20th February 1951
Trial No. 45
Trial Centre Archway
Treatment 614

Thus, each patient will have a unique trial number and will be randomly allocated to receive either the herbal treatment or placebo. Neither the practitioners nor the evaluator will know which treatment the patients are receiving.

Patient eligibility criteria

During the 1st consultation the patient will need to be reassessed to ensure that they meet the entry criteria (Table 1). There are four sections, which need to be reviewed:

1. Inclusion criteria
2. Exclusion criteria
3. Medical contraindications
4. Drug exclusion criteria

Table 1. Patient screening criteria for eligibility
<p>1. Inclusion criteria:</p> <ul style="list-style-type: none"> ● The age-range for inclusion is 45-65 years. ● Active menopausal symptoms- i.e. (6 hot flushes during the past week). ● The absence of menstruation for at least six months
<p>2. Exclusion criteria:</p> <ul style="list-style-type: none"> ● Patients who are currently taking HRT. ● Patients who have taken HRT within two-months of the clinical trial commencing. ● Patients with cognitive difficulties and are unable to fill in a self-administered questionnaire.
<p>3. Medical contraindications:</p> <ul style="list-style-type: none"> ● Congestive heart failure

- Diabetes
- Glaucoma
- Psychiatric disorders (including clinical depression)
- Chronic liver disease (hepatitis, liver cirrhosis)
- Kidney disease (nephritis)
- Epilepsy
- History of cerebral infarct
- Thyrotoxicosis
- Uncontrolled hypertension
- Cancer or history of hormonally dependent cancers
- HIV infection

4. Drug contraindication:

- Warfarin
- Cyclosporin
- Digoxin
- Anticonvulsants: (carbamazepine, phenobarbitone, phenytoin)
- Theophylline
- Tamoxifen
- Triptans: (sumatriptan, naratriptan, rizatriptan, zolmitriptan)
- SSRI's: (citalopram, fluoxetine, fluvoxamine, paroxetine, sertraline)
- HIV medication: (indinavir, nelfinavir, ritonavir, saquinavir efavirenz, nevirapine)

Treatment

The medicines will be dispensed at each clinic. The containers will have the patient's name and unique treatment number. Patients will receive, in addition to their treatment schedule, an additional 1 weeks supply of medicine to allow for continuation of treatment if an appointment date is missed.

Questionnaire completion

Response to treatment will be measured using The Women's Health Questionnaire (WHQ). The WHQ is a menopause-specific quality of life questionnaire and is self-administered by each patient. A second questionnaire, the Measure Yourself Medical Outcome Profile (MYMOP) will also be used. The questionnaire, while not specific to menopause, attempts to incorporate patients' personal experiences of illness into the measurement process. This involves the patient in deciding which symptoms or aspect of their illness are affecting them the most. Patients will need to fill-in two questionnaires at each consultation. The patient's records including both questionnaires will need to be photocopied and sent to The Archway Clinic of Herbal Medicine, which will act as the co-ordination centre for the 3 trial centres.

Adverse event reporting card

Patients will be given an adverse event form to record any suspected reactions to the treatments. Patients will need to return the form on each appointment day and will be issued with a new form on each visit. The returned forms are to be copied and sent to the Archway clinic along with copies of the case notes and questionnaires.

Informed consent

Informed consent will be sought from each patient. Patients will be asked to read and sign the consent letter once the consultation is completed.

Confidentiality including record keeping

Patient confidentiality will be respected at all times. Information held on each patient will be stored at the treatment clinics and by the researcher. Only the researcher, practitioners and the medical consultant involved will have access to the information. NYR clinics will send copies of the case notes, questionnaires and adverse event forms to the Archway co-ordination centre.

Nature of any inducement

Patients will not be offered an inducement/payment(s) for participating in the clinical trial. No charge is to be made to patients for their involvement in the trial, including consultations and treatment.

Patient assessment

It is important to ensure that patients have no serious medical condition that would determine it inappropriate for them to participate in the trial. The patient's health status needs to be assessed against the medical and drug contraindications list for entry into the study. However, if you feel that the patient is too ill to be included into the study for a reason not cited on the medical contraindication list, then you must use your clinical judgement and exclude the patient if necessary. Go through each section in turn, using screening questions for each system and probe if further information is needed. For example, if a patient has stated that she does not have hepatitis, and yet is showing clinical signs of jaundice, then she must be excluded from the study and referred to her GP.

Physical examinations

Physical examinations should be performed only when there is a clinical need. If a concern arises during the consultation, the appropriate physical examination must be performed. Therefore if you suspect that the patient has cardiovascular abnormalities then a CVS examination should be performed.

PRACTITIONER INSTRUCTIONS

1st CONSULTATION

Procedure to be followed:

i) **Personal details:** The duration of the first appointment should last no longer than 40-minutes. Record the patient's personal details using the *patient's case history notes* (section 1), including her *trial* and *treatment* numbers. Check that the patient meets the age range criteria, and record her demographic details.

ii) **Screening:** Go through the screening check-list (questions 1-6) with each patient to ensure that the inclusion/exclusion criteria is met.

iii) **Previous Medical History:** Ask the patient about her past medical history and record the details.

iv) **Systematic enquiry:** Go through each system (CVS, RS, GIT, US, LM, NS, Repro) using the screening questions to check the patient's health status. If concerns arise, follow up with further enquiries and physical examination(s) if required.

v) **Blood Pressure:** Take the patient's blood pressure and record the findings.

vi) Informing patients

Once the health screening is completed explain, briefly, to the patient what the study involves using the form provided (section 3).

vii) **Consent form:** Give the patient the consent form and explain to the patient her rights. Ask the patient to sign if she agrees to participate. Give a copy of the consent form to each patient.

viii) **Questionnaires:** Give the patient the Women's Health Questionnaire and the MYMOP questionnaire to fill in. You will need to give assistance to the patient to fill in the MYMOP questionnaire.

ix) **Medicine:** Dispense the medicine to the patient (**2 weeks**)

x) **Adverse Event Form:** Give the adverse event form to the patient (section 6). Explain how the form should be completed using the instruction (section 5) and remind the patient to return the form at the next appointment.

xi) **Next appointment:** Give the patient her appointment date and time.

2nd CONSULTATION

Procedure to be followed:

- i) **Case-notes:** Review the case-notes and highlight any areas of concern with the patient. Enquire about her well-being and how she has been coping with the medicine.

- ii) **Adverse events:** Check the adverse event card and follow up with further questions if necessary.

- iii) **Compliance:** Check the patient's compliance with the medicine and record the findings.

- iv) **Blood Pressure:** Take the patient's blood pressure and record the findings.

- v) **Medicine:** Dispense the medicine to the patient (**5-weeks**)

- vi) **Adverse event card:** Give the patient a new adverse event card.

- vii) **Questionnaires:** Assist the patient to complete the MYMOP questionnaire and give the (WHQ) to the patient for completion after the consultation.

3rd CONSULTATION

Procedure to be followed:

- i) **Case-notes** Review the case-notes and highlight any areas of concern with the patient. Enquire about her well being and how she has been coping with the medicine.
- ii) **Adverse events:** Check the adverse event card and follow up with further questions if necessary.
- iii) **Compliance:** Check the patient compliance with the medicine and record the findings.
- iv) **Blood Pressure:** Take the patient's blood pressure and record the findings.
- v) **Medicine:** Dispense the final treatment to the patient- (**5-weeks**) medicine.
- vi) **Adverse event card:** Give a new adverse event card to the patient.
- vii) **Questionnaires:** Assist the patient to complete the MYMOP questionnaire and give the (WHQ) to the patient for completion after the consultation.

4th CONSULTATION

Procedure to be followed:

- i) **Case-notes** Review the case-notes and highlight any areas of concern with the patient. Enquire about her well-being and how she has been coping with the medicine.
- ii) **Adverse events:** Check the adverse event card and follow up with further enquiries if required.
- iii) **Compliance:** Check the patient's compliance with the medicine and record the findings.
- iv) **Blood Pressure:** Take the patient's blood pressure and record the findings.
- v) **Questionnaires:** Assist the patient to complete the MYMOP questionnaire and give the (WHQ) to the patient for completion after the consultation.

Section 1

Patient Case History Notes

Name:.....

Date of 1st Appointment:.....

Trial No:.....

Treatment number.....

Address:.....

.....

.....

Post code.....

Telephone No. Home:.....

Work:.....

D.O.B:.....

Age:..... Age between 45-65 years - **proceed**

Age is lower than 45 or greater than 65 - **exclude** the patient

Clinic attending: (please circle to indicate) Archway Cardiff Edinburgh

Weight

Height

Marital status:.....

Occupation:.....

Children: Yes/No.....

If Yes, number of children.....

Do you smoke? Yes/No.....

If Yes, average amount per week.....

Do you drink alcohol? Yes/No.....

1 unit of alcohol = 1/2 pint beer, 1 glass of wine, 1 glass of sherry or 1 measure of spirits
--

Yes, average units per week.....

Do you take exercise? Yes /No.....

If Yes, which type of exercise(s).....

How often per week?.....

Screening check-list:

Check that the patient is eligible for entry onto the study

1) **When did you have your last menstrual period?**Months/Years

If the last menstrual period occurred less than 6-months ago, **exclude** the patient

2) **Do you have hot flushes or sweats?**Yes/No

No- exclude the patient

Yes- How many hot flushes do you have each day?.....Per/day

If the patient has hot flushes less than once per day, **exclude**

3) **Are you taking *or* have you taken HRT in the last 2months?**.....Yes/No

If yes- **exclude**

4 **Do you have any serious health condition?**.....Yes/No

If yes, please state.....

5) **Do you have any of the following conditions?**

N.B. please mark-off each condition with an **X** for *no* and, with a tick if *yes*

- Heart disease.....
- Diabetes.....
- Glaucoma.....
- Chronic liver disease (hepatitis, liver cirrhosis).....
- Kidney disease (nephritis).....
- Epilepsy.....
- History of strokes.....
- Thyrotoxicosis.....
- Uncontrolled hypertension.....
- Psychiatric disorders (including clinical depression).....
- Cancer or history of hormonally dependent cancers.....
- HIV infection.....

Exclude the patient if she has *one or more* of the above conditions

6) Current medication:

Are you taking any drugs from your GP or hospital Doctor?.....Yes/No

Are you taking any self-prescribed medication?.....Yes/No

Exclude the patient if any of the contraindicated drugs are being taken

Drug contraindication list

- Warfarin.....
- Anticonvulsants (carbamzepine, phenobarbitone, phenytoin).....
- Digoxin.....
- Theophylline.....
- Triptans (sumatriptan, naratriptan, rizatriptan, zolmitriptan).....
- SSRI's (citalopram, fluoxetine, fluvoxamine, paroxetine, sertraline).....
- Tamoxifen.....
- Cyclosporin.....
- HIV medication (indinavir, nelfinavir, ritonavir, saquinavir)
efavirenz, nevirapine).....

Previous medical history:

Any serious illnesses?
Any operations/
hospitalisations?

Cardiovascular system

Chest pain
Palpitations
SOB
Peripheral oedema

Respiratory system

Cough
Sputum production
Haemoptysis
Breathlessness
Wheezing

Gastrointestinal system

Heartburn/indigestion Nausea/ Vomiting Blood in stools Constipation Diarrhoea Recent weight loss Dysphagia
--

Urological system

Urinary frequency Pain on passing urine Lower back pain Incontinence

Musculoskeletal system

Muscle weakness Join pain Muscle pain

Nervous system

Visual problems Hearing problems Headaches Fits/faints/blackouts Muscle weakness
--

Reproductive system

Any Bleeding

Blood pressure:.....

Findings on physical examination(s)



2nd appointment date.....

3rd appointment date.....

4th appointment date.....

Section 2

Telephone Checklist for Patient Eligibility

Prior to appointments, patients will be pre-screened to ensure they meet the inclusion and exclusion criteria listed below. Go through the checklist with patients so as to enable you to decide whether to proceed or whether to exclude the patient. Patients will need to meet all the criteria set out below before they can be entered onto the study.

If the patient has met all the inclusion criteria, then record her personal details.	
Ask the patient:	
1. Name.....	
2. Date of Birth.....	
3. Age.....	
4. Address.....	
.....	
5. Telephone no.....	
6. Clinic the patient is attending	
(Circle one, which applies)	Archway Cardiff Edinburgh

Inclusion/ exclusion criteria:

Ask all the patients the following questions:

1. **What is your age?**.....(Years)

If her age is lower than 45, or greater than 65, **exclude** the patient

2. **When did you have your last menstrual period?**Months/Years

If the last menstrual period occurred less than 6-months ago, **exclude** the patient

3. **Do you have hot flushes or sweats?**Yes/No

No- exclude the patient

Yes- How many hot flushes do you have each day?.....Per/Day

If the patient has hot flushes less than once per day, **exclude**

4. **Are you taking *or* have you taken HRT in the last 2 months?**.....Yes/No

If yes- **exclude**

5. **Do you have any serious health condition?**.....Yes/No

If yes, please state.....

6. Do you have any of the following conditions?

N.B. please mark-off each condition with an **X** for *no* and, with a **tick** for *yes*

- Heart disease.....
- Diabetes.....
- Glaucoma.....
- Chronic liver disease (hepatitis, liver cirrhosis).....
- Kidney disease (nephritis).....
- Epilepsy.....
- History of strokes.....
- Thyrotoxicosis.....
- Uncontrolled hypertension.....
- Psychiatric disorders (including, clinical depression).....
- Cancer or a history of hormonally dependent cancers.....
- HIV infection.....

Exclude the patient if she has any of the above conditions

7. Are you taking medication from your Doctor?Yes/ No

Yes, Go through the drug list with the patient to see if she is taking any contraindicated medication. If the patient is taking any medicine(s) on the list, then **exclude** the patient.

Drug contraindication list

N.B. Please mark-off each condition with an **X** for *no* and, with a **tick** for *yes*

- Warfarin.....
- Cyclosporin.....
- Anticonvulsants (carbamazepine, phenobarbitone, phenytoin).....
- Digoxin.....
- Theophylline.....
- Triptans (sumatriptan, naratriptan, rizatriptan, zolmitriptan).....
- SSRI's (citalopram, fluoxetine, fluvoxamine, paroxetine, sertraline).....
- Tamoxifen
- HIV medication (indinavir, nelfinavir, ritonavir, saquinavir efavirenz, nevirapine).....

Section 3

Patient Allocation Form

Once the patient has been given an appointment, fill in the section below and send the details immediately to the Archway co-ordination centre.

1. Name.....

2. Patient's D.O.B.....

3. Patient's age.....

4. Date of 1st appointment.....

5. Address.....

6. Telephone number.....

7. Indicate which clinic the patient is attending

(*circle* the one which applies)

Archway

Cardiff

Edinburgh

Section 4

Instruction Sheet for Patients Entered onto the Trial

Please use the following information to explain to patients what the study involves.

1. The study is to evaluate the benefits of herbal medicine to alleviate symptoms of the menopause
2. The treatment you will receive will be either a herbal medicine or placebo
3. We will be asked to fill in 2 short questionnaires at each visit to measure changes in symptoms
4. The potential benefits of the treatment are an improvement in your menopausal symptoms and general well-being
5. The herbal treatment or placebo being given has been identified as safe although we will monitor your well-being during the 12 weeks as part of our policy of patient care
6. The study will last for 12 weeks. During this time, you may stop your involvement with the study
7. During the 12-weeks, you will be seen on 4 occasions, today being the first appointment
8. You can contact (name of practitioner & clinic) if you have any questions about this study
9. Is there anything you would like to ask?

Section 5

Adverse Event Instruction Sheet

Give each patient an adverse event Report Form

Explain to the patient that:

Although the medicine(s) are safe, as part of our policy for patient care, we would like to monitor your well being throughout the study for any potential reactions to the medicine. Therefore, if you experience any complaints or symptoms, record them on the record card. Please record all complaints or symptoms even if they appear unrelated and insignificant. It is not necessary to record the symptoms you would normally experience during the menopause.

Section 6 Adverse Event Report Form

Patient Details: Name _____ D.O.B. _____					
Trial Number _____					
If you experience a symptom or complaint other than what you would normally experience during the menopause, please write them down on the form below.					
<p>For Example: If you should experience a skin rash whilst taking the medicine, then write down the following: <i>Symptom/complaint</i> (e.g. red skin rash on hand) <i>Onset</i> (e.g. 12th March) <i>Until</i> (13th March) <i>Severity</i> using either mild moderate, or severe to indicate the severity</p>					
Example of a reporting reaction					
Symptom/complaint	Onset Date	Until Date	Mild	Severity	
<u>Red Skin Rash on hand</u>	<u>12th March</u>	<u>14th March</u>	<u>X</u>	_____	_____
Symptom/complaint	Onset Date	Until Date	Mild	Severity	Severe
_____	_____	_____	_____	_____	_____
_____	_____	_____	_____	_____	_____
_____	_____	_____	_____	_____	_____
_____	_____	_____	_____	_____	_____
_____	_____	_____	_____	_____	_____
_____	_____	_____	_____	_____	_____
_____	_____	_____	_____	_____	_____
_____	_____	_____	_____	_____	_____
_____	_____	_____	_____	_____	_____
_____	_____	_____	_____	_____	_____
_____	_____	_____	_____	_____	_____
_____	_____	_____	_____	_____	_____
_____	_____	_____	_____	_____	_____
_____	_____	_____	_____	_____	_____
_____	_____	_____	_____	_____	_____
_____	_____	_____	_____	_____	_____
_____	_____	_____	_____	_____	_____
_____	_____	_____	_____	_____	_____
_____	_____	_____	_____	_____	_____
_____	_____	_____	_____	_____	_____
_____	_____	_____	_____	_____	_____
_____	_____	_____	_____	_____	_____
_____	_____	_____	_____	_____	_____
_____	_____	_____	_____	_____	_____
_____	_____	_____	_____	_____	_____
_____	_____	_____	_____	_____	_____
_____	_____	_____	_____	_____	_____

Are you suffering from **Menopausal** symptoms?

Why not volunteer for a major clinical trial to assess the benefits of **Herbal Medicine** to relieve menopausal symptoms?

- Pick up a leaflet inside for more information
- Or call 020 8362 0000 for more information

Locations: London, Cardiff and Edinburgh



National Institute of
Medical Herbalists

Are you suffering from Menopausal symptoms?

Why not volunteer for a major clinical trial to assess the benefits of

Herbal Medicine

to relieve menopausal symptoms?



National Institute of
Medical Herbalists

- Are you a woman aged between 45 and 65?

- Experiencing menopausal symptoms?

- Had your last period 6-months ago or longer?

- Have never used HRT or have been off it for 8 weeks?

- If you answered yes to *all* of these questions, then you may be able to participate in a clinical trial using herbal medicine.

Locations: London, Cardiff and Edinburgh.

Herbal medicine has traditionally been used for the relief of menopausal symptoms such as hot flushes, night sweats, insomnia and other symptoms. Until now, little clinical research has been done to evaluate the benefits of herbs.

Hormone Replacement Therapy (HRT) is the conventional treatment for menopausal complaints. However, some women are unable to take HRT due to side-effects, whilst many women prefer to use a natural alternative.

The trial will last for 12 weeks and will involve 4 short consultations at the clinic. All the clinics are run by NIMH qualified practitioners. The medicine you receive will be in capsule. This is a double blind placebo controlled trial.

For more information about the research study call our research co-ordinator on:
020 8362 0000

Appendix V

Tuesday	Group A					
13 th March	A1	Group B				
20 th March		B1				
27 th March	A2					
3 rd April		B2	Group C			
10 th April			C1	Group D		
17 th April				D1		
24 th April			C2			
1st May	A3			D2		Group F
8 th May		B3			Group E	F1
15 th May					E1	
22 nd May						F2
29 th May			C3		E2	
5 th June	A4			D3		
12 th June		B4				
19 th June						
26 th June						F3
3 rd July			C4		E3	
10 th July				D4		
17 th July						
24 th July						
31 st July						F4
7 th August					E4	
Group A	8 patients					
Group B	8 patients					
Group C	8 patients					
Group D	8 patients					
Group E	8 patients					
Group F	5 patients					

Appendix VI

Please indicate how you are feeling now, or how you have been feeling THE LAST FEW DAYS, by putting a tick in the appropriate box to indicate your answer for each statement :

	Yes, definitely	Yes, sometimes	No, rarely	No, not at all
1. I wake during the night and then sleep badly	<input type="checkbox"/>	<input type="checkbox"/>	<input type="checkbox"/>	<input type="checkbox"/>
2. I get very frightened and have panic feelings for no apparent reason	<input type="checkbox"/>	<input type="checkbox"/>	<input type="checkbox"/>	<input type="checkbox"/>
3. I feel miserable and sad	<input type="checkbox"/>	<input type="checkbox"/>	<input type="checkbox"/>	<input type="checkbox"/>
4. I feel anxious when I go out of the house on my own	<input type="checkbox"/>	<input type="checkbox"/>	<input type="checkbox"/>	<input type="checkbox"/>
5. I have lost interest in things	<input type="checkbox"/>	<input type="checkbox"/>	<input type="checkbox"/>	<input type="checkbox"/>
6. I get palpitations in my chest or a sensation of "butterflies" in my stomach	<input type="checkbox"/>	<input type="checkbox"/>	<input type="checkbox"/>	<input type="checkbox"/>
7. I still enjoy the things I used to	<input type="checkbox"/>	<input type="checkbox"/>	<input type="checkbox"/>	<input type="checkbox"/>
8. I feel life is not worth living	<input type="checkbox"/>	<input type="checkbox"/>	<input type="checkbox"/>	<input type="checkbox"/>
9. I feel tense or "wound up"	<input type="checkbox"/>	<input type="checkbox"/>	<input type="checkbox"/>	<input type="checkbox"/>
10. I have a good appetite	<input type="checkbox"/>	<input type="checkbox"/>	<input type="checkbox"/>	<input type="checkbox"/>
11. I am restless and can't keep still	<input type="checkbox"/>	<input type="checkbox"/>	<input type="checkbox"/>	<input type="checkbox"/>
12. I am more irritable than usual	<input type="checkbox"/>	<input type="checkbox"/>	<input type="checkbox"/>	<input type="checkbox"/>
13. I worry about growing old	<input type="checkbox"/>	<input type="checkbox"/>	<input type="checkbox"/>	<input type="checkbox"/>

Please indicate how you are feeling now, or how you have been feeling THE LAST FEW DAYS, by putting a tick in the appropriate box to indicate your answer for each statement :

	Yes, definitely	Yes, sometimes	No, rarely	No, not at all
14. I get headaches	<input type="checkbox"/>	<input type="checkbox"/>	<input type="checkbox"/>	<input type="checkbox"/>
15. I feel more tired than I usually do	<input type="checkbox"/>	<input type="checkbox"/>	<input type="checkbox"/>	<input type="checkbox"/>
16. I have dizzy spells	<input type="checkbox"/>	<input type="checkbox"/>	<input type="checkbox"/>	<input type="checkbox"/>
17. My breasts feel tender or uncomfortable	<input type="checkbox"/>	<input type="checkbox"/>	<input type="checkbox"/>	<input type="checkbox"/>
18. I suffer from pain in my back, arms and legs	<input type="checkbox"/>	<input type="checkbox"/>	<input type="checkbox"/>	<input type="checkbox"/>
19. I get hot flushes	<input type="checkbox"/>	<input type="checkbox"/>	<input type="checkbox"/>	<input type="checkbox"/>
20. I am more clumsy than usual	<input type="checkbox"/>	<input type="checkbox"/>	<input type="checkbox"/>	<input type="checkbox"/>
21. I feel rather lively and enthusiastic	<input type="checkbox"/>	<input type="checkbox"/>	<input type="checkbox"/>	<input type="checkbox"/>
22. I have abdominal (tummy) cramps or discomfort.....	<input type="checkbox"/>	<input type="checkbox"/>	<input type="checkbox"/>	<input type="checkbox"/>
23. I feel sick or nauseated.....	<input type="checkbox"/>	<input type="checkbox"/>	<input type="checkbox"/>	<input type="checkbox"/>
24. I have lost interest in sexual activity	<input type="checkbox"/>	<input type="checkbox"/>	<input type="checkbox"/>	<input type="checkbox"/>
25. I feel good in myself	<input type="checkbox"/>	<input type="checkbox"/>	<input type="checkbox"/>	<input type="checkbox"/>
26. I have heavy periods	<input type="checkbox"/>	<input type="checkbox"/>	<input type="checkbox"/>	<input type="checkbox"/>
(please omit if no periods at all)				
27. I suffer from night sweats	<input type="checkbox"/>	<input type="checkbox"/>	<input type="checkbox"/>	<input type="checkbox"/>

Please indicate how you are feeling now, or how you have been feeling THE LAST FEW DAYS, by putting a tick in the appropriate box to indicate your answer for each statement

	Yes, definitely	Yes, sometimes	No, rarely	No, not at all
28. My stomach feels bloated	<input type="checkbox"/>	<input type="checkbox"/>	<input type="checkbox"/>	<input type="checkbox"/>
29. I have difficulty in falling asleep.....	<input type="checkbox"/>	<input type="checkbox"/>	<input type="checkbox"/>	<input type="checkbox"/>
30. I often have a feeling of pins and needles in my hands and feet	<input type="checkbox"/>	<input type="checkbox"/>	<input type="checkbox"/>	<input type="checkbox"/>
31. I am satisfied with my current sexual relationship	<input type="checkbox"/>	<input type="checkbox"/>	<input type="checkbox"/>	<input type="checkbox"/>
(please omit if not sexually active)				
32. I feel physically attractive	<input type="checkbox"/>	<input type="checkbox"/>	<input type="checkbox"/>	<input type="checkbox"/>
33. I have difficulty in concentrating.....	<input type="checkbox"/>	<input type="checkbox"/>	<input type="checkbox"/>	<input type="checkbox"/>
34. As a result of vaginal dryness sexual intercourse has become uncomfortable	<input type="checkbox"/>	<input type="checkbox"/>	<input type="checkbox"/>	<input type="checkbox"/>
(please omit if not sexually active)				
35. I need to pass urine/water more frequently than usual.....	<input type="checkbox"/>	<input type="checkbox"/>	<input type="checkbox"/>	<input type="checkbox"/>
36. My memory is poor	<input type="checkbox"/>	<input type="checkbox"/>	<input type="checkbox"/>	<input type="checkbox"/>
37. Is it very difficult to cope with any of the above symptoms? Please list them below:				

Appendix VII

MYMOP2

Full name..... Date of birth

Address and postcode

Today's date Practitioner seen.....

Choose one or two symptoms (physical or mental) which bother you the most. Write them on the lines.

Now consider how bad each symptom is, over the last week, and score it by circling your chosen number.

SYMPTOM 1: 0 1 2 3 4 5 6

..... As good as it could be As bad as it could be

.....

SYMPTOM 2: 0 1 2 3 4 5 6

..... As good as it could be As bad as it could be

.....

Now choose one activity (physical, social or mental) that is important to you, and that your problem makes difficult or prevents you doing.

Score how bad it has been in the last week

ACTIVITY : 0 1 2 3 4 5 6

..... As good as it could be As bad as it could be

.....

Lastly, how would you rate your general feeling of wellbeing during the last week ?

0 1 2 3 4 5 6

As good as it could be As bad as it could be

How long have you had your Symptom 1, either all the time or on and off ?

Less than 2 weeks 2-4 weeks 4-12 weeks

3 months- 1 year Over 1 year

Tick the box which best describes how you feel:

Cutting down or avoiding medication

is not important to me

is a bit important to me

is very important to me

If you have answered that medication IS important to you, write down what medication you would like to cut down or avoid, and how much of it you are taking at the moment.

MYMOP2. Follow-up

Name.....

Today's date

Please circle the number to show how severe your problem has been IN THE LAST WEEK

This should be YOUR opinion, no-one else's !

SYMPTOM 1: 0 1 2 3 4 5 6
 As good as As bad as
 it could be It could be

SYMPTOM 2: 0 1 2 3 4 5 6
 As good as As bad as
 it could be It could be

ACTIVITY :..... 0 1 2 3 4 5 6
 As good as As bad as
 it could be It could be

WELLBEING : how 0 1 2 3 4 5 6
 would you rate your
 general feeling of
 wellbeing ? As good as As bad as
 it could be It could be

If an important new symptom has appeared please describe it and mark how bad it is below.

Otherwise do not use this line

SYMPTOM 3: 0 1 2 3 4 5 6
 As good as As bad as
 it could be It could be

The treatment you are receiving may not be the only thing affecting your problem. If there is anything else that you think is important, such as changes you have made yourself, or other things happening in your life, please write it here (write overleaf if you need more space):

If cutting down or avoiding medication is important to you , tick the box to show how this has changed since your previous MYMOP form:

- Not much change
- Taking less medication
- Taking more medication

If there has been a change write down what medication has changed, and how much of it you are taking now:

Appendix VIII

A COMPLETED MLA-164 APPLICATION FOR SUBMISSION TO THE MCA

FORM MLA 164 (Revised December 1995) MEDICINES ACT 1968
 NOTICE UNDER THE MEDICINES (EXEMPTION FROM LICENCES)
 (CLINICAL TRIALS) ORDER 1995 PART 1

1.	Product name or company code. NYR10																																				
2.	Full name and address of person submitting notification. John Rathbone, Neal's Yard Remedies, Ingate Place, Battersea, London, SW8 3NS																																				
3.	Name and address of supplier if different from 2. above. Company number if known.																																				
4.	Any other name under which the supplier carries on business. None																																				
5.	Does this CTX notification refer to a NEW ACTIVE SUBSTANCE	No																																			
6.	Is this a BIOLOGICAL SUBSTANCE?	Yes																																			
7.	Has your company made any other submission relating to active substance(s) mentioned in this notification?	No																																			
<p>If YES, please give NUMBERS (MA, CTX, CTC), DECISION (GRANTED, REFUSED, WITHDRAWN, PARAGRAPH 5 ACTION ETC.) and DATE</p> <table style="width: 100%; border-collapse: collapse;"> <thead> <tr> <th style="width: 15%;">MA/CTC/CTX</th> <th style="width: 15%;">CODE</th> <th style="width: 5%;"></th> <th style="width: 15%;">CODE</th> <th style="width: 5%;">LETTER</th> <th style="width: 25%;">DECISION</th> <th style="width: 20%;">DATE</th> </tr> </thead> <tbody> <tr> <td><input style="width: 100%;" type="text"/></td> <td><input style="width: 100%;" type="text"/></td> <td style="text-align: center;">/</td> <td><input style="width: 100%;" type="text"/></td> <td style="text-align: center;"><input type="checkbox"/></td> <td>.....</td> <td>.....</td> </tr> <tr> <td><input style="width: 100%;" type="text"/></td> <td><input style="width: 100%;" type="text"/></td> <td style="text-align: center;">/</td> <td><input style="width: 100%;" type="text"/></td> <td style="text-align: center;"><input type="checkbox"/></td> <td>.....</td> <td>.....</td> </tr> <tr> <td><input style="width: 100%;" type="text"/></td> <td><input style="width: 100%;" type="text"/></td> <td style="text-align: center;">/</td> <td><input style="width: 100%;" type="text"/></td> <td style="text-align: center;"><input type="checkbox"/></td> <td>.....</td> <td>.....</td> </tr> <tr> <td><input style="width: 100%;" type="text"/></td> <td><input style="width: 100%;" type="text"/></td> <td style="text-align: center;">/</td> <td><input style="width: 100%;" type="text"/></td> <td style="text-align: center;"><input type="checkbox"/></td> <td>.....</td> <td>.....</td> </tr> </tbody> </table>			MA/CTC/CTX	CODE		CODE	LETTER	DECISION	DATE	<input style="width: 100%;" type="text"/>	<input style="width: 100%;" type="text"/>	/	<input style="width: 100%;" type="text"/>	<input type="checkbox"/>	<input style="width: 100%;" type="text"/>	<input style="width: 100%;" type="text"/>	/	<input style="width: 100%;" type="text"/>	<input type="checkbox"/>	<input style="width: 100%;" type="text"/>	<input style="width: 100%;" type="text"/>	/	<input style="width: 100%;" type="text"/>	<input type="checkbox"/>	<input style="width: 100%;" type="text"/>	<input style="width: 100%;" type="text"/>	/	<input style="width: 100%;" type="text"/>	<input type="checkbox"/>
MA/CTC/CTX	CODE		CODE	LETTER	DECISION	DATE																															
<input style="width: 100%;" type="text"/>	<input style="width: 100%;" type="text"/>	/	<input style="width: 100%;" type="text"/>	<input type="checkbox"/>																															
<input style="width: 100%;" type="text"/>	<input style="width: 100%;" type="text"/>	/	<input style="width: 100%;" type="text"/>	<input type="checkbox"/>																															
<input style="width: 100%;" type="text"/>	<input style="width: 100%;" type="text"/>	/	<input style="width: 100%;" type="text"/>	<input type="checkbox"/>																															
<input style="width: 100%;" type="text"/>	<input style="width: 100%;" type="text"/>	/	<input style="width: 100%;" type="text"/>	<input type="checkbox"/>																															
8.	Scientific evidence page <ul style="list-style-type: none"> i. Pharmaceutical and biological ii. Non-clinical pharmacology and toxicology iii. Human studies Total (not to exceed 50-60 pages)																																				

*delete as appropriate

FORM MLA 164 (Revised December 1995)

(Official use only)

C	1																					
---	---	--	--	--	--	--	--	--	--	--	--	--	--	--	--	--	--	--	--	--	--	--

3. Active constituents: (1) (Official use only) Name		(2) Specification/ Reference	(3) Unit or Quantity/Dose	(4)
			% quantity	Unit
	<i>Hypericum perforatum</i>	ESCOP, 1997 EP, 2000	27.8	1.25g
	<i>Cimicifuga racemosa</i>	ESCOP, 2000 (in press) BHP, 1996 BHC, 1992	27.8	1.25g
	<i>Salvia officinalis</i>	ESCOP, 1997	16.7	0.75g
	<i>Dioscorea villosa</i>	BHP, 1996	16.7	0.75
	<i>Glycyrrhiza glabra</i>	BP, 1986, BHP, 1996	11.0	0.50g

Details of any overages: these should not be included in the formulation columns but stated in this section.

- 1) Please enter constituent(s) as actual substances included in the formulation, eg as salt and then as base equivalent where applicable.
- 2) **Specification reference:**
Where a specification does not refer to the latest published monograph, the relevant year should be included in the name column and not in the specification reference column. Where an ingredient has no official monograph please enter HSE in the Specification Reference column. Abbreviations to be used for specifications are: BP, EP, BPC, BNF, USP, NF, FRP, DAB, IP, NDP, JAP, PHV, BHP.
- 3) In the case of liquid preparations: all quantities for oral preparations should relate to a 5-ml dosage. Please state in dosage information any deviation from this rule. Quantity should be expressed as a percentage for other liquid preparations, including parenterals; please insert WW, WV etc. as appropriate in the Unit column. DO NOT INSERT a percentage sign.
- 4) The following abbreviations for units are recommended:-
ng - nanograms; µg - micrograms; mg - milligrams; g - grams; kg - kilograms; µl - microlitres; ml - millilitres; l - litres; U - units; KU - kilounits (1,000 U); MU - megaunits (1,000,000 U); IU - International Units; µCi - microcuries; Bq - becquerels.
- 5) Trailing zeros following the decimal point may be omitted.
- 6) Please photocopy page if more space for constituents is required.

Date:

FORM MLA 164 (Revised December 1995) (Official use only)

C	1																						
---	---	--	--	--	--	--	--	--	--	--	--	--	--	--	--	--	--	--	--	--	--	--	--

4. Anticipated clinical use:

The clinical use for the product NYR10 is to treat symptoms of the menopause, including vaso-motor disturbances (hot flushes and night sweats) insomnia, depression, nervousness, palpitations and cognitive problems.

- The age range of the patients for the clinical trial will be 45-65 years.
- The patients will be menopausal women who have not had a period for at least 6 months.
- The nature of the study will be a multicentre, placebo controlled, randomised, double-blinded trial.

The purpose of the trial is to evaluate whether the herbal formula NYR10 is significantly more effective than a placebo in alleviating menopausal symptoms and improving quality of life.

This will be determined using two questionnaires, the Women's Health Questionnaire (a menopause specific quality of life questionnaire) and the Measure Your Own Medical Outcomes Profile (MYMOP) questionnaire, a patient centred questionnaire.

(Official use only)

9	9	9	9
---	---	---	---

Date:

(Official use only)

B 1

--	--	--	--	--	--	--	--	--	--	--	--	--	--	--	--	--	--	--	--	--

5. Proposed dosage range and duration to be used for the trial and proposed route of administration:

The pharmaceutical form used will be a capsule containing dried powdered herbs. The route of administration will be oral. The maximum daily dosage will be 4.5g. The maximum proposed duration of exposure by patients will be 12 weeks.

The quantity of each herb per day is:

<i>Hypericum perforatum</i>	1.25 gram
<i>Cimicifuga racemosa</i>	1.25 gram
<i>Salvia officinalis</i>	0.75 gram
<i>Dioscorea villosa</i>	0.75 gram
<i>Glycyrrhiza glabra</i>	0.5 gram

Total: 4.5 g

The minimum age of the patient will be 45 years.

The maximum age of the patients will be 65 years.

The maximum number of patients in the clinical trial will be 400.

The placebo will be rice flour, administered orally via vegetable capsules.

The maximum daily dosage will be 4.5g.

The maximum proposed duration of exposure would be 12weeks.

Date:

(Official use only)

E	1																			
---	---	--	--	--	--	--	--	--	--	--	--	--	--	--	--	--	--	--	--	--

6. Other constituents:			Specification Quantity/Dose		
(Official use only)	Name		Reference	Unit or %quantity Unit	
	Vegetable capsule Farmacapsulas	Hydroxypropylmet- hylecellulose i.e. Carbohydrate gum derived from wood and cotton fibres	USP FCC GRAS	0.10 g	
	Rice flour to be used as the placebo			0.5g per capsule	

- 1) Please leave a line between different components of the dosage form, eg for capsule shell components, coating components.
- 2) Please complete modifier column marked MOD as follows:

 Insert TO if final volume cannot be expressed as a complete quantity.
 Insert ND for substances not detectable in the final formulation, eg solvents.
 Insert QS if quantity not fixed e.g. for substances used to adjust pH.
- 3) For notes on specification references, liquid preparations, abbreviations for units and decimals please refer to page 3.
- 4) Please photocopy page if more space for constituents is required.

Date:

(Official use only)

H	1																
---	---	--	--	--	--	--	--	--	--	--	--	--	--	--	--	--	--

7. Description of essential processes in the manufacture:

After harvesting, the herb material is dried to organic soil association standards by following standard operating procedures, which include using separate storage facilities from non-organic material.

The essential process comprises the grinding of herb material with an 8 inch Apex cutter mill with variable mesh sizes (1mm - 4mm). The raw ingredients are then mixed to the prescribed formula and encapsulated. Capsules are placed into tamper evident opaque sterile tubs and labelled /batched.

At all times during the manufacturing procedure, raw materials, bulk containers and major items of equipment are labelled with an indicator of the product material being processed and its batch number.

Each raw material is initially placed in a separate quarantine area and checked on delivery that the product complies with its specifications. Organoleptic checks are immediately carried out by the warehouse manager. All suppliers are required to supply certificates of analysis for starter materials and carry out their own laboratory testing in compliance with due diligence.

Raw ingredients are randomly sampled with a clean container and the sample sent off for external microbial and heavy metal analysis. Finished products are randomly sampled and analysed for microbial and heavy metal concentrations.

All fillers, encapsulators and mixers have to record the amount and weight of capsules and powders. These weights are checked during normal quality control procedures to ensure that they comply with the specification. Random checks are carried out to ensure that the mixers are accurately placing the correct quantity of raw ingredients into each formula.

The process validation protocol for G&G Food supplies Ltd requires that Good Manufacturing Practice is followed at all times. G&G is an affiliated company of the Institute of Quality Assurance and is certified by the Soil Association to manufacture organic products. G&G supplies has a class 'L' clean room facility for the manufacturing of all health food products, meeting the requirements of BS5295:1989.

8. Finished product specification:

0 size vegetable capsule containing total maximum weight 0.5g of herbal formula.

- | | |
|-----------------------------|-------|
| <i>Hypericum perforatum</i> | 27.8% |
| <i>Cimicifuga racemosa</i> | 27.8% |
| <i>Salvia officinalis</i> | 16.7% |
| <i>Dioscorea villosa</i> | 16.7% |
| <i>Glycyrrhiza glabra</i> | 11% |

Date:

(Official use only)

G 1

9. Type of container(s), pack size(s), shelf life and storage precautions.

The capsules will be stored in sterile plastic containers.
The pack size will be 100 capsules per container.
The containers will be opaque.

10. Assembler(s) G & G, Food supplies LTD, Vitality House, 2-3 Imberhome Way, East Grinstead, West Sussex RH19 1RL	11. Importer(s) into the UK The Organic Herb Trading Company Milverton, Somerset, TA4 1NF This Soil Association Standard affiliated company will be the supplier for all the herb material.
--	---

12. Name(s) of manufacturer(s) and site(s) of manufacture of:
(a) the active substance(s) and (b) the dosage form.

(a) The active substance(s) The Organic Herb Trading Company Milverton, Somerset, TA4 1NF	(b) The dosage form (including sterilisation if applicable) Manufacturing and filling/sterilisation: G & G, Food supplies LTD, Vitality House, 2-3 Imberhome Way, East Grinstead, West Sussex RH19 1RL
---	---

13. Site and arrangements for quality control, including arrangements for testing on import into UK if applicable.

Chemical, physical and biological testing is carried out by Microsearch Ltd: on behalf of
G & G, Food supplies LTD, Vitality House, 2-3 Imberhome Way, East Grinstead, West Sussex
RH19 1RL

Date:

PART IIB - TRIAL PROTOCOLS

1. Full details of the proposed trial, together with:

1.1 Protocol:

- 1.1.1 Title (and company reference number if applicable).
- 1.1.2 Nature of trial.
- 1.1.3 Aim of study.

1.1.1 Study into the effects of herbal medicine to alleviate symptoms of the menopause.

1.1.2 Placebo controlled, double-blind trial using herbal medicine to treat symptoms of the menopause.

1.1.3 The aim of the trial is to investigate the efficacy of a herbal formula (NYR10) in alleviating menopausal symptoms.

1.2 Duration of the trial:

- 1.2.1 Duration of active treatment. 12 weeks per patient
- 1.2.2 Overall duration of trial. 23 weeks

1.3 Proposed number of patients involved: 400

1.4 Criteria used in the selection of patients:

1.4.1 Inclusion criteria. Women with active menopausal symptoms (hot flushes and sweats); without a menstrual period for at least 6-months and aged between 45-65 years.

1.4.2 Exclusion criteria. Women currently taking HRT or women who have taken HRT in the last 2-months; pregnant women with a serious medical condition, (refer to Protocol for the clinical trial NYR10).

1.4.3 Withdrawal criteria. Any serious deterioration in the subjects health which would normally exclude patients from continuing with the active or placebo treatment. The practitioner on the initial and follow-up consultations will assess this.

1.5 Description of the safety monitoring procedures:

Dr Ellis Snitcher will oversee safety procedures for the duration of the trial and will monitor patient welfare. Patients will be interviewed by qualified herbal medicine practitioners who are members of the professional body, The National Institute of Medical Herbalist. The practitioner will screen for any serious health conditions at the initial consultation by performing a multisystem check (cardiovascular system, respiratory system, gastrointestinal system, urogenital system, nervous system and gynaecological system). The patients' medical/drug history will be sought, providing a screen on their previous and current health. Further monitoring will continue at all follow-up appointments.

Date:

Table of contents

Part I- Introduction, background and rationale for trial	23
Part II -Pharmaceutical data	
A Composition	23
1. Complete composition	23
2. Overage	23
3. Container	23
4. Formulations used in reported clinical trials	23
5. Developmental pharmaceuticals	23
B Method of Preparation	23
1. Manufacturing formula	24
2. Manufacturing process in-process controls	24
3. Validation	24
C Control of Starting Material	24
1. Active ingredients	24
1.1 Specification and routine tests	24
1.1.1 Active ingredients described in a pharmacopoeia	25
1.1.2 Active ingredients not described in a pharmacopoeia	25
Vegetable drug Monograph	26
<i>Hypericum perforatum</i>	26-7
<i>Cimicifuga racemosa</i>	28-9
<i>Salvia officinalis</i>	30-31
<i>Dioscorea villosa</i>	32-33
<i>Glycyrrhiza glabra</i>	34-35
1.3 Scientific data- vegetable drugs	36
1.3.1 Nomenclature	36
1.3.1 Description of main constituents	36-37
1.3.3 Manufacture	37
1.3.4 Development for active ingredient of vegetable origin	38
<i>Hypericum perforatum</i>	38-39
<i>Cimicifuga racemosa</i>	39
<i>Salvia officinalis</i>	39
<i>Dioscorea villosa</i>	39
<i>Glycyrrhiza glabra</i>	39
1.3.5 Impurities	40
1.3.6 Batch Analysis	40
2. Other ingredients	40
2.1 Specification and routine tests	40
2.1.1 Ingredients described in a pharmacopoeia	40
2.1.2 Ingredients not described in a pharmacopoeia	40
2.2 Scientific data	40
3. Packaging material (immediate packaging)	40
D Control tests on intermediate products (if necessary)	40
E Control tests on finished product	40
1.1 Product specs. & tests for release at time of manufacture	41
2. Scientific data	41

2.1 Analytical validation of methods	41
2.2 Batch analysis	41
F Stability	
1. Stability tests on active ingredients	41
2. Stability tests on the finished product	42
Q. Other information	42
Part III- Experimental and biological studies: <i>Hypericum perforatum</i>	
A Non-clinical pharmacology and toxicology studies	
1. Pharmacology	43
1.1 Action relevant to the proposed therapeutic use	43
Pharmacological studies in humans	43
1.2 Other actions sought	43
1.3 Drug interactions	43-44
2. Pharmacokinetics	44
3. Single and repeat dose toxicity studies	44
4. Mutagenicity	44
5. Carcinogenicity	44
6. Reproductive toxicology	44
7. Other information	44
Non-clinical pharmacological/toxicological studies	44
B: Clinical Data and Previous Human Experience	
1. Human Pharmacology	45
2. Human Pharmacokinetics	45
3. Normal volunteer studies	45
4. Patient studies	45
5. Post market surveillance	45
6. Extensive previous human use	45
Experimental and biological studies: <i>Cimicifuga racemosa</i>	
A Non-clinical pharmacology and toxicology studies	
1. Pharmacology	46-48
1.1 Action relevant to the proposed therapeutic use	46-48
Pharmacological studies in humans	
1.2 Other actions sought	48
1.3 Drug interactions	48
2. Pharmacokinetics	48
3. Single and repeat dose toxicity studies	48-49
4. Mutagenicity	49
5. Carcinogenicity	49
6. Reproductive toxicology	49
7. Other information	49
8. Presentation of non-clinical pharmacological/toxicological studies	49
B: Clinical Data and Previous Human Experience	
1. Human Pharmacology	49
2. Human Pharmacokinetics	49
3. Normal volunteer studies	49
4. Patient studies	49
5. Post market surveillance	49
6. Extensive previous human use	49

Experimental and biological studies:	<i>Salvia officinalis</i>	
A	Non-clinical pharmacology and toxicology studies	
1.	Pharmacology	50
1.1	Action relevant to the proposed therapeutic use	50
	Pharmacological studies in humans	
1.2	Other actions sought	50
1.3	Drug interactions	50
2.	Pharmacokinetics	50
3.	Single and repeat dose toxicity studies	50
4.	Mutagenicity	50
5.	Carcinogenicity	50
6.	Reproductive toxicology	50
7.	Other information	50
8.	Non-clinical pharmacological/toxicological studies	50
B:	Clinical Data and Previous Human Experience	
1.	Human Pharmacology	50
2.	Human Pharmacokinetics	50
3.	Normal volunteer studies	50
4.	Patient studies	50
5.	Post market surveillance	50
6.	Extensive previous human use	50
Experimental and biological studies:	<i>Dioscorea villosa</i>	
A	Non-clinical pharmacology and toxicology studies	
1.	Pharmacology	51
1.1	Action relevant to the proposed therapeutic use	51
	Pharmacological studies in humans	
1.2	Other actions sought	51
1.3	Drug interactions	51
2.	Pharmacokinetics	51
3.	Single and repeat dose toxicity studies	51
4.	Mutagenicity	51
5.	Carcinogenicity	51
6.	Reproductive toxicology	51
7.	Other information	51
8.	Non-clinical pharmacological/toxicological studies	51
B:	Clinical Data and Previous Human Experience	
1.	Human Pharmacology	51
2.	Human Pharmacokinetics	51
3.	Normal volunteer studies	51
4.	Patient studies	51
5.	Post market surveillance	51
6.	Extensive previous human use	51
Experimental and biological studies:	<i>Glycyrrhiza glabra</i>	
A:	Non-clinical pharmacology and toxicology studies	
1.	Pharmacology	52
1.1	Action relevant to the proposed therapeutic use	52
	Pharmacological studies in humans	
1.2	Other actions sought	52
1.3	Drug interactions	52
2.	Pharmacokinetics	52-53
3.	Single and repeat dose toxicity studies	53-54
4.	Mutagenicity	54
5.	Carcinogenicity	54
6.	Reproductive toxicology	54

7. Other information	54
8. Non-clinical pharmacological/toxicological studies	54
B: Clinical Data and Previous Human Experience	54
1. Human Pharmacology	54
2. Human Pharmacokinetics	54
3. Normal volunteer studies	54
4. Patient studies	54
5. Post market surveillance	54
6. Extensive previous human use	54

Part I

Introduction, background and rationale for trial:

The clinical use for the product NYR10 is to treat symptoms of the menopause, including vaso-motor disturbances (hot flushes and night sweats) insomnia, depression, nervousness, palpitations and cognitive problems. A multicentre, placebo controlled, randomised, double-blind trial is proposed to evaluate the effectiveness of a herbal formula (NYR10) in alleviating menopausal symptoms and improving quality of life. This will be determined using two questionnaires, the Women's Health Questionnaire (a menopause specific quality of life questionnaire) and the MYMOP questionnaire (a patient centred questionnaire).

Part II Pharmaceutical and Biological Data

A: Composition

1. Complete composition:

Name of Ingredients	Active Ingredients	Other Ingredients	Unit and/or % formula	Function	Reference to standards
<i>Hypericum perforatum</i> L.	<i>Hypericum perforatum</i>	Hypericin, Hyperforin Flavonoids	Solid oral forms 27.8%	Antidepressant Anti-viral	EP, 2001 ESCOP, 1997
<i>Cimicifuga racemosa</i> L.	<i>Cimicifuga racemosa</i>	27-deoxyacetin Acetin, Cimigenol, Caffeic acid	Solid oral forms 27.8%	Treatment of climacteric symptoms	ESCOP, 2000 (in press) BHP, 1996 BHP, 1992
<i>Salvia officinalis</i> L.	<i>Salvia officinalis</i>	Essential oils- alpha and beta thujone Carnosic acid, Rosmarinic acid	Solid oral forms 16.7%	Antihydrotic Oestrogenic	ESCOP, 1997
<i>Dioscorea villosa</i> L.	<i>Dioscorea villosa</i>	Dioscine Starch	Solid oral forms 16.7%	Oestrogenic Anti-inflammatory	BHP, 1996
<i>Glycyrrhiza glabra</i> L.	<i>Glycyrrhiza glabra</i>	Glycyrrhizin and its aglycone glycyrrhetic acid	Solid oral forms 11%	Oestrogenic Anti-inflammatory	BP, 1986 BHP, 1996 BHC, 1992
Vegetable Capsule	N/A	Hydroxypropyl-Methylecellulose. Carbohydrate gum derived from wood and cotton fibre	N/A	Encapsulation	USP FCC GRAS

Herb	Final composition/Amount per capsule	Daily dosage
<i>Hypericum perforatum</i> L.	0.138g	1.25g
<i>Cimicifuga racemosa</i> L.	0.138g	1.25g
<i>Salvia officinalis</i> L.	0.083g	0.75g
<i>Dioscorea villosa</i> L.	0.083g	0.75g
<i>Glycyrrhiza glabra</i> L.	0.055g	0.5g

2. Overage: N/A

3. Container:

The capsules will be stored in sterile plastic containers (DUMA, PEHD). The pack size will be 100 capsules per container. The containers will be opaque.

4. Formulations used in reported clinical trials and /or bioavailability studies:

No previous trials or bioavailability data have been performed for this *formula*.

5. Developmental Pharmaceutics:

The individual herbs in this formulation are in accordance with uses indicated by herbal pharmacopoeias for menopausal complaints. The container to be used is opaque to minimise photo-oxidation.

The formulation is based on the traditional and current practice of medical herbalists. Typically, 4-6 herbs are used in combination to treat conditions such as menopausal complaints. The rationale for the selection of individual herbs and the formulation in particular are as follows:

Hypericum perforatum

Extensive clinical research identifying safety and efficacy as an anti-depressant, with some anoxylitic activity. Also indications in sleep quality (see data in part III Experimental and biological studies).

Key active constituents- Hypericin and hyperforin

Cimicifuga racemosa

Moderately researched as a single herb. Current evidence supports its use in the treatment of climacteric symptoms such as hot flushing; limited research in combination with *Hypericum perforatum* suggests efficacy as a combination in climacteric symptoms, including mood changes. In vitro work suggests that *Cimicifuga racemosa* may have oestrogenic activity (see data in part III Experimental and biological studies).

Key active constituents: 27-deoxyacetin

Salvia officinalis

Limited clinical research suggests the potential use of this herb for excessive sweating in menopause. The usage relates to long established use as a antihydrotic. The herb appears to be oestrogenic in vitro (see data in part III Experimental and biological studies).

Key active constituents: essential oils- alpha and beta thujone

Dioscorea villosa

Almost no clinical research has been carried out on this herb which has a limited traditional use during menopause. The oestrogenic activity of *Dioscorea villosa* has been established and shown to be due to the action of steroidal saponins.

Key active constituents: Dioscine

Glycyrrhiza glabra

There has been detailed research into this herb's anti-inflammatory and adreno-cortical activity. Longstanding traditional use in relief of menopausal symptoms (see data in part III Experimental and biological studies).

Key active constituents: Glycyrrhizin and its aglycone glycyrrhetic acid.

B: Method of Preparation

1. Manufacturing formula:

The batch size will be 31kg, which translates for each individual herb to *Hypericum perforatum* 8.5kg, *Cimicifuga racemosa* 8.5kg, *Salvia officinalis*, 5.5kg *Dioscorea villosa* 5.5 and 3.0kg of *Glycyrrhiza glabra*, to provide 60,000 capsules of the active treatment. Each container to hold 100 capsules. No substances will be removed in the manufacturing process. No excipients will be used in the manufacturing process.

Manufacturing formula:

Herb	Percentage composition	Batch starting material (Kg)
<i>Hypericum perforatum</i>	27.8%	8.5
<i>Cimicifuga racemosa</i>	27.8%	8.5
<i>Salvia officinalis</i>	16.7%	5.5
<i>Dioscorea villosa</i>	16.7%	5.5
<i>Glycyrrhiza glabra</i>	11%	3.0

2. Manufacturing process, in-process controls and assembly process:

The essential process comprises the grinding of herb material with an 8" Apex cutter mill with variable mesh sizes between 1mm & 4mm. Then the raw ingredients are mixed to a prescribed recipe and encapsulated. Capsules are filled to the required amount into tamper evident opaque tubs and labelled /batched. At all times during the manufacturing procedure, all raw materials, bulk containers and major items of equipment are labelled with an indicator of the product material being processed with its batch number. Each raw material is initially placed in a separate quarantine area and checked on delivery that the product complies with its specifications. The warehouse manager immediately carries out organoleptic checks. All suppliers are required to supply certificates of analysis for starter materials and carry out their own laboratory testing in compliance with due diligence. Cleaning procedures for the equipment and manufacturing areas are conducted in accordance with written specifications and procedures. Cleaning schedules for each area of the premises are in existence. The effectiveness of cleaning is microbiologically evaluated using damp swabs to wipe down all surfaces. The swabs are then analysed.

All materials are recorded with product and supplier's name, batch number and date of receipt. The batch number is used to identify the product in storage and processing. It is recorded at every stage of manufacture in order to ensure that any batch of finished product can be correlated with the deliveries of the respective raw materials used in its manufacture and with any corresponding laboratory records. Records are kept for all batches. All retained records permit full batch traceability from the customer through the factory back to the supplier of the individual raw ingredients.

Raw ingredients are randomly sampled for external microbial and heavy metal analysis. Finished products are randomly sampled and analysed for microbial and heavy metal concentrations. All fillers, encapsulators and mixers have to record the amount and weight of capsules and powders. These weights are checked during quality control to ensure that they comply with the specification. Random checks are carried out to ensure that the mixers are accurately placing the correct quantity of raw ingredients into each formula. The process validation protocol for G&G Food supplies Ltd requires that GMP be followed at all times. G&G are an affiliated company of the Institute of Quality Assurance and are certified by the Soil Association to manufacture organic products. G&G supplies has a class 'L' clean room facility for the manufacturing of all health food products, meeting the requirements of (BS5295:1989).

3. Validation of the process

G & G Food Supplies Ltd, perform routine random checks with the mixing/encapsulating machinery to ensure the composition is uniform. All packaging machinery is calibrated annually or more frequently if required and calibration records kept for referral. An external contracted company calibrates all scales on an annual basis. Internal scale calibration tests are carried out on an annual basis by the quality control department.

C: Control of starting material

1. Active ingredients

Herb	Active ingredients
<i>Hypericum perforatum</i>	Hypericin, hyperforin
<i>Cimicifuga racemosa</i>	27-deoxyacetin
<i>Salvia officinalis</i>	Essential oil, alpha and beta thujone
<i>Dioscorea villosa</i>	Dioscine
<i>Glycyrrhiza glabra</i>	Glycyrrhizin and its aglycone glycyrrhetic acid,

1.1 Specification and routine tests:

All herbs will be examined macroscopically and microscopically to ensure correct identification of the herb material. Ash value will be measured against pharmacopoeia values to ensure conformity. The starting material will be sent to a UCAS accredited public analyst for confirmation of correct identity of the herb(s) material and testing according to British Herbal Compendium specifications.

1.1.1 Active ingredients described in a pharmacopoeia:

The material used for the trial will be plant/herb material and is not 'manufactured' from a new source. The herb material will be obtained from organically grown crops. Herbal medicine principally uses the whole plant, which contains many constituents. As no manufacturing process is used no chemical synthesis and no synthetic impurities will occur.

The herb material will be inspected to ensure that they comply with the herbal monograph that is macroscopic and microscopic examination, TLC, HPLC and total viable count to ensure correct identification and compliance with the biological load for herb material.

Total viable aerobic count: Not more than 1,000,000 aerobic bacteria
 Not more than 100,000 fungi per g
 Absence of *Escherichia coli* per g
 Absence of *Salmonella* per 10.0 g

1.1.2 Active ingredients not described in a pharmacopoeia:

- Assay(s) and/or other evaluation of potency- The action of the whole plant(s) is being investigated and no assumptions is been made for 'active ingredients'. Specifications will be provided to G&G to ensure the formulation criteria are followed to GMP.
- Characteristics/Description- N/A
- Identification tests -Thin layer chromatography and fingerprinting of the chemical composition will be performed.
- Physical and chemical purity tests including limits for named, total, other single, unidentified total impurities- Loss on drying and ash values will be performed.
- Potential contamination by microorganism, pesticides, toxic metals, radioactivity, fumigants etc- Total viable count and heavy metal analysis will be performed for the herbs. Organic certification for the growers states that no fumigants or pesticides are to be used.
- Assay(s) of constituents of vegetable drugs or vegetable drug preparations with known therapeutic activity- HPLC/ TLC chromatograms will be used to provide a fingerprint analysis of the herb material.
- A monograph of the vegetable drug (see pages 26-36)

Vegetable Drug Monograph

Botanical name: *Hypericum perforatum* L.

Common name: St. John's wort

Hypericum perforatum foliage

Definition:

Hypericum consists of the dried aerial parts of *Hypericum perforatum* L. (Fam. Hypericaceae) gathered during the flowering periods or shortly before. The plant is a native British herb up to 90 cm tall, upright, branching with opposite, oblong, entire, sessile leaves exhibiting numerous pellucid dots and bearing heads of bright yellow five-petalled flowers with numerous stamens (BHP, 1996). There are approximately 370 species in the genus *Hypericum* (Mabberley, 1987). *Hypericum perforatum* is native to all of Europe and Asia except for the Arctic regions.

Physical characteristics:

Macroscopical:

Both petals and leaves are characterised by numerous, punctate glands approximately 0.5-1mm in diameter. These can be readily observed with a 10X hand lens. The leaf glands appear translucent when held against light. Those on the petals appear as black dots along the margins.

Stems: Cylindrical with two equidistant longitudinal ridges base brown and woody with hollow centre, upper portion green and branched to form a terminal cyme. Stem pieces are cylindrical, hollow, faintly two-ribbed on opposite sides, pale green (BHP, 1996).

Leaves: Mainly green fragments of the glabrous leaves containing oil glands as a transparent areas, with some small black 'dots' on the lower surfaces. Opposite, sessile pairs; grey-green, linear oblong, 8-30mm in length, entire margin revolute when dried, obtuse apex, base even. Surface glabrous but exhibiting brown 'dots', on heating with chloral hydrate solution those in central areas become translucent but in marginal positions reveal red pigments (BHP, 1996).

Flowers: Groups of flower buds with yellow petals enclosed by lanceolate green sepals, all finely black dotted 2cm in diameter; five green lanceolate sepals, acuminate apex, joined at base, surface with brown 'dots'; five yellow linear-ovate petals, longer than sepals, dark 'dots' on terminal margins only; numerous stamens with long filaments and anthers, with single, terminal pigment dot; ovary elongated and conical with parietal placentation, containing numerous brown triangular seeds with one rounded surface (BHP, 1996).

Microscopical:

Leaf epidermal cells with sinuous anticlinal walls, those of the upper surface being beaded. Stomata anomocytic, in the lower epidermis only. Trichomes and calcium oxalate crystals absent. The mesophyll contains clear schizogenous oil glands and dark hypericin glands which yield a red pigment, especially at the leaf margins and on the flower parts, including the anthers. Pollen grains ellipsoidal, with smooth exine

and 3 pores, about 20-25 μm in diameter (BHP, 1996).

Odour: Distinct, slightly sweet and aromatic, somewhat balsamic.

Taste: Slightly sweet, mildly bitter, somewhat resinous and astringent

Total Ash: Not more than 8%

Acid insoluble ash: Not more than 2.5%

Traditional uses: Mild to moderate depressive states, anxiety insomnia (BHP, 1996)

Key constituents:

It contains not less than 0.04 per cent of naphthodianthrones of the hypericin group (so called total hypericin) calculated as hypericin. Characteristic constituents are the naphthodianthrones (usually 0.1-0.15%) mainly hypericin and pseudohypericin. Lower levels than 0.1% may result from harvesting of lower parts of the herb. Another group of constituents consists of flavones and flavonols (2-4%) mainly quercetin glycosides including hyperoside (0.7%) quercitrin, isoquercitrin and rutin (0.3% each); also the aglycones quercetin, kaempferol, luteolin and myricetin. Biflavonoids, such as 3',8''-biapigenin and 3',8''biapigenin (0.01-0.5%) are mainly present in the flowers. Phloroglucinol derivatives, principally hyperforin (2-4%) which is unstable (Escop, 1997).

Vegetable Drug Monograph

Botanical name: *Cimicifuga racemosa* L.

Common name: Black cohosh, Black snakeroot

Definition: *Cimicifuga* consists of the dried rhizome and roots of *Cimicifuga racemosa* (Fam. Ranunculaceae) a perennial herb indigenous to Canada and the USA. It is collected in the autumn (BHP, 1996).

Physical characteristics

Macroscopical:

Rhizome Dark brown externally, hard, subcylindrical and somewhat knotted, 1-2 cm in diameter and 5-15cm long. Has several stout ascending branches marked with encircling leaf scars terminating in a cup shaped scar. Undersurface has attached long brittle roots sometimes broken or represented as root scars. Fractures horny, internally dark brown and waxy, or sometimes white. Exhibits a thin dark bark, a distinct cambium line and a radiate xylem 4-5mm thick consisting of pale wedges separated by darker medullary rays; pith 3-5 mm in diameter. The *root* is quadrangular, dark brown externally and longitudinally wrinkled, fracture short, internally dark brown and exhibiting a 4-rayed xylem. Odourless; taste bitter and acrid (BHP, 1996).

Microscopical:

Light to dark brown powder; starch grains numerous, simple or compound, individual grains 3-15µm in diameter, spheroidal with a central cleft, fragments of lignified vessels with scalariform thickening or bordered pits. Heavily lignified xylem fibres, thin walled; irregular yellow brown fragments of suberised epidermal cells, sometimes elongated, with thickened walls (BHP, 1996).

Total Ash: Not more than 10%

Acid insoluble ash: Not more than 4%

Key constituents:

Triterpene glycosides:

The constituents of *Cimicifuga racemosa* are not completely known. However, the triterpene glycosides are considered the main active constituents (Liske, 1998). *Cimicifuga racemosa* contains principally: Xylosides: actein (aglycone: acetylacteol) and cimicifugoside (aglycone: cimigenol) also called cimigoside, deoxyacetylacteol and 27-deoxyacetin (Leung & Foster 1996; Schaper & Brummer 1997). Three novel cyclolanostanol xylosides were recently isolated: cimicifugosides H-1, H-2, and H-5. All of these constituents contain a cyclopropane and are structurally related to cycloartenol (Koeda *et al*, 1995).

Isoflavones:

Formononetin has been isolated previously, but more recent studies of the commercial preparation, Remifemin, failed to show its presence in the isopropyl/ethanolic aqueous extract (Struck *et al*. 1997).

Alkaloids:

N-methylcytisine, and related unknown quinolizidine alkaloids, have been reported (Newall *et al.* 1996) as have phenolic acids: Isoferulic and salicylic acids (Leung & Foster, 1996).

Other Constituents:

Include tannin, resins cimicifugin = macrotin, volatile oils, palmitic, gallic, butyric, and oleic acids, starches and sucrose (Duke 1985). Newall *et al.* (1996) further quantifies cimicifugin (15-20%), described as a resinous mixture containing racemosin, and other unspecified phytosterols, as well as acetic acid, caffeic acid and actein.

Vegetable Drug Monograph

Botanical name: *Salvia officinalis* L.

Common name: Sage

Salvia officinalis leaves

Definition:

Salvia consists of the dried herb *Salvia officinalis* (Fam. Labiatae) (Escop, 1997). A perennial herb growing up to 50cm in height. *Salvia* is indigenous to Southern Europe and the USA (BHP, 1996).

Macroscopical:

Leaves oblong-lanceolate or ovate, 2-10 cm long and 1-2.5cm broad; apex acute, base rounded to somewhat cordate, frequently lobed; margin crenulate; upper surface grey-green and pubescent when young, nearly smooth with a depressed midrib and veins when older; lower surface light green, prominent midrib, minutely reticulate and densely pubescent. Petiole up to about 4 cm long, on the upper surface, greenish-grey to purplish, densely pubescent (BHP, 1996).

Microscopical:

Dark green powder; epidermal fragments polygonal and thick-walled, stomata caryophyllaceous; covering trichomes long narrow, uniseriate, 2-6 celled with thick walls and sharply acute apices; glandular trichomes of two types, 1-4 celled stalk and a mono or bicellular head, sessile rosette-shaped trichomes with 6-8 encapsulated cells (BHP, 1996).

Odour: Aromatic

Taste: Aromatic and bitter

Total: Ash: not more than 8%

Traditional uses: Hyperhidrosis, pharyngitis

Key constituents:

Essential oil, up to 2.5% containing monoterpenoids such as alpha and beta thujone (up to 60% and 10% respectively) camphor and cineole.

Monoterpenoid glycosides. Diterpenoids: abietanes such as carnosic acid and its derivatives e.g. carnosol.

Triterpenoids: oleanolic acid.

Flavonoids, 5-methoxysalvigenin

Phenolic compounds, rosmarinic acid (Escop, 1997).

Rosmanol, epirosmanol, carnosol, rosmadial, carnosic acid, methyl carnosate, salvianolic acid and sagerinic acid (Yinrong, 1999; Cuvelier, 1994).

Vegetable Drug Monograph

Botanical name: *Dioscorea villosa* L.

Common name: Wild Yam

Definition:

Dioscorea consists of the dried underground parts of the *Dioscorea villosa* (Fam. Dioscoreaceae). The plant is common in eastern and central United States and is a herbaceous twining perennial. *Dioscorea* contains steroidal glycosides including dioscine and starch (BHP, 1983).

Physical Characteristics:

Macroscopical:

Irregular yellow hard woody chips of rhizome, up to 3x 1 cm often with cork missing exposing brown exterior. Fine strands of brown fibrous roots present. Pale cream inner surface with small scattered yellow areas. (BHP, 1983).

Microscopical

Powder, yellow brown. Abundant simple spherical or ovoid starch grains up to 30 μm in diameter. Numerous, fragments of lignified parenchyma with thick walls containing slit-like pits. Groups of lignified tracheids with small bordered pits. Occasional groups of fibres with narrow lumen and pitted lignified walls. Few pieces of thin walled brown cork cells. A few calcium oxalate needles (BHP, 1983).

Total Ash: not more than 7%

Acid insoluble ash: not more than 2%

Traditional uses: Dysmenorrhoea

Taste: bitter, starchy and persistently acrid

Key constituents: Saponins- Dioscine

Vegetable Drug Monograph

Botanical name: *Glycyrrhiza glabra* L.

Common name: Licorice

Glycyrrhiza glabra foliage

Definitions:

Glycyrrhiza is the dried root and stolon of *Glycyrrhiza glabra* L. (Fam. Leguminosae), a tall erect herbaceous perennial distributed over Southern Europe. It is obtained mainly from Turkey, Russia, Syria and Iran (BHP, 1983).

Macroscopical:

Nearly cylindrical tapering pieces of root 15-20cm long, 0.5-3 cm in diameter. Externally brown traces of lateral roots; cork coarsely fibrous, longitudinally striated; inner surface where exposed, white to yellow and fibrous. Stolons cylindrical, 1-2 cm in diameter and may be up to several metres in length. Fractures of both root and stolon fibrous and granular. Transverse section shows thin cork, wide, yellow secondary phloem, cylindrical yellow xylem with a radiate structure. Stolon exhibits central pith. (BHP, 1983).

Glycyrrhiza glabra root

Microscopical:

Light yellow powder; starch grains numerous, mainly single, ovoid to ellipsoidal 2-20µm in diameter; fragments of large oval medullary ray cells; phloem fibres lignified, long, occur single or in groups, frequently surrounded by a layer of parenchyma cells, each containing a single prism of calcium oxalate, 10-25µm wide; large vessel walls with closely arranged bordered pits, often associated with lignified parenchyma; red brown cork fragments, cells polyhedral and tabular (BHP, 1983).

Total ash: not more than 10%

Odour: characteristic

Taste: Sweet and faintly astringent

Acid insoluble ash: not more than 2%

Traditional uses: Gastric or duodenal ulcer, anti-inflammatory, expectorant (BHP, 1996)

Key constituents: Saponins- Glycyrrhizin and its aglycone glycyrrhetic acid
Flavonoids: glucoliquiritin apioside, prenyllicoflavone, shinflavanone, shinpterocarpin and 1-methoxyphaseollin

1.3 Scientific data vegetable drugs

1.3.1. Nomenclature

Scientific name	Variety	Chemotype	Part used	Preparation
<i>Hypericum perforatum</i> L.	Not Known	Not Known	Aerial	Dried & powdered
<i>Cimicifuga racemosa</i> L.	Not Known	Not Known	Root	Dried & powdered
<i>Salvia officinalis</i> L.	Not Known	Not Known	Leaves	Dried & powdered
<i>Dioscorea villosa</i> L.	Not Known	Not Known	Root	Dried & powdered
<i>Glycyrrhiza glabra</i> L.	Not Known	Not Known	Root	Dried & powdered

1.3.2 Description of Main constituents

Hypericum perforatum

Naphthodianthrones

Characteristic constituents are the naphthodianthrones (usually 0.1-0.15%) mainly hypericin and pseudohypericin. Levels lower than 0.1% may result from harvesting of lower parts of the herb. The naphthodianthrones include hypericin, pseudohypericin, isohypericin and emodin-anthrone. In the fresh plant material, protohypericin and protopseudohypericin are also present. These biosynthetic precursors are transformed into hypericin and pseudohypericin by exposure to light (Escop, 1997).

Flavonoids

The proanthocyanidins, consisting of dimers, trimers, tetramers and high polymer of catechin and epicatechin represent approximately 12% of the dried weight of the aerial portion of the plant.

The following flavonols have also been identified: kaempferol, luteolin, myricetin, quercetin; flavonol glycosides, quercitrin, isoquercitrin, hyperin/hyperoside, 13,II8-biapigenin and rutin.

Phloroglucinols: Hyperforin.

Other compounds: Choline, pectin, cysteine, GABA and tannins.

Cimicifuga racemosa

Triterpene glycosides

The constituents of *Cimicifuga racemosa* are not completely known however the triterpene glycosides are considered the main active constituents (Liske, 1998). *Cimicifuga racemosa* contains principally: Xylosides: acteïn (aglycone: acetylacteol) and cimicifugoside (aglycone: cimigenol) also called cimigoside, deoxyacetylacteol and 27-deoxyacetin (Leung & Foster 1996; Schaper & Brummer, 1997).

Three novel cyclolanostanol xylosides were recently isolated: cimicifugosides H-1(1), H-3(2), and H-4(3). All of these constituents contain a cyclopropane ring as a common structural feature, and are structurally related to cycloartenol (Koeda *et al.* 1994).

Isoflavones

Formononetin was previously isolated, but more recent studies of the commercial preparation, Remifemin, failed to show its presence in the isopropyl/ethanolic aqueous extract (Struck *et al.* 1997).

Alkaloids:

N-methylcytisine, and related unknown quinolizidine alkaloids, have been reported (Newall *et al.* 1996).

Phenolic Acids:

Isoferulic and salicylic acids are reported in *Cimicifuga racemosa* (Leung & Foster 1996).

Other Constituents:

Include tannin, resins cimicifugin = macrotin), volatile oils, palmitic, gallic, butyric, and oleic acids, starches and sucrose (Duke 1985). Newall *et al.* (1996) further quantifies cimicifugin (15-20%), described as a resinous mixture containing racemosin, and other unspecified phytosterols, as well as acetic acid, caffeic acid, acetin, and cimigenol.

Salvia officinalis

Essential oil, up to 2.5% containing monoterpenoids such as alpha and beta thujone (up to 60% and 10% respectively) camphor and cineole. Monoterpenoid glycosides. Diterpenoids: abietanes such as carnosic acid and its derivatives, for example, carnosol. Triterpenoids: oleanolic acid. Flavonoids. Rosmarinic acid (Escop, 1997).

Dioscorea villosa

Saponins- Dioscine.

Glycyrrhiza glabra

Saponins- Glycyrrhizin and its aglycone glycyrrhetic acid.

Flavonoids: glucoliquiritin apioside, prenyllicoflavone, shinflavanone, shinpterocarpin and 1-methoxyphaseollin.

1.3.3 Manufacture

- Geographical source of vegetable drug- Europe.
The Soil Association Certification scheme is a certification scheme for licensing organic food production. It involves the independent inspection and certification of organic food from its production through the processing and distribution chain. The certification scheme is registered with the United Kingdom Register of Organic Food Standards (UKROFS) and is licensed to certify organic food production and processing under European Commission Regulation No 2092/91. All herb material will be identified from its country of origin. The herb material will be organically produced to the standards of the Soil Association or their equivalent.

The criteria for organic certification are:

- Organic production must take place on clearly defined units of land such that the production and storage areas are clearly separate from those of any other unit not producing in accordance with these standards.
- The avoidance of fertilisers in the form of soluble mineral salts.
- The prohibition of agro-chemical pesticides.
- Prohibition of synthetic pesticides
- Heavy metals in manure should not exceed the levels specified for manures.
- Sewage sludge, effluents and sludge based composts are prohibited.
- Seed dressing based on mercurial and organo-chlorine compounds (including gamma HCH, lindane and BHC) are prohibited.
- No pesticides used.
- Herbs grown on uncontaminated soil.
- Herbs to be grown away from crops produced using pesticides.
- Organic herb material to be stored separately from non-organic herbs.
- Harvesting to take place when the plants are at their best possible quality.
- Equipment is to be cleaned and in technically perfect working order.
- The use of ionising radiation and synthetic chemicals as an aid to preservation is prohibited.

Processing steps e.g. Drying, comminuting, extraction:

Drying equipment, including conveyors and other ancillary equipment, are to be clean, free from non-organic crop residues and any other materials that may contaminate the produce.

Harvesting and storage:

Harvesting equipment, including vehicles and containers used for transporting the produce are clean, free from non-organic crop residues and any other materials which may contaminate the produce.

1.3.4 Development for active ingredient of vegetable origin

- Description of the vegetable drug (macroscopic and microscopic).
- Composition and analytical research for constituents and physical characteristics.
- Investigation for adulterants or known toxic constituents.
- Analytical development and validation. Commentary on the choice of routine tests and specifications.

Hypericum perforatum

Macroscopical:

Mainly green fragments of the glabrous leaves containing oil glands as a transparent areas, with some small black dots on the lower surfaces. Groups of flower buds with yellow petals enclosed by lanceolate green sepals, all finely black dotted. Stem pieces cylindrical, hollow, faintly two-ribbed on opposite sides, pale green (BHP, 1996).

Stems: Cylindrical with two equidistant longitudinal ridges, base brown and woody with hollow centre, upper portion green and brown to form a terminal cyme (BHP, 1996).

Leaves: Opposite, sessile pairs; grey-green, linear oblong, 80-30mm in length, entire margin revolute when dried, obtuse apex, base even. Surface glabrous but exhibiting brown dots, on heating with chloral hydrate solution those in central areas become translucent but in marginal positions reveal red pigments (BHP, 1996).

Flowers: 2cm in diameter; five green lanceolate sepals, acuminate apex, joined at base, surface with brown dot; five yellow linear-ovate petals, longer than sepals, dark dots on terminal margins only; numerous stamens with long filaments and anthers, with single, terminal pigment dot; ovary elongated and conical with parietal placentation, containing numerous brown triangular seeds with one rounded surface (BHP, 1996).

Microscopical:

Leaf epidermal cells with sinuous anticlinal walls, those of the upper surface being beaded. Stomata anomocytic, in the lower epidermis only. Trichomes and calcium oxalate crystals absent. The mesophyll contains clear schizogenous oil glands and dark hypericin glands which yield a red pigment, especially at the leaf margins and on the flower parts, including the anthers. Pollen grains ellipsoidal, with smooth exine and 3 pores, about 20-25 μm in diameter (BHP, 1996).

Cimicifuga racemosa

Macroscopical:

Rhizome: dark brown externally, hard, subcylindrical 1-2 cm in diameter and up to 15cm long. bears several stout ascending branches marked with encircling leaf scars terminating in a cup shaped scar. Undersurface has attached long brittle roots sometimes broken or represented as root scars. Fractures horny, internally dark brown and waxy, or sometimes white. Exhibits a thin dark bark, a distinct cambium line and a radiate xylem 4-5mm thick consisting of pale wedges separated by darker medullary rays; pith 3-5 mm in diameter. The *root* is quadrangular, dark brown externally and longitudinally wrinkled, fracture short, internally dark brown and exhibiting a 4-rayed xylem. Odourless; taste bitter and acrid (BHP, 1996).

Microscopical:

Light to dark brown powder; starch grains numerous, simple or compound, individual grains 3-15 μm in diameter, spheroidal with a central cleft, fragments of lignified vessels with scalariform thickening or bordered pits. Heavily lignified xylem fibres, thin-walled; irregular yellow brown fragments of suberised epidermal cells, sometimes elongated, with thickened walls (BHP, 1996).

Salvia officinalis

Macroscopical:

Leaves oblong-lanceolate or ovate, 2-10 cm long and 1-2.5cm broad; apex acute, base rounded to somewhat cordate, frequently lobed; margin crenulate; upper surface grey-green and pubescent when young, nearly smooth with a depressed midrib and veins when older; lower surface light green, prominent midrib, minutely reticulate and densely pubescent; petiole 1-5 cm long, upper side grooved, grey purple (BHP, 1983).

Microscopical:

Dark green powder; epidermal fragments polygonal and thick-walled, stomata caryophyllaceous; covering trichomes long narrow, uniseriate, 2-6 celled with thick walls and sharply acute apices; glandular trichomes of two types, 1-4 celled stalk and a mono or bicellular head, sessile rosette-shaped trichomes with 6-8 encapsulated cells (BHP, 1983).

Dioscorea villosa

Macroscopical:

Irregular hard woody chips of rhizome, up to 3x 1 cm often with cork missing exposing brown exterior. Pale brown outer surface. Fine strands of brown fibrous roots present. Pale cream inner surface with small scattered yellow areas (BHP, 1983).

Microscopical:

Powder, yellow brown. Abundant simple spherical or ovoid starch grains up to 30 µm in diameter. Numerous, fragments of lignified parenchyma with thick walls containing slit-like pits. Groups of lignified tracheids with small bordered pits. Occasional groups of fibres with narrow lumen and pitted lignified walls. Few pieces of thin walled brown cork cells. A few calcium oxalate needles (BHP, 1983).

Glycyrrhiza glabra

Macroscopical:

Nearly cylindrical tapering pieces of root 15-20cm long, 0.5-3 cm in diameter. Externally brown traces of lateral roots; cork coarsely fibrous, longitudinally striated; inner surface where exposed, white to yellow and fibrous. Stolons cylindrical, 1-2 cm in diameter and may be up to several metres in length. Fractures of both root and stolon fibrous and granular. Transverse section shows thin cork, wide, yellow secondary phloem, cylindrical yellow xylem with a radiate structure. Stolon exhibits central pith. Odour characteristic; taste sweet and faintly astringent (BHP, 1983).

Microscopical:

Light yellow powder; starch grains numerous, mainly single, ovoid to ellipsoidal 2-20µm in diameter; fragments of large oval medullary ray cells; phloem fibres lignified, long, occur single or in groups, frequently surrounded by a layer of parenchyma cells each containing a single prism of calcium oxalate, 10-25µm wide; vessels large, walls with closely arranged bordered pits, often associated with lignified parenchyma; red brown cork fragments, cells polyhedral and tabular (BHP, 1983).

1.3.5 Impurities

-Potential degradation products- A UCAS public analyst will be used to ensure the herb material conforms to the quality parameter set by the British Herbal Compendium.

-Analytical test procedures and their limits of detection

-Impurities and structural deviants found

-Methods of detecting potential contamination of vegetable drugs by micro-organisms and products of micro-organisms, pesticides, fumigation agents, toxic metals, radioactivity etc.

Microbiological test will be performed to ensure that the herb material conforms to the European pharmacopoeia (2001), Herbal remedies Category 4B purity standards. Producers of the herb material are required to conform to the organic standards set. These requirements are to provide herb material that has not been treated with pesticides, irradiation or fumigants and is not cultivated on land that is contaminated with heavy metals.

-Potential falsification and adulteration

The herb material will be examined microscopically and macroscopically by trained personnel to ensure that the correct species is identified. Herbs are grown and harvested by trained staff as required by organic good manufacturing procedures.

Heavy metal analysis was undertaken with herbs samples. All were found to be within the normal range as reported by the Food Standards Agency.

Heavy metal analysis results for herbs used in NYR10

Herb	Concentration Pb DW* ppm†	Concentration Cd DW ppm	Concentration Hg DW ppm	Concentration Cu DW ppm	Concentration Zn DW ppm
<i>Hypericum perforatum</i> L.	0.48	0.12	<LOD‡	4.51	20.65
<i>Cimicifuga racemosa</i> L.	1.40	0.20	<LOD	3.10	12.82
<i>Salvia officinalis</i> L.	0.68	0.07	<LOD	1.22	15.70
<i>Dioscorea villosa</i>	1.38	0.14	<LOD	2.14	28.36
<i>Glycyrrhiza glabra</i> L.	0.50	0.80	<LOD	3.00	17.10

*DW - Dry Weight

†ppm -Parts per million

‡<LOD- Below limits of detection

1.3.6 Batch Analysis

- Batches tested - All fillers, encapsulators and mixers have to record the amount used and weight of capsules and powders. They are checked during quality control to ensure that they comply with the specifications. One hundred (g) sample(s) will be retained for testing against initial fingerprint analysis.
- Results of test with numerical values where appropriate.
- Reference material (analytical results), primary and others.

2. Other ingredients- No other ingredient will be used in the formula.

2.1 Specification and routine tests

2.1.1 Ingredients described in a pharmacopoeia

The herb material will be inspected to ensure that it meets the criteria for its monograph.

2.1.2 Ingredients not described in a pharmacopoeia

No other ingredients other than the herbs material will be used in the preparation of the formula.

2.2 Scientific data

No excipient will be used in the manufacture/assembly of the herbal capsules

3 Packaging material (immediate packaging)

No other packaging material is to be used other than that stated in Part II A, section 3.

D: Control tests on intermediate products (if necessary) No intermediate products are to be used.

E: Control Tests on the Finished Product

1. Specifications and routine tests

1.1 Product specifications and tests for release at time of manufacture

- Description/characteristics-
- Identification tests for the active ingredient(s) and antimicrobials or chemical preservatives if present- No antimicrobial or chemical preservative are in the formula.
- Quantitative determination of active ingredients/constituents of known therapeutic activity. No individual constituents is considered active since the whole herb(s) are therapeutic in combination.
- Purity tests
Microbiological test will be performed to ensure that the herb material conforms to the European pharmacopoeia (2001) Herbal remedies Category 4B purity standards for total viable count.

Total viable aerobic count: Not more than 1,000,000 aerobic bacteria

Not more than 100,000 fungi per g

Absence of *Escherichia coli* per g

Absence of *Salmonella* per 10.0 g

Thin layer chromatography and HPLC tests will be performed to monitor the herbs chemical profile.

- Pharmaceutical tests e.g. dissolution
N/A
- Tests from the appropriate general monograph
The herb material will undergo microscopic and macroscopic examinations to ensure correct identity. Ash values will be undertaken to ensure that they meet the specification on the herbal monographs. These will be performed by a UCAS accredited public analyst.

2. Scientific data

2.1 Analytical validation of methods- A UCAS accredited public analyst will be used to ensure the herb material conforms to the standards required by BHP. These will include:

- Thin layer chromatography/HPLC
- Ash values
- Macroscopic and microscopic examination
- Microbiological tests
- Heavy metal testing

2.2 Batch analysis

- **Batches tested (date, place of manufacture, batch size)**
- **Results obtained, including appropriate numerical data**

F: Stability

1. Stability tests on active ingredients

- Batch(es) tested
- General test procedures:
 - Accelerated test conditions
 - Normal test conditions
 - Analytical test procedures:
 - Assay
 - Determination of degradation products
 - Validation of all test procedures including limits of detection
 - Results of tests
 - Conclusions and how the retest period is established if not readily apparent

2. Stability tests on the finished product

- Quality specification for the proposed shelf life
- Batches tested and packaging
- Study methods:
 - real time studies
 - studies under other conditions

Accelerated stability study will be performed on the following physical parameters:

Appearance of capsule
Appearance of capsule powder
Average weight
Moisture content of capsule powder
pH of 2% aqueous suspension
Disintegration time

Thin layer chromatography and HPLC will be conducted on samples to monitor any changes in chemical profile.

- Characteristics studied:
 - physical characteristics
 - chemical characteristics
 - microbiological characteristics
 - chromatographic characteristics
 - characteristics of packaging
 - evaluation test procedures
 - description of test procedures
 - validation of test procedures
- Results of tests
- Conclusions
- Shelf life and storage conditions
- Shelf life after reconstitution
- Ongoing stability studies

A study by Bilia *et al*, (2001) measured the thermal and photostability of *Hypericum perforatum* dried extracts using flavonols, hyperforins and hypericins as markers. The results were compared with the International Conference of Harmonisation test conditions as recommended by The European Agency for the Evaluation of Medicinal Products. Photostability testing showed all constituents to be photosensitive in the tested conditions. Long term thermal stability testing showed a very low stability (less than four months) hyperforins and hypericins t-90, even if ascorbic and citric acids were added to the formulation. Bilia *et al*, (2001) failed to describe how the herbal extract was produced. A whole or powdered *Hypericum perforatum* sample is substantially different to a *Hypericum* extract and the stability data provided by this study cannot be extended to non-extract herb material. In another study by Sloley (2000), the chemical profile of various standardised *Hypericum* extracts was found to vary substantially in the concentration of various characteristic chemicals.

Q: Other information

Placebos

The placebo to be used is rice flour 4.5g per capsule.

Part III - Experimental and Biological studies

A: Non-Clinical Pharmacological and Toxicological Studies

1. Pharmacology

1.1

Hypericum perforatum

Action relevant to the proposed therapeutic use:

In a study by Perovic and Muller (1995), *Hypericum perforatum* was shown to inhibit the uptake of serotonin dose-dependent in isolated rat synaptosomes, thus increasing the concentration of this transmitter. A 50% inhibition (IC-50 value) was calculated from the dose-response curve. An IC-50 of 6.2 µg/ml of Hypericum extract was found.

In another study by Yu (2000), Hypericum was shown to weakly inhibit activities towards MAO activity. Mouse brain activities were unchanged following either acute or chronic administration of Hypericum extract. 5-HIAA levels were found to be significantly increased in the cerebral cortex, hypothalamus, hippocampus and caudate 3 hours after treatment at a dose as low as 10mg/kg. An increase in 5-HT levels was also observed in the hypothalamus and hippocampus. Plasma tryptophan levels, the precursor of 5-HT, were significantly reduced. The authors concluded, that the increased 5-HIAA and 5-HT levels following administration of Hypericum were probably unrelated to inhibition of 5-HT re-uptake. Conventional 5-HT re-uptake blockers, for example, fluoxetine, sertraline, paroxetine, cause a significant *decrease* in cortical 5-HIAA. The reduction of brain blood tryptophan and the increase of brain 5-HIAA and 5-HT seem to suggest that the utilisation of tryptophan was enhanced following treatment of Hypericum extract.

Animal studies in mice with hydroethanolic preparations *Hypericum perforatum* (corresponding to 2-12mg/kg orally) have revealed CNS activity which can be interpreted as an antidepressant effect. Oral administration of an extract equivalent to 1, 2, or 3mg/kg of hypericin in mice resulted in a reserpine antagonism, which is also indicative of antidepressant effects (Escop, 1997).

A study using different types of *Hypericum perforatum* preparations: Crude ethanol extracts, Ethyl acetate extract, aqueous extract and an Infusion were investigated on pentobarbital induced sleeping time, intestinal motility and analgesic activity. Crude ethanol extracts and Ethyl acetate extract exhibited significant stimulatory and antidepressant effects on the CNS. Both extracts prolonged sleep, increasing time up to more than 25 minutes. Ethyl acetate extract exhibited strong analgesic activity, reducing abdominal stretching activity (induced by acetic acid) by nearly 50%. Crude ethanol extracts, ethyl acetate extract and the aqueous extract exhibited spasmolytic activity (Jakovljevic, 2000).

1.2 Other actions sought (secondary pharmacology)

1.3 Drug Interactions

Hypericum perforatum

Concerns have arisen recently over potential interactions between prescribed medicines and *Hypericum perforatum*. Although some studies have been inconclusive, two clinical reports indicate that *Hypericum perforatum* increased the rate of metabolism of warfarin and cyclosporin and that blood levels were reduced by approximately 50% (Qin-Ying Yue, 2000; Ruschitzka, 2000). A study with *Hypericum perforatum* and digoxin also indicated that *Hypericum* potentiated the effect of the drug. However, the placebo group had a 9% decrease in digoxin levels and therefore the variation may reflect known variability in digoxin distribution or systematic availability (Johne, 1999). Nonetheless, real concerns regarding potential interactions mean that *Hypericum perforatum* should not be used concurrently with a range of prescribed medications.

2. Pharmacokinetics

Hypericum perforatum

The bioavailability of hypericin and pseudohypericin was established using doses equivalent to 0.1% and 0.3% hypericin (Staffeldt, 1994). The t-max of hypericin administered at 0.1% has been found to be 2.5 hours, with a C-max of 4.3 ng/ml, and a plasma half-life of approximately 6 hours. The t-max of hypericin administered at 0.3% was 4-6 h, with a C-max 1.5-14.2 ng/ml and a plasma half-life of 24.8-26.5h. The t-max of pseudohypericin was 2-4h, with a C-max of 2.7-30.6 ng/ml, plasma half-life 16.3-36 hours (Staffeldt, 1994). Median half time elimination of hypericin was found to be 24.8 to 26.5 hours and the median half time elimination of pseudohypericin was found to be in the range of 16.3 to 36 hours (Staffeldt, 1994).

3. Single and repeat dose toxicity studies

Hypericum perforatum

In clinical studies, *Hypericum perforatum* has consistently been shown to be well tolerated by patients, with an extremely low incidence of side effects (Kim, 1999). Therapeutic dosages of total hypericin, (up to 1mg daily over 8 days), have been shown not to induce photo-sensitivity in 40 volunteers, (Escop, 1997). A study using synthetic hypericin given intravenously to HIV-infected patients found that (reversible) symptoms of photo-sensitivity were observed at the highest dosage regime but that these symptoms were reversible. The dosage found to induce photo-sensitivity was 35 times higher than the highest oral dosage of total hypericin used in the treatment of depressive disorders (Escop, 1997).

In a further study by Brockmuller, (1997) 13-volunteers received either a single dose of hypericin at dosages of 900, 1800 or 3600mg of a standardised *Hypericum* extract containing 2.81, 5.62 and 11.25 mg of total hypericin or a placebo. All treatments were combined with solar simulated irradiation. No differences were found between patients receiving placebo or *Hypericum* extracts and no dose-related trend in light sensitivity was observed.

4. Mutagenicity No data available

5. Carcinogenicity No data available

6. Reproductive toxicology No data available

7. Other information - No further studies conducted.
8. Presentation of non-clinical pharmacological and toxicological studies

B: Clinical Data and Previous Human Experience

1. Human Pharmacology

Pharmacological studies in humans

Depression may be caused by a deficiency in biogenic amines, e.g. serotonin (5-hydroxytryptamine) and norepinephrine. Antidepressants act by increasing availability of these neurotransmitters. Consequently, a series of modes of action of a potential antidepressant can be postulated: inhibition of monoamine oxidase, (MAO) inhibition of serotonin or reuptake modulation of synthesis of biogenic amines.

In a study, six women with depressive symptoms were given a standardised hydroethanolic extract of *Hypericum perforatum* equivalent to 0.5-mg total hypericin or 1.4g herb. A significant increase in urinary neurotransmitter metabolites was observed 2-hours after administration. The same preparation was studied for a 4-week duration on 40 depressive patients. Relaxing effects were observed as indicated by EEG tests which showed an increase in theta activity, decrease in alpha activity and no change in beta activity (Escop, 1997).

2. Human Pharmacokinetics

Hypericum perforatum

The bioavailability of hypericin and pseudohypericin was established using doses equivalent to 0.1% and 0.3% hypericin. The hypericin administered at 0.1% had a t-max of 2.5 hours, C-max 4.3 ng/ml, plasma half-life of approximately 6 hours. The 0.3% extract for hypericin was t-max 4-6 h, C-max 1.5-14.2 ng/ml, plasma half-life 24.8-26.5h. Pseudohypericin t-max 2-4h, C-max 2.7-30.6 ng/ml, plasma half-life 16.3-36 hours (Staffeldt, 1994). Median half time elimination of hypericin is 24.8 to 26.5 hours. Median half time elimination of pseudohypericin ranged between 16.3 to 36 hours (Staffeldt, 1994).

3. Normal volunteer studies

4. Patient studies

One hundred and eleven female patients aged between 43-65 were recruited from a general medical and psychotherapy practice. Patients had either pre- or postmenopausal climacteric symptoms. All patients received *Hypericum perforatum* preparations for 12-weeks. The dosage was standardised to 300µg total hypericin per tablet, three times per day. After 12-weeks climacteric complaints had diminished or disappeared completely in a clear majority of women (76.4% by patient self-rating [$p < .001$] and 79.2% by physician rating [$p < .001$]). Only four women reported adverse events, which consisted in an increase in, sleep disturbances, slight nausea, dizziness and headache. All adverse events were recorded in the first week of treatment. No patient withdrew from treatment because of these adverse events (Grube, 1999).

5. Post market surveillance - N/A

6. Extensive previous human use

Cimicifuga racemosa

1. Pharmacology

1.1 Action relevant to the proposed therapeutic use:

Constituents of *Cimicifuga racemosa* rhizome have been shown to bind to oestrogen receptors in rat uteri and pituitary glands (Harnischfeger, 1985), but some controversy exists as to what oestrogenic effects result from occupying these sites. Duker *et al* (1991) characterised pharmacological responses to various chromatographically separated fractions of *C. racemosa* lipophilic extract in ovariectomized rats. Three endocrinologically active fractions were isolated. Fraction I inhibited Lutenising hormone (LH) secretion but did not bind to oestrogen receptors. Fractions IV to VI were active in both assays, while fraction VIII displayed the most potency in oestrogen receptor binding assays, and did not suppress LH secretion after chronic treatment. This fraction did inhibit LH after a single acute injection; single injections of oestradiol showed a similar activity profile.

The authors suggest that the lack of an effect on Follicular Stimulating Hormone (FSH) inhibition is due to FSH secretion being under the control of steroids plus inhibin, while LH secretion is mediated only by gonadal steroids. The authors speculated that Fraction VIII, which acutely but not chronically inhibited LH secretion may contain oestrogenically active compounds, which are rapidly metabolised so that only a transient suppressive effect on LH secretion is produced. This may provide a rationale for the demonstrated clinical efficacy of *C. racemosa* in the treatment of menopausal hot flushes. The pulsatile release of LH is inhibited, but overall LH levels are not suppressed.

Fraction I, which was non-oestrogenic but did suppress LH secretion, may contain alpha-2 agonists similar to clonidine, which suppresses LH secretion without binding to the oestrogen receptor (Duker *et al*, 1991). While this and other studies (Jarry and Harnischfeger, 1985) on ovariectomized rats, as well as menopausal women, demonstrated reduced (LH) levels, a new study by Einer-Jensen, (1996) indicates a lack of oestrogenic effects in rats and mice.

A recent study by Liske (1998) also found no significant decrease in LH (or other hormonal changes) or other measures of oestrogenic activity such as, increased vaginal epithelium thickness are attributable to the *Cimicifuga racemosa* preparation, at least when the new lower dose is used.

Isopropanolic aqueous extracts of *Cimicifuga racemosa* inhibit *in vitro* proliferation of oestrogen-dependent breast cancer cell lines in a dose-dependent manner. This is interpreted as an oestrogen-receptor blockade by the extract (Nesselhut *et al*, 1993). In a follow-up study, *Cimicifuga* prevented the stimulation of oestrogen-dependent cancer cells when oestrogen was added *in vitro*. Tamoxifen and *Cimicifuga* may act synergistically to block oestrogenic proliferation of breast cancer cells, because the combined inhibitory effect was greater than the sum of the effect of each substance alone (Nesselhut *et al*, 1998, submitted).

Two recent studies of other *Cimicifuga* species, *C. foetida* and *C. heracleifolia*, demonstrated inhibition of parathyroid hormone-induced bone reabsorption in tissue culture (Li *et al*. 1996) and in ovariectomized rats (Li *et al*, 1995). This anti-

osteoporotic effect has not, as yet, been discussed in the literature, in terms of the oestrogen receptor-binding activity of *Cimicifuga*, although mention was made of the positive influence of *C. racemosa* on osteoporotic states by Murray (1997).

Results of a recent study on the influence of an isopropanolic aqueous extract of *Cimicifuga racemosa* on the proliferation of MCF-7 cells showed that the extract did not stimulate the proliferation of oestrogen receptor-positive breast cancer cells (Liske, 1998).

A double-blind randomised clinical study by Liske *et al* (1998) looked at the effects of two different dosages of an isopropanolic *Cimicifuga racemosa* extract (Remiferin) in 152 patients with climacteric complaints. The dosages were 40mg vs. 127mg of the preparation per day for six months. Efficacy was measured using the Kupperman menopause index, Self-assessment Depression Scale (SDS), the Clinical Global Impressions scale (CGI), vaginal cytology indexes, and hormone status (lutensising hormone (LH), follicle stimulating hormone (FSH), estradiol 17 beta (E2), prolactin and sex hormone binding globulin (SHBG) levels).

The two dosages showed similar results in efficacy and safety. The product did not influence hormone levels of LH, FSH SHBG, prolactin and oestradiol. Vaginal cytology (degree of proliferation) was not changed (Liske, 1998).

A summary of outcomes showed a statistically significant decrease in the Kupperman index and SDS depression scale under treatment with Remifemin, at both dose levels. Efficacy was rated as good or very good by both doctors and patients in about 80% of the cases. The treatments at both dose ranges were rated as well tolerated, by 95% of the women and 92% by their doctors. The company reports 'no conspicuous changes' in vaginal cytology parameters or in the course of hormone concentrations for treatments at both dose levels. Although no details are given on adverse effects, they report no serious adverse events or clinically toxicological effects (Shaper & Brummer, 1997).

1.2 Other actions demonstrated or sought (secondary pharmacology)

1.3 Drug interactions - No data available

2. Pharmacokinetics - No data available

3. Single and repeat dose toxicity studies

In a multicentre drug monitoring study of 704 individuals with climacteric complaints, women were treated with *C. racemosa* extract for 6-8 weeks. In 93% of patients, tolerability was very good. Mild and transitory symptoms, gastrointestinal complaints were observed in only 7% (Stolze, 1982).

In another study by Vorberb (1984), tolerability in all cases was described as good to very good, only four patients reported mild gastrointestinal problems at the beginning of therapy.

A 6-month oral toxicity study in rats followed by an 8-week recovery period indicated no toxic potential of the isopropanolic *C. racemosa* preparation, even at very high doses (up to 5000-mg/kg body weight). No abnormalities were noted in clinical, chemical, histopathological, or macroscopic organ findings compared with the simultaneously treated control group (Murray, 1997; Levy, 1997; Remifemin, 1997).

Toxicity assessments for the chloroform extract (Minimum lethal dose, MLD) range from as low as >3.0 mg/kg (s.c, 30 days) in the rabbit to as high as >1 g/kg (oral, 30 days) in the rat (Napralert). In Wistar rats given up to 5000 mg Remifemin granulate/kg for 26 weeks, no conspicuous chemical or organ toxicity was observed (Korn, 1991). In human studies with the fluid extract, up to 890 mg/day was given with no evidence of toxic effects (Novitch & Schweiker, 1982).

Overdoses may produce nausea with vomiting, and dizziness, and may reduce pulse and induce perspiration (Duke, 1985). Occasional gastric problems are the only noted adverse effects noted by (Schaper & Brummer 1997). Willard (1991), describes a mild non-violent emetic property, which can cause nausea as well as giddiness and headache in large doses. Shengma (mainly *C. foetida*, *C. dahurica*) can cause vomiting due to gastric irritation (Chang & But 1986).

Cimicifuga racemosa has been given in daily doses of 200mg without adverse effects, (Liske, 1998). Patient tolerance for *Cimicifuga racemosa* has been assessed as very good, with only gastrointestinal complaints of low frequency and degree having been reported in some studies (Stolze, 1982). The dosage to be used is more than one and a half times lower than the maximum recommended dosage as cited by Newall (1996).

4. Mutagenicity

In vitro Salmonella microsome assays (Ames test) showed no evidence of a mutagenic potential of *C. racemosa*. Compared with the negative control, neither a dose related doubling or a biologically relevant increase in the mutant count with or without 'S9-mix' (simulation of mammalian metabolic effects by homogenized mammalian liver together with cofactors) was observed (Beuscher, 1995; Remiferin, 1997).

Extracts of *C. racemosa* have not shown any toxic or mutagenic properties demonstrated in any animal or human studies. After chronic application to mice of a commercial preparation over a period of 6-months, no clinically or histopathologically relevant results were found. For the trial doses of up to 5g/kg body weight were used (Clay, 1996).

A 40% isopropanolic dry extract of *C. racemosa* equivalent to 535.5 mg/kg body weight/day of the drug, which is approximately 700 times the human therapeutic dose given orally to rats for 6-months, produced no relevant clinical or histopathological changes and using the Ames test, revealed no mutagenic activity in a concentration equivalent to 30.3 mg of the drug per plate (Boblitz, 2000).

Ames test (in vitro Salmonella microsomal assay) results showed no evidence of mutagenic potential of the isopropanolic extract of *C. racemosa* (Liske, 1998).

Dosages of 0.32 to 1000 micrograms per plates were used with negative and positive controls (Schaper & Brummer, 1997).

5. Carcinogenicity- No data available
6. Reproductive toxicology -No data available
7. Other information -No further studies conducted
8. Presentation of non-clinical pharmacological/toxicological studies

B: Clinical Data and Previous Human Experience

1. Human pharmacology

A randomised, double blind study was conducted with 80 female volunteers with menopausal symptoms (Stoll, 1987). Patients received Remifemin, (2 x 1mg tablets, b.i.d.), or conjugated oestrogens (0.625 mg) or placebo for 12 weeks. Remifemin treated patients showed a significant increase in proliferation of vaginal epithelium compared to oestrogens and placebo, and significant improvements of somatic and psychological parameters (Kupperman menopausal Index, Hamilton Anxiety Scale) compared to oestrogen and placebo. No clear improvements were seen in the perimenopausal of the placebo group

2. Human pharmacokinetics

3. Normal volunteer studies

4. Patient studies

An open study was conducted on 50 female patients with severe menopausal symptoms, who converted from an oestrogen injection regime to oral Remifemin, (2 x 1mg tablets, 2X/day), with additional hormonal injections given in cases of severe complaints (Petho, 1987). Over the course of the study (6 months), clear improvements were observed in symptoms, as measured by the menopausal index (reduction from 17.6 to 9.2, $p < 0.001$). Over half (56%) of the patients required no further hormone injections; additional hormone injections were needed in only 18% of the patients. Side effects were minimal and well tolerated, with 82% of the patients reporting the success of the Remifemin therapy as very satisfactory.

5. Post market surveillance -N/A

6. Extensive previous human use

Salvia officinalis

1. Pharmacology

1.1 Actions relevant to the proposed therapeutic use

A dialysate of the aqueous extract of fresh sage showed antihydrotic activity in humans. Excessive sweat production induced by pilocarpine was inhibited (Escop, 1997). In an open study of 80-patients with idiopathic hyperhidrosis 80 patients were treated for four weeks. 40 patients were given 440mg of dried aqueous sage leaf extract. This corresponds to 2.6 mg of the drug and 40-patients were given an infusion (4.5g daily). The reduction of sweat secretion achieved (less than 50%) was comparable for both treatment groups, although slightly stronger in the group treated with extract (Escop, 1997).

Intravenous injections of extracts from *S officinalis* in cats at a dose of 100 mg/kg caused a 30 per cent decrease in blood pressure after 90 minutes. A duodenal injection of *S officinalis* in cats at a dose of 300mg/kg, produced a decrease in blood pressure by 15 per cent. Spasmolytic activity on smooth muscle action was also investigated and *S officinalis* extract inhibited smooth muscle contractions by 70-85 per cent (Todorov *et al*, 1984).

Salvia officinalis has been shown to suppress pilocarpine induced hyperhidrosis almost completely. The essential oil has a spasmolytic action acetylcholine induced contractions of isolated rat intestine are immediately suppressed by *Salvia officinalis* (Braun, 1974).

1.2 Other actions sought (secondary pharmacology)

1.3 Drug interactions

Salvia officinalis (dried herb leaf), as reported in the ESCOP monograph 1997, has no known contraindications or interactions with other medicines. However, the use of *Salvia officinalis* is not recommended during pregnancy as a precautionary measure. The daily dosage to be prescribed in this trial is five times lower than the safe recommended dosage stated in the 1997 ESCOP monograph for this herb.

2. Pharmacokinetics - No data available

3. Single and repeat dose toxicity studies- No data available

4. Mutagenicity - No data available

5. Carcinogenicity - No data available

6. Reproductive toxicology - No data available

7. Other information

8 Presentation of non-clinical pharmacological and toxicological studies

B: Clinical Data and Previous Human Experience

- 1 Human pharmacology -No data available
- 2 Human pharmacokinetics -No data available
- 3 Normal volunteer studies -No data available
- 4 Patient studies -No data available
- 5 Post market surveillance -N/A
- 6 Extensive previous human use

Dioscorea villosa

1. Pharmacology

1.1 Action relevant to the proposed therapeutic use

1.2 Other actions sought (secondary pharmacology)

1.3 Drug interactions- No data available

2. Pharmacokinetics - No data available

3. Single and repeat dose toxicity studies - No data available

4. Mutagenicity - No data available

5. Carcinogenicity No data available

6. Reproductive toxicology No data available

7. Other information

8. Non-clinical pharmacological and toxicological studies- No data available

B: Clinical Data and Previous Human Experience

1. Human pharmacology- No data available

2. Human pharmacokinetics- No data available

3. Normal volunteer studies- No data available

4. Patient studies - No data available

5. Post market surveillance- N/A

6. Extensive previous human use

Glycyrrhiza glabra

1. Pharmacology

A methanolic extract of *Glycyrrhiza glabra* was used to elucidate the possible *in vivo* interaction of acetaminophen (AAP) with herbs. Acetaminophen is a widely used analgesic and antipyretic, which produces hepatotoxicity in both humans and laboratory animals at excessive doses (Moon, 1996). The effect of *Glycyrrhiza glabra* was measured on the overall biotransformation of AAP in rats. This was achieved by measuring the effect of *Glycyrrhiza glabra* on the activity of Ugt1A as well as on the concentration of UDP-glucuronic acid to determine if *Glycyrrhiza glabra* affects glucuronidation in rat liver. Biliary and urinary excretion of AAP-glucuronide was increased by *Glycyrrhiza glabra* without influencing the excretion of AAP-sulphate and Aap-thioether conjugates. The finding suggests that *Glycyrrhiza radix* (GR) activates a detoxification pathway of AAP mediated by UGT in rats. The increased urinary excretion of AAP-glucuronide does not seem to be due to a diuretic effect of GR since GR did not change the urine flow rate and total urine volume significantly. The author concluded that this result, along with the reported effects of *G. glabra* on enzyme leakage from injured rat hepatocytes, suggested a possible application of *Glycyrrhiza glabra* for detoxification of xenobiotics.

1.1 Actions relevant to the proposed therapeutic use

1.2 Other actions demonstrated or sought (secondary pharmacology)

1.3 Drug interactions - No data available

2. Pharmacokinetics

The active principle of *Glycyrrhiza glabra* is Glycyrrhizin also known as (glycyrrhizic acid) (G) and its main metabolite is glycyrrhetic acid (GA). Glycyrrhetic acid is formed presystematically by enzymatic hydrolysis in the intestines and is a potent competitive inhibitor of 11-B-Hydroxysteroid dehydrogenase (11-B-HSD). Its type two isoenzyme 11-B-HSD2 converts the mineralocorticoid and glucocorticoid cortisol into its active metabolite cortisone. When 11-B-HSD2 activity is impaired, intrarenal cortisol concentrations will rise. Edema, hypertension and electrolyte disturbances may become apparent due to increased mineralocorticoid activity (Walker and Edwards, 1994). In subjects who developed adverse affects after repeated (G) intake, 11-B-HSD2 activity was impaired (Armanini, 1996).

The pharmacokinetics of pure Glycyrrhizin (G) and its aglycone, glycyrrhetic acid (GA) were compared with 'crude' *Glycyrrhiza glabra* containing equivalent levels of G and GA. Significantly lower concentrations of G were found in bile samples from rats administered with 'crude' *Glycyrrhiza glabra* compared with pure G. Furthermore, *Glycyrrhiza glabra* presented a significant choleric affect 20% reduction in time of elimination of G after oral consumption, which increases the excretion rate of G. Based on the ratio of AUC-16h for pure G and *Glycyrrhiza glabra*, exposure to the effects of G is 7.4 times less in the case of *Glycyrrhiza glabra* compared to a physiologically equivalent dose of pure G (Cantelli-forti, 1997).

Pharmacokinetic Model

The pharmacokinetics of glycyrrhetic acid (GA) in humans after ingestion of both GA and Glycyrrhizin G were described in a model developed by Ploger and Mensinga (2000). In this model, the gastrointestinal tract (GI) is described by a two-compartmental model, representing the stomach and the gut. In this model, a first order transit rate of GI contents is assumed. In the gut, G is absorbed as its aglycon GA after first order enzymatic hydrolysis by commensal bacteria. A two-compartmental model, representing the liver and remaining tissues, describes the systemic kinetics of GA. After hepatic uptake, GA is metabolised instantaneously and its metabolites are subsequently excreted into the bile (Ploeger and Meulenbelt, 2000). After biliary excretion, metabolites are stored in the gallbladder. It is assumed that these metabolites are excreted instantaneously into the gut when a fat-containing meal is consumed. Once excreted, the metabolites are reconverted into GA by commensal bacteria and reabsorbed into the systemic circulation.

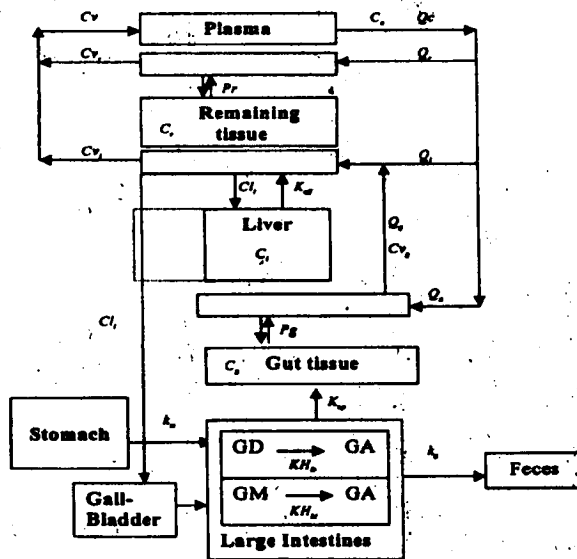

Abbreviation	Parameter
Cl_{ex}	First-order efflux clearance from effect compartment
Cl_l	Plasma to liver and plasma to bile clearance (L/h)
Cl_l/C	Plasma to liver and plasma to bile clearance (L/h/kg liver weight)
C_x	Concentration ($\mu\text{g/L}$) GA in venous ($x = v$), arterial ($x = a$), venous liver ($x = vl$), liver ($x = l$), gut ($x = g$), or remaining tissue ($x = r$)
GA	Glycyrrhetic acid
GD	Glycyrrhizinic acid
GM	Glycyrrhetic acid conjugates
IC50	GA plasma concentration at 50% effect ($\mu\text{g/L}$)
k_a	First-order transit rate of gastrointestinal contents through small and large intestines (h^{-1})
K_{ex}	Hepatic efflux (h^{-1})
KH_G	First-order hydrolysis rate constant (h^{-1}) of GD ($x = D$) or GM ($x = M$)
k_{con}	First-order conversion rate of cortisol into cortisone (h^{-1})
k_{ga}	First-order gastric emptying rate constant (h^{-1})
K_{up}	First-order GA uptake rate constant (h^{-1}) in the small and large intestines
P_b	Partition coefficient for gut ($x = g$) or remaining ($x = r$) tissue
Q_c	Cardiac output (L/h)
Q_l	Perfusion rate (L/h) of Liver by hepatic artery ($x = l$), portal vein ($x = g$), or remaining tissue ($x = r$)
$T_{1/2ga}$	Time (h) in which 50% of the contents passed the small and large intestines

3. Single and repeat dose toxicity studies

No effect level. Results from experimental data in humans established a no effect level for a daily intake of 2-mg/kg-body weight. An acceptable daily intake of 0.2-mg/kg-body weight can be extrapolated with a safety factor of 10. This means consumption of 12mg glycyrrhizic acid per day for a person with a body weight of 60kg. This would be equal to 6g of *Glycyrrhiza glabra* a day, assuming that *Glycyrrhiza glabra* contains 0.2% of glycyrrhizic acid (Van Geldren, 2000).

Patients taking aqueous extracts of *Glycyrrhiza glabra* containing 814mg Glycyrrhetic acid GA have been shown to develop arterial hypertension after two-weeks of ingestion. Patients taking 108mg and 217mg of GA daily did not develop any side-effects including arterial hypertension (Bernardi, 1994). The daily dose of *Glycyrrhiza glabra* to be used in this study is 0.5g crude herb and will contain approximately 25mg GA, which is eight times lower than the known safe concentration identified.

4. Mutagenicity - No data available

5. Carcinogenicity- No data available

6. Reproductive toxicology - No data available

7. Other information

8. Presentation of non-clinical pharmacology and toxicological studies

B: Clinical Data and Previous Human Experience

1. Human pharmacology

Glycyrrhiza glabra extract has been shown to stimulate exocrine pancreatic secretions in rats (Ishii, 1979). Also *Glycyrrhiza* extract administered in the duodenum causes a significant increase in plasma secretin concentrations in humans (Shiatori, 1984). A more recent study by Shiatori (1986) investigated the effects of *Glycyrrhiza* extract on release on endogenous secretin in seven human volunteers. Intrajejunal administration at three different doses (200, 400 and 800 mg/30min) resulted in significant increases in both plasma secretin concentration and pancreatic bicarbonate output in a dose dependent manner. However, it did not influence pancreatic secretion or protein amylase.

2. Human pharmacokinetics

3. Normal volunteer studies

4. Patient studies

5. Post market surveillance -N/A

6. Extensive previous human use

References

- Armanini D, Lewicka S. (1996). 'Further studies on the mechanism of the mineralocorticoid action of licorice in humans'. J Endocrinol. Invest. 19, p624-29.
- Beuscher, N. (1995) 'Cimicifuga racemosa. Die Traubensilberkerze'. Z Phytother. 16, p301-10.
- Bernardi M, Dintino P.E, Trevisani F, Cantelliforti G, Raggi M.A, Turchetto E, Gasbarrini G. (1994). 'Effects of prolonged ingestion of graded doses of licorice by healthy volunteers'. Life Sciences. 55, (11), p863-872.
- Bilia A.R, Bergonzi M.C. (2001). 'Evaluation of the chemical stability of St. John's wort commercial extract and some preparations'. International Journal of Pharmaceutics 212 (1), p199-208.
- Boblitz N, Liske E, Wustenberg P. (2000). 'Traubensilberkerze- Wirksamkeit und Sicherheit von Cimicifuga racemosa in der Gynakologie'. Deutsche Apotheker Zeitung (in press).
- Braun, H. (1974). Heilpflanzen-Lexikon fur Arzte und Apotheker Stuttgart: Fisher Verl. p253.
- Brockmuller J, Reum T. (1997). 'Hypericin and pseudohypericin: pharmacokinetics and effects on photosensitivity in humans'. Pharmacopsychiatry 30 (2), p94-101.
- British Herbal Compendium. (1992). (P, Bradley ed.). Dorset: British Herbal Medicine Association.
- British Herbal Pharmacopoeia. (1983) British Herbal Medicines Associations: Bournemouth, UK.
- British Herbal Pharmacopoeia. (1996). British Herbal Medicines Associations: Bournemouth, UK.
- Cantelli-forti G, Raggis M.A. (1997). 'Toxicological assessment of licorice:biliary excretion in rats'. Pharmaco Res. 35, (5), p463-70.
- Chang H.M, Butt P.H. (1986). Pharmacology and Applications of Chinese Materia Medica (vol 1), World Scientific.
- Clay A, Reichert R. (1996). 'Cimicifuga racemosa L.-Black cohosh'. Q Rev Nat Med. Spring, p19.
- Cuvelier M, Berset C, Richard H. (1994). 'Antioxidant constituents in sage (*Salvia officinalis*)'. Journal of Agricultural and Food Chemistry 42, p665-9.
- Duke, J.A. (1985) Handbook of Medicinal Herbs. Boca Raton: CRC Press.

- Duker E.M, Kopanski L, Jarry H, Wuttke W. (1991) 'Effects of extracts from *Cimicifuga racemosa* on gonadotropin release in menopausal women and ovariectomized rats'. Planta Medica. 57, p420-424.
- Einer-Jensen N, Zhao J, Anderson K.P, Krisoffersen K. (1996). 'Cimicifuga and Melbrosia lack oestrogenic effects in mice and rats'. Maturitas 25, p149-153.
- ESCOP, (1997). Monographs, Exeter: United Kingdom
- Grube B, Walper A. (1999). 'St John's wort extract: Efficacy for menopausal symptoms of psychological origin'. Advances in therapy. 16, (4), p177-86.
- Harnischfeger J.H, Duker E. (1985). 'Studies on the endocrine effects on the contents of *Cimicifuga racemosa*, II: in vitro binding of the compounds to oestrogen receptors'. Planta Medica. 1, p46-9.
- Ishi Y, Terada M. (1979). 'Effect of Fm100, a fraction of licorice root on exocrine secretion from rat pancreas'. Pharmacol. 29, p664-6.
- Jakovljevic V, Popovic M. (2000). 'Pharmacodynamic study of *Hypericum perforatum*'. L'. Phytomedicine. 7, (6), p449-53.
- Jarry H, Harnischfeger G. (1985). 'Studies on the endocrine efficacy of the constituents of *Cimicifuga racemosa*: 1. Influence on the serum concentration of pituitary hormones in ovariectomised rats'. Planta Medica. 51, (1), p46-49.
- Johne, A. (1999). 'Pharmokinetic interaction of digoxin with an herbal extract from St John's Wort'. Clin Pharmacol Ther. 66, p338-45.
- Kim, H.L, Streltzer J, Goebert D. (1999). 'St. John's wort for depression: a meta-analysis of well-defined clinical trials' J Nerv Ment Dis. 187, (9), p532-8.
- Koeda M, Aoki Y, Sakurai N, Nagai M. (1995). 'Studies on the Chinese crude drug 'Shoma' IX. Three novel cycloanostanol xylosides, cimicifugosides H-1, H-2 and H-5 from *Cimicifuga rhizome*'. Chem. Pharm. Bull. 43, (5), p771-76.
- Korn, W.D. (1991). 'Six-month oral toxicity study with Remifemin granulate in rats followed by an eight-week recovery period'. International Bioresearch. Hannover Germany.
- Liske E, Wustenburg P. (1998). 'Therapy of climacteric complaints with *Cimicifuga racemosa*: herbal medicine with clinically proven evidence'. Menopause. 5, (4), p250.
- Liske, E. (1998). 'Therapeutic Efficacy and safety of *Cimicifuga racemosa* for gynecological disorders'. Advances in Therapy 15, p45-53.
- Leung A.Y, and Foster S. (1996). Encyclopedia of common natural ingredients used in food, drugs, and cosmetics. (2nd ed). New York: Wiley.

- Levy, B. (1997) File: black cohosh (*Cimicifuga racemosa*), menopause, Remifemin. Herb Clip.
- Li J.X, Miyahara T, Li H.Y. (1995). 'Anti-osteoporotic activity of traditional medicines: active constituents of *Cimicifuga rhizoma*' Wakan Iyakugaku Zasshi. 12, p316-17.
- Li J.X, Kodata, S, Li H.Y, Miyahara T, Namba T. (1996). 'The effect of traditional medicines on bone reabsorption induced by parathyroid hormone (PTH) in tissue culture: a detailed study on *Cimicifuga rhizoma*'. Wakan Iyakugaku Zasshi. 13, p50-58.
- Mabberley, D.J. (1987). The Plant book. London: Cambridge University Press.
- Moon, A and Kim, S.H. (1996). 'Effect of *Glycyrrhiza glabra* roots and Glycyrrhizin on the glucuronidation in rats'. Planta Medica. 62, p115-19.
- Murray, M. (1997). 'Remifemin: Answers to common questions. American J of Natural Medicine 4 (3), p3-6.
- Newall C.A, Anderson L.A, Phillipson, J.D. (1996). Herbal Medicines, a Guide for Health-care Professionals. London: Pharmacological Press.
- Nesselhut T, Borth S, Kuhn W. (1998). 'Influence of *Cimicifuga racemosa* extracts on the *in vitro* proliferation of mammalian carcinoma cells'. in press.
- Nesselhut T, Schellhase T, Dietrich C, Kuhn W. (1993) 'Untersuchungen zur proliferativen Potenz von Phytopharmaka mit Ostrogenähnlicher Wirkung bei Mammakarzinom-Zellen'. Arch Gynecol Obstet. 254, p817-818.
- Novitch C.A and Scheiker R.S. (1982). 'Orally administered oral drug products for over-the-counter human use, establishment of a monograph'. Federal Register 47, p55076-55101
- Perovic S, Muller W.E.G. (1995). 'Pharmacological profile of Hypericum Extract: effect on serotonin uptake by postsynaptic receptors'. Arzneim- Forsch/Drug Res. 45 (11), p1145-48.
- Petho, A. (1987). Arztl. Praxis. 47, p1551-53. Cited in: Schaper & Brummer (1995).
- Ploeger, B.A and Mensinga J. (2000). 'Human physiologically based model glycyrrhizic acid, a compound subject to presystemic metabolism and enterohepatic cycling'. Pharm Res. in press.
- Ploeger B.A, Meulenbelt J. (2000). 'Physiologically based model for glycyrrhizic acid a compound subject to presystemic metabolism and enterohepatic cycling'. Appl. Pharmacol. Toxicol. 162, p177-88.
- Qin-Ying Yue. (2000). 'Safety of St John's Wort'. The Lancet. 355 (9203), (Feb 12), p576.
- Remifemin, (1997). Active ingredient: Cimicifuga fluid extract: A plant based Gynecological Agent. Scientific brochure. Salzgitter: Schaper & Brummer.

- Ruschitzka, F. (2000). 'Acute heart plant rejection due to St John's Wort'. The Lancet. 355, p548-549.
- Schaper & Brummer (1997) Remifemin: A Plant-based Gynecological Agent. Scientific Brochure.
- Shiatori, K and Wantanabe S. (1996). 'Effect of licorice extract (Fm100) on release of secretin and exocrine pancreatic secretions in humans'. Pancreas. 1, (6), p483-87.
- Shiatori K, Watanabe S. (1984). 'Effect of a fraction of a methanol extract of licorice root on the release of secretin in humans'. Jpn J Gastroenterol. 81, p124.
- Sloley B.D and Urichuk L.J. (2000) 'Chemical and pharmacological evaluation of Hypericum perforatum extracts'. Acta Pharmacologica Sinica. 21 (12), p1145-52.
- Staffeldt B, Kerb R. (1994). 'Pharmacokinetics of hypericin and pseudohypericin after oral intake of the hypericum perforatum extract LI 160 in healthy volunteers'. Geriatr Psychiatry Neurol. 7, (Suppl 1), p47-53.
- Stoll, W. (1987). 'Phytopharmakon Influences Atrophic Vaginal Epithelium. Double-Blind Study: Cimicifuga vs. Estrogenic Substances'. Therapeuticum. 1, p123-31.
- Stolze, H. (1982) 'An Alternative to Treat Menopausal Complaints.' Gyne. 4, p314-6.
- Stuck D, Tegtmeier M, Harnischfeger G. (1997). 'Flavones in extract of *Cimicifuga racemosa*'. Planta Medica. 63, p289-290.
- Todorov S, Philianos S, Petkov V. (1984). 'Experimental Pharmacological Study of Three Species from Genus Salvia'. Acta Physiologica Et Pharmacologica Bulgaria 10 (2), p13-20.
- Yinrong L, Teap F. (1999). 'Rosmarinic acid derivatives from *Salvia officinalis*'. Phytochemistry 51, p91-4.
- Yu P.H. (2000). 'Effects of the Hypericum perforatum extract on serotonin turnover in the mouse brain'. Pharmacopsychiatry. 33, p60-5.
- Van Geldren, CEM. (2000). 'Glycyrrhizic acid: the assessment of a no effect level'. Human and Experimental Toxicology. 19 (8), p434-39.
- Vorberg G. (1984). 'Therapy of climacteric complaints' Zeitschrift fur Allgemeinmedizin 60, p626-29.
- Walker B.R, Edwards C.R. (1994). 'Licorice induced hypertension and syndromes of apparent mineralocorticoid excess'. Endocrinol Metab. Clin North Am. 23, p359-77.
- Willard T. (1991). The Wild Rose Scientific Herbal. Wild Rose College of Natural Healing Ltd: Calgary.