

## Research Article

# Inventory Control Systems Model for Strategic Capacity Acquisition

**Anthony S. White and Michael Censlive**

*School of Science and Technology, Middlesex University, The Burroughs, Hendon, London NW4 4BT, UK*

Correspondence should be addressed to Anthony S. White; [a.white@mdx.ac.uk](mailto:a.white@mdx.ac.uk)

Received 20 June 2016; Revised 18 September 2016; Accepted 12 October 2016

Academic Editor: Uday Venkatadri

Copyright © 2016 A. S. White and M. Censlive. This is an open access article distributed under the Creative Commons Attribution License, which permits unrestricted use, distribution, and reproduction in any medium, provided the original work is properly cited.

Variation of installed industrial capacity has been found to follow a cyclic pattern. This paper discusses the application of control theory to the problem of the timely acquisition of extra production capacity. The control system based model presented here is compared with a System Dynamics model proposed by Sterman. Key differences are the method of implementing rational decisions about deployment of extra capacity and the use of a nonlinear APVIOBPCS inventory model. Benefits of this new model are a more measurable process and the ability to select parameter values to optimise capacity deployment. Simulation of the model indicates that the results found by Sterman underestimate the production backlog and time taken to reach equilibrium. The use of a Proportional, Integral, and Derivative (PID) controller in the capacity control loop model illustrates that it is possible not only to alter the backlog levels but at the same time to reduce the sales force and improve the revenue. The model also shows clearly that the impact of not increasing capacity promptly results in catastrophic failure of sales as a structural, rather than a business, problem. This model is simple enough to be implemented as a spreadsheet for use as a guide by managers.

## 1. Introduction

Today's consumer market is dominated by two main factors: one is the need for rapid development of new products and the other is the need for an equally rapid response to market led demand. Business cycles have long dominated economic analysis but most researchers have concentrated on examining the average effects on the economy discussing the long term expansion and decline of the whole system (Sterman and Mosekilde, [1], King and Rebelo, [2] and European Commission [3]). These reports confirm the existence of cycles that vary over a period of less than one year in various sectors of the economy. Sterman ([4] pp. 792–797) shows that similar cyclical changes occur in many industry sectors over a number of years. His analysis using System Dynamics (SD) illustrates that these cycles are due to the structure of the system and not primarily due to outside (exogenous) circumstances. One of the principle conclusions of SD analysis is that all businesses operate under very similar dynamics. Sterman's [5] work on decisions made by managers using a "Flight Simulator" approach to operating supply

chains shows how those decisions affect the dynamics of the operation, often causing severe oscillatory performance. Decisions based on small changes in the appreciation of the market conditions have severe effects on the whole process. In particular managers appear unable to forecast the behaviour of systems which have considerable delays. Lyneis [6] reported a number of general lessons gained from the "Flight Simulator" including failing to account for competitive response and mistaking forecasts for reality. This misperception of feedback by managers was also used by Langley et al. [7] to explain capacity overshoot. Companies have to make strategic market-based decisions about the capacity of their plant in relatively rapidly changing circumstances as well as catering for customer preferences. Forrester [8], shortly after inventing System Dynamics, devised market growth models to test how rational decisions would affect market performance. These models were devised in order to advise entrepreneurs as well as high-tech companies and were intended to examine the observation that some companies succeeded while others grew for a short time and then stagnated and eventually failed. Nord [9] identifies

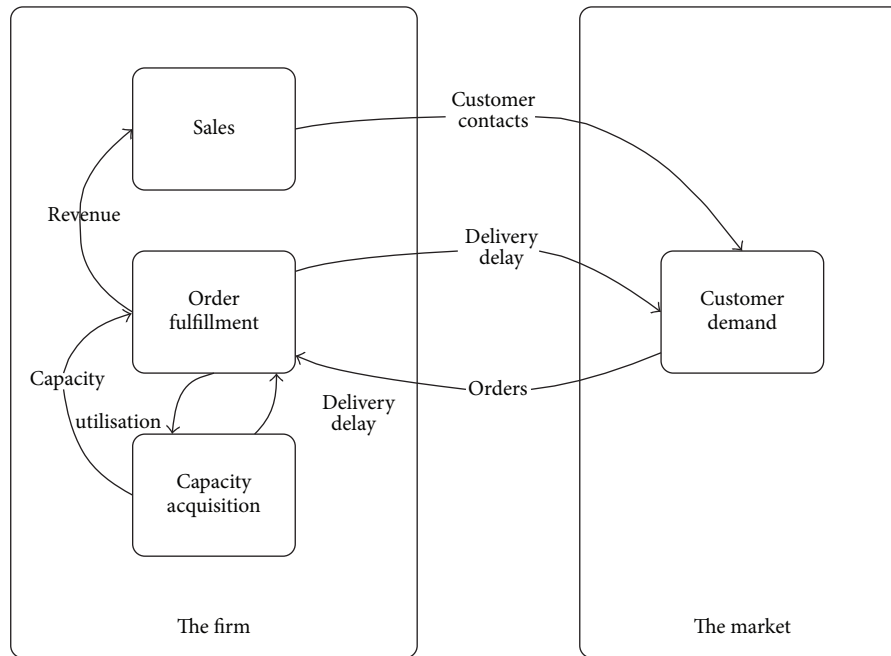

FIGURE 1: Sectors of the market growth model (after Morecroft [12]).

the capacity acquisition policy as a major factor in 52% of the cases of companies that failed within 5 years of start-up and he suggested that the use of different management policies can either suppress or exacerbate the oscillatory growth. No obvious reason could be found for failure other than the decisions taken by managers in response to market changes. Morecroft [10–12], using a System Dynamics model, has linked the decision-making process and the strategy development that is supported within the company. The basic model of Morecroft intended to capture the essence of the decision process is shown in Figure 1.

Morecroft's [12] model splits the problem of market growth into two interactive regimes: (a) the internal operations of the firm and (b) the actions of the external market forces. Morecroft's approach shows market forces external to the company model and their interactions with the company model can be represented by a number of feedback loops, which describe Morecroft's three key factors: customer contacts, delivery delays, and the placement of orders.

Although the model described here was intended for high-tech companies the challenges involved in capacity planning are more generic. Bakke and Hellberg [13] examined the problems in three different sectors: maritime equipment, paper manufacture, and power production. They identify a number of similar problems in MRP operations, across all three sectors including instability caused by too much data in MPS systems, neither load nor capacity being accurately known, and needing improved planning and reduction of lead times. They also show capacity data exhibiting cyclic behaviour very similar to the results shown herein later. Due to the nature of innovative products, there is little historical data available for companies to use to forecast demand; the only methods available are comparison with lifecycles

of analogous products or the application of the predictive methods pioneered by Bass [14] and Bass et al. [15].

In view of the risks to the large amount of capital invested and the time factors involved manufacturers normally take a very cautious approach to building up capacity. It is of particular importance in supply chain design that the decisions regarding supply chain capacity and the policy of capacity increases or decreases are as efficient as possible. The decisions susceptibilities can be classified into three broad areas:

- (1) capacity levels that do not meet the full actual demand leading to nonavailability of products, loss of revenue, and market share;
- (2) delays in acquiring new capacity that involve considerable risk and may result in loss of both a market opportunity and invested capital;
- (3) excess capacity that results in low plant utilisation and ties up capital leading to low return on investment.

Wild [16] defines capacity management as the cost effective matching of capacity to demand and states that "managers must consider current capacity; and the required future capacity, and the costs in implementing decisions" for any proposed capacity change.

Akkermans et al. [17] have suggested that plant capacity specification is a one-time decision. This stance is not normally the real world experience of most manufacturing companies since because of technological developments they often face the combined pressures of a decreasing product life cycle, shorter times to market, and a cost-driven reliance on outsourcing, all of which require frequent changes in capacity to remain competitive.

Karrabuk and Wu [18] examined the capacity planning strategy in the semiconductor industry claiming a near optimal investment policy which reconciled marketing and manufacturing. Wu et al. [19] reviewed the literature on managing capacity in high-tech industries with an emphasis on conventional inventory strategy choices such as the Newsvendor (“Newsboy”) models and multiperiod models with capacity adjustments. The tendency to optimise investment based on uncertain incentives results in difficult choices in rapid market changes. The authors above applied the methods to semiconductor wafer production. An SD model was used by Adl and Parvizian [20] to investigate food production. Their work is showing some cyclic capacity variation similar to that obtained here.

The factors underlying financial reasons for investment are not well behaved continuous linear functions and the key financial decisions in a company are normally made only when the strategic case for investment or disinvestment is very clear cut (Ceryan and Koren [21]). Usually such decisions are strictly dependent on current and short range predicted sales, that is, short range strategic planning.

The correct timing of an indicated capacity expansion is therefore vital. This paper describes an implementation of Sterman’s [4] model, itself based on Forrester’s original [8] proposal for modelling market growth. This is compared to an APVIOBPCS model (White and Censlive [22]) using a modified control system which allows capacity to be increased after a deliberation time using different decision protocols. Sterman was interested in modelling “high-tech” companies with their attendant dependence on technology. In this case the products are usually innovative with few competitors and companies must rely on their own dynamics for success or failure. Either they sell their products or the customers have nothing. Capacity acquisition decisions were found to be the key strategy that dominated the success or failure of these firms.

The purpose of this paper is to investigate an improved model of capacity acquisition developed by incorporating rate of change of demand effects and simplifying the criteria for decisions thus enabling an earlier intervention. This approach derives from Sterman’s observation that managers are unable to effectively detect rates of change of demand for long lead times.

We will show that a linear control based model of a production system combined with a nonlinear inventory subsystem is able to represent the average behaviour of the system capacity and using Proportional, Integral, and Derivative (PID) control improves the model’s overall performance, reducing the oscillatory behaviour of the Sterman model.

## 2. Review

We now review relevant work on capacity management by other researchers, especially concentrating on System Dynamics (SD) models outlying their principal conclusions. Modelling the behaviour of systems including supply chain effects has traditionally used SD methods based on the work of Forrester [23] (Angerhofer and Angelides [24]). System

Dynamics models are widely used in modelling business processes and are chosen for their capability to represent the effects of physical flows as well as information flows in implementing the respective time delays of the variables. In System Dynamics modelling it is important to understand the structure of the interconnection between elements forming the model because this dictates the behaviour of the model. In systems models the structure is interconnected by feedback loops, one or more of which will be dominant and dictate how the whole system responds to disturbances. It is important also to realise that most SD modellers incorporate into their models “real world” data from one or more relevant companies in the form of nonlinear lookup tables, so that while the models are supported by industry specific data their usefulness is limited in any general applications outside the particular systems studied.

Capacity modelling results reported in the literature, such as Suryani [25], can deal with strategic issues (with which we are concerned here) or with the more immediate localised production control issues. These problems are related to the timescale of the planning exercise (Sterman [4]). Rajagopalan and Swaminathan [26] argue that the increase in product variety may not result in excessive inventory or a substantial increase in setting up times or an increase in costs due to the effects of adding capacity to cope with the variety. Anderson et al. [27] use a System Dynamics (SD) model of a supply chain. Their results show that any tendency to impose system wide targets increases variance in both demand and backlog. They confirm the commercial correctness of establishing any constraining backlog service points to be as near as possible to the end use customer.

As Sterman et al. [28] suggest “if firms were well informed and could forecast accurately, capacity would match orders well (at least on average). Alternatively, even if forecasting ability were poor, capacity would match demand if it could be adjusted rapidly and at low cost.” One significant paper dealing with strategic problems is that of Yuan and Ashayeri [29]. Their paper uses Sterman’s work and develops a control systems model with costing included. Their model uses all the functions used by Sterman and is hence nonlinear; their results show that the success of a supply chain is directly dependant on the intercompany cooperation and on the delays in the system generated by the chain structure. Kamath and Roy [30] have investigated a comprehensive System Dynamics model of capacity augmentation for short product lifecycles finding that the loop dominance of the coupling between the order and production outweighs the effects of delivery delay on the dynamics of capacity growth. Vlachos et al. [31] have shown that, for production systems where remanufacturing/reuse is present, optimum response is obtained when the review period is short, that is, less than the system time delays.

The second class of problems pursued in the current literature (Duffie et al. [32]) is concerned with effects in reconfigurable flexible plant; for example, Wiendahl and Breithaupt [33] applied control theory to the problem of production control and devised the current methods of “logistic curves” and the “funnel model,” invoked by Nyhuis [34], to set up closed loop control of a PPC. Asi and Ulsoy [35]

analysed capacity management for a reconfigurable manufacturing system using stochastic market demand and developed solutions to reduce delays in varying capacity. Son et al. [36] examined the costs in line balancing reconfigurable systems with scalability. Several of these authors have used PID (Proportional, Integral, and Derivative control) to improve the system response. PID control was proposed for supply chain use by several authors including Sharp and Henry [37], Towill and Yoon [38], and White [39].

Orcun et al. [40] used System Dynamics models to compare the effect of various clearing functions for capacity models on the production planning process. A significant finding was that the fixed lead time assumption fails to give accurate representation of the process at high capacity utilisation levels. Elmasry et al. [41] have used SD models to investigate scalable capacity manufacturing systems and they found the existence of critical conditions relative to system breakdown. The role of control systems analysis in this type of problem is therefore long established and can produce useful general results.

Investigations were undertaken by Georgiadis and colleagues at the University of Thessaloniki using SD to model a range of closed loop supply chains which included a remanufacturing component (Georgiadis et al. [42], Vlachos et al. [31], Georgiadis and Politou [43], Georgiadis [44], and Georgiadis and Athanasiou [45]). The earliest of these papers shows the effect of changes in product lifecycle on the overall performance of the process. It is claimed that for their model the “optimal parameters are insensitive to the product demand level.” The paper by Vlachos et al. [31] examined the use of various “green” strategies based on measuring the economic performance obtained by varying the amount of recycled materials. Drum-Buffer-Rope production planning and control approach using an assumed “normally distributed demand was investigated and indicated insensitivity of performance measures of manufacturing to changes in control parameters.” Georgiadis [44] investigated the use of SD models in the paper industry to observe how recycling strategies could maximise profitability.

Georgiadis and Athanasiou [45] also cite evidence that overcapacity in the US helicopter manufacturing industry appeared to reduce levels of technical innovation.

Cannella et al. [46] examined a capacity constrained supply chain of 4 echelons with capacities at 6 different values finding that the strategic implications required the elimination of information distortion to match the supply to demand. The ultimate problem is to match the costs of investment in new capacity to prospective profits as the work of Ceryan and Koren [21] indicates.

All the above cited papers indicated that the observed responses of the models developed showed the presence of cyclical capacity variation.

### 3. Sterman Models

This section will introduce the model created by Sterman and its limitations and explain the basic equations used in the model. The MATLAB™/Simulink™ version of that model

used here is described together with sample responses for comparison.

Sterman's [4] model of a single firm competing in an unlimited market is shown in Figure 2 and was derived from Forrester's [8] model of market growth. Both Nord [9] and Packer [47] used similar models. That the models could be relevant to various industries was shown by Leihl et al. [48] who applied a similar model to the business cycles in the airline market, producing similar oscillations that we find later. The Sterman model was used to test the theories of bounded rationality [11] in an attempt to determine why most new companies fail. Some companies grow and then stagnate while others suffer periodic crisis with a small number that grow and prosper. The SD model was devised to examine how bounded rational decisions could produce failure. In more recent times the early problems reported from the analysis of the financial state of Amazon were due to lack of available warehouse capacity.

This model based on the analysis of Forrester and Morecroft assumes that the firm manufactures high-tech products as a build-to-order system. It was not based on one company but it included most of the representational features of such companies while being as simple as possible. However it includes data derived from averaging a number of responses to critical questions. The system model shown in Figure 2 contains three key variables: states, sales force, and backlog and recent revenue. There are three loops incorporating feedback with delays due to reporting and delivery. Orders are accumulated as a backlog until they have been produced and shipped. The actual delivery delay, basically the residence time in the backlog, is the ratio of backlog to the current shipment rate. The ratio “book-to-bill” [order book = backlog level, billed = shipped and paid for] is a typical management measure of the health of companies. If this ratio is greater than unity then the company is growing, insofar as the order level continues to increase and hence an increase in production capacity is justifiable. Desired production rate in the model depends on the backlog, but also on the normal or average value for the delivery delay. For local managers capacity is given by the available machinery at a particular time and the decision to change the capacity of the plant is taken by senior management in response to a perception that the sales will exceed capacity by a sufficient amount at some future date. Operations managers can only respond to demand by increasing the local capacity utilisation. When desired production is less than plant capacity, managers sometimes prefer to run down the backlog rather than lay off skilled workers and have idle plant. The formulation of desired capacity was designed to capture important aspects of bounded rationality. Forrester had observed that senior managers were very conservative about capital investment, being very reluctant to invest in new plant until they were sure that new capacity would not be underutilised! They did not trust sales forecasts, basing their decisions on missed delivery dates (because these are actual events not forecasts), by which time it was often too late to recover that customer.

The Simulink representation of Sterman's model presented here uses the relationships and equations with the variables expressed as continuous functions of time, for

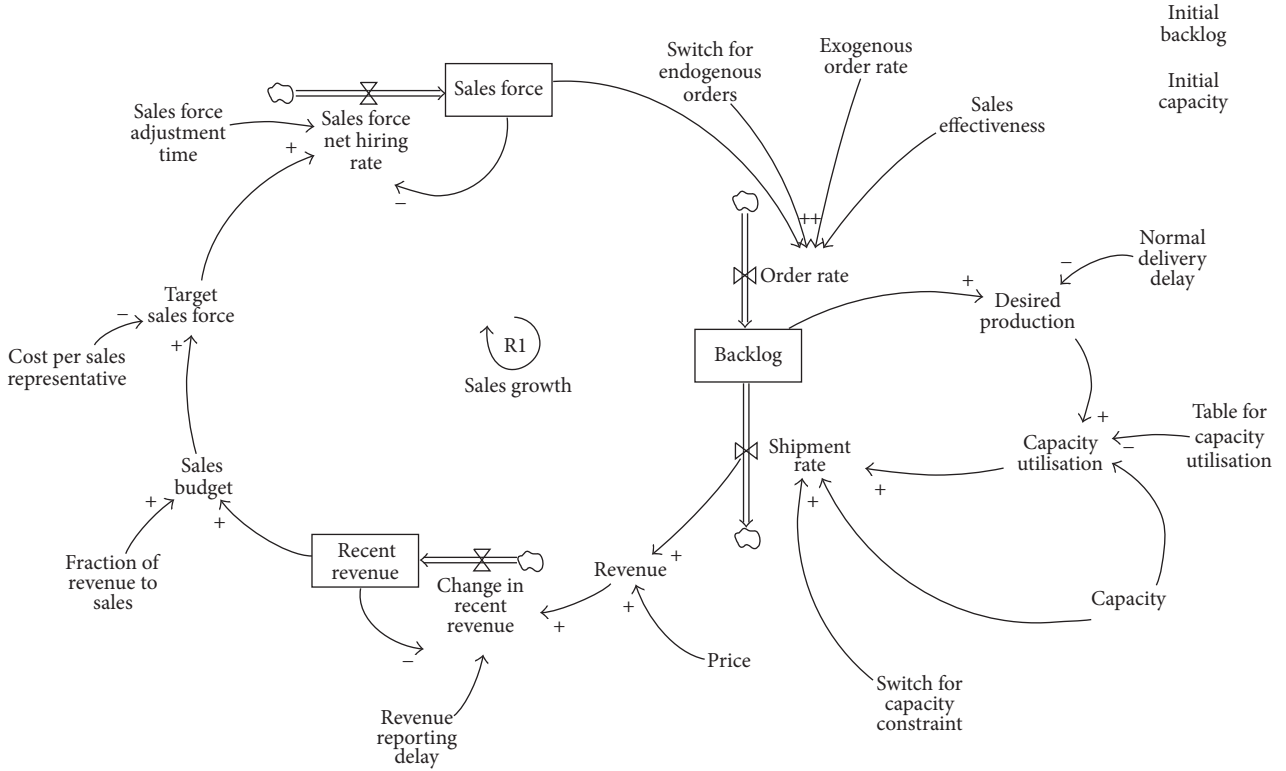

FIGURE 2: Sterman's SD model for high-tech company growth.

example,  $OR(t)$  rather than discrete data. Two cases are considered by Sterman, one where the orders are generated by the sales force, whose numbers are governed by the success they have and a second case where orders come from outside only (exogenous). The equations relating the problem are described below. Considering the continuous variable case; we can develop the following equations.

The rate of change of the backlog LEVEL (BL) is the difference between the order rate (OR) and the shipping rate (SR):

$$\frac{dBL(t)}{dt} = OR(t) - SR(t), \quad (1)$$

$$DD(t) = \frac{BL}{SR}(t).$$

Delivery Delay (DD) is the ratio of backlog to shipping rate

$$SR(t) = CAP(CU, t). \quad (2)$$

Shipping rate is equal to the current capacity (CAP) multiplied by the capacity utilisation (CU)

$$CU(t) = f\left(\frac{DP(t)}{CAP(t)}\right). \quad (3)$$

Capacity utilisation is some function of the ratio of desired production (DP) to capacity

$$DP(t) = \frac{BL(t)}{NDD}. \quad (4)$$

Desired production is the ratio of backlog to normal delivery delay (NDD)

$$CAP(t) = \text{smooth } 3(DCAP, T_{cad}). \quad (5)$$

Capacity is the smoothed delay value of desired capacity (DCAP) with characteristic time constant  $T_{cad}$

$$DCAP(t) = (CAP(t))(EEPDC). \quad (6)$$

The desired capacity is equal to the current capacity multiplied by the effect of expansion pressure on desired capacity (EEPDC)

$$EEPDC = f(PEC). \quad (7)$$

Effect of expansion pressure on desired capacity is a function of the pressure to expand capacity (PEC)

$$PEC(t) = \frac{DDPC}{cgdd}. \quad (8)$$

The pressure to expand capacity is expressed by the ratio of the delivery delay perceived by the company (DDPC) to the company goal for delivery delay (cgdd)

$$DDPC(t) = \text{smooth}(DD, T_{cpdd}). \quad (9)$$

The delivery delay perceived by the company is a smoothed value of the delivery delay with a timescale of  $T_{cpdd}$ .

The mathematical performance of the system is dictated by three differential equations. In the Simulink representation

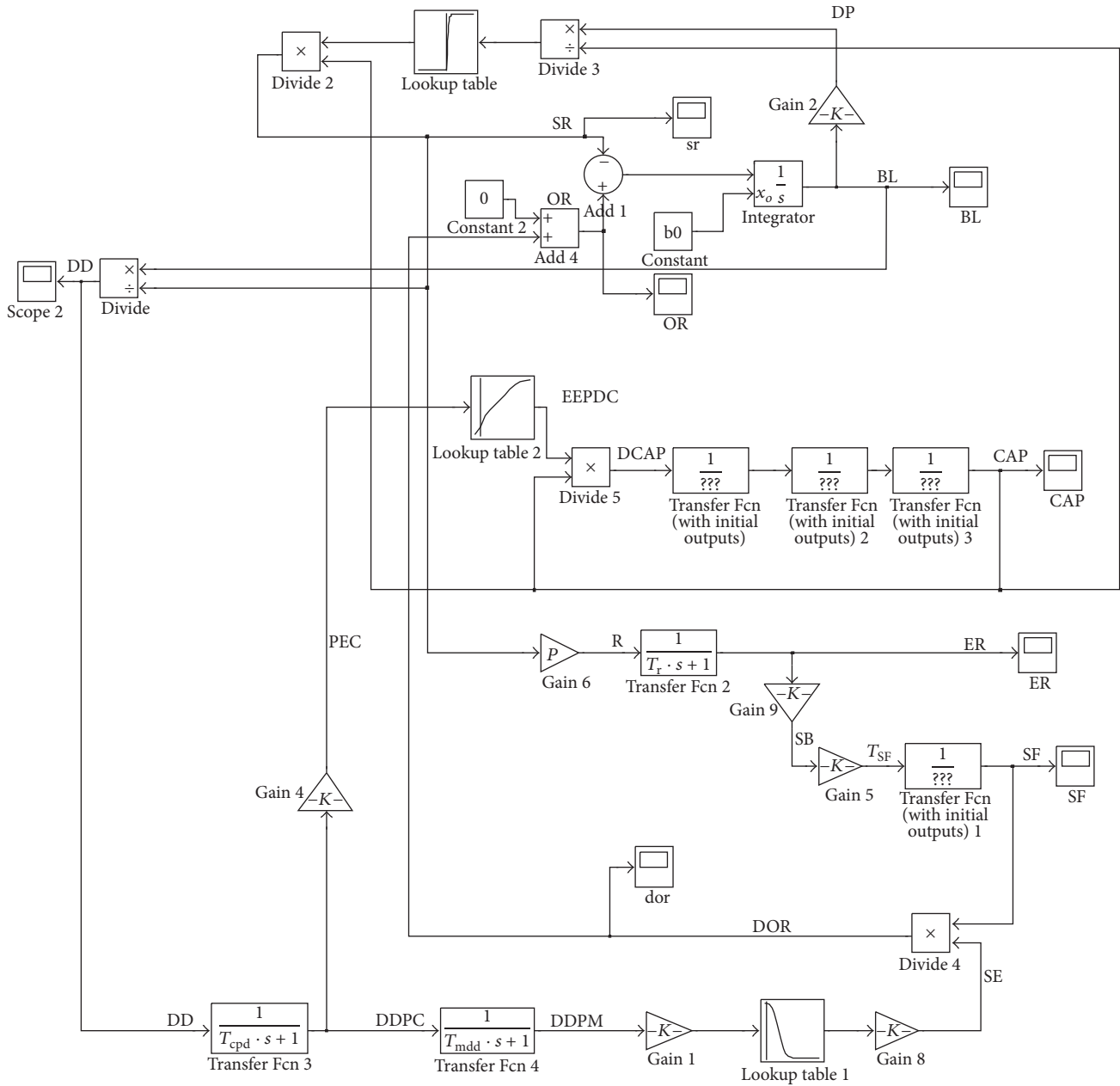

FIGURE 3: Simulink version of Sterman's Model.

of Figure 3 we use three integrators to solve these equations; these are shown as integrator blocks. The scaling of variables is achieved with the triangular gain blocks and the output of variables shown on oscilloscope blocks. Simulink is a general simulation package used with MATLAB and is more versatile than the SD packages in current use. Its use allows more complex analysis to be used. The outputs from the two packages agree well, since they solve the same equations generally using the same numerical procedures, but MATLAB can use different algorithms.

The smooth function in (5) and (9) is a higher order delay used in SD models rather than a simple exponential

function. This usually arises when the information about a process takes some time to reach the decision maker and it will thus take time to register and obtain a response. The capacity utilisation and the effect of expansion pressure on desired capacity are implemented in the SD software by semiempirical lookup tables based on trend observations of specific real company operations, and these produce the highly nonlinear response. For the present model these lookup tables together with the divisors had to be recast if a linearised control system model was to be created. The decision tables put into the Sterman model are traditional SD tabulated functions, in this case using ratios of variables

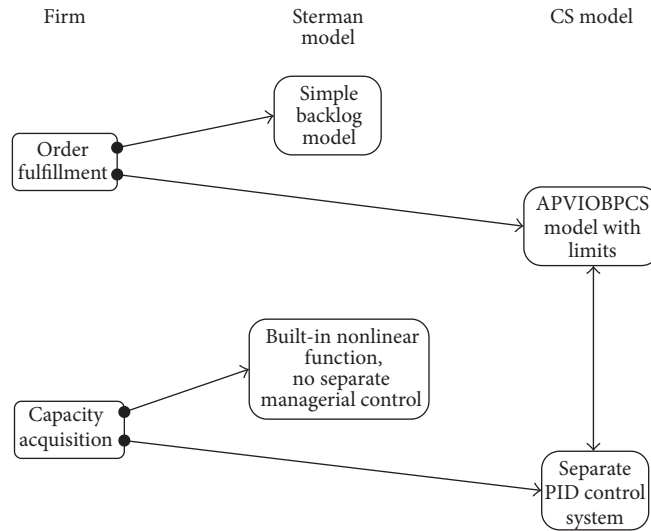

FIGURE 4: Comparison of the Stermen and new CS Models.

such as desired production divided by capacity to give the utilisation. These are implemented as 2D lookup tables in the Simulink model.

#### 4. New Model

This section outlines the basis of the new control system (CS) model used to improve the behaviour of a variable capacity firm. The changes from the Stermen model in order for the manager to regain control over the capacity increase process are outlined. In the Stermen model the production capacity is outside the control of the order fulfillment organisation. In the new CS model this parameter is brought under the direct control of management as a key decision factor. The fundamental differences between the two models are indicated in Figure 4. The capacity controller interacts with the limits in the APVIOBPCS subsystem. The inventory representation in the CS model is comprehensive and the control of the capacity allows automatic variations to reach the target level of capacity chosen by the manager. The new CS model is shown in a Simulink implementation in Figure 5.

The purpose of the new model variant reported here is to address two common issues reported in the literature:

- (i) Firstly, the capacity acquisition process was not timely enough to prevent companies failing. So the aim was to devise a new decision process that would prevent the oscillatory problems seen in the SD model. This was a clear conclusion from the work of Forrester, Morecroft, and Stermen. At a process level it was also the conclusion reached by Deif and ElMaraghy [49]. The intent therefore was to produce a model variant that included some provision of automatic decisions at least in the operational area to speed up capacity utilisation to provide information that

capacity is effectively being used that can be relied upon by senior managers.

- (ii) Secondly, the Stermen model does not include the inventory control procedures normally used by managers and hence does not include all the associated delays which would be significant to the operation of the whole system. Based on this factor alone it would be expected that a real system would respond more slowly than the Stermen model.

The change in the decision process goes to the core of the problem. Stermen [5] has shown experimentally that small changes in decisions can have great effects on the response of the whole process. The decision process using differences rather than ratios is a fundamental change that has significant results. The justification for using straight differences is that, in most quality procedures, using control charts, for example, data is compared directly with set values for tolerances as one example. So we can argue that managers are already disposed to compare their data with a predisposed set value. In most biological systems, for example, a difference is recognised and acted on. The difference between a set value and a system value is the basis of control for all systems. This is a description of a control system in the regular sense, normally computed automatically in a control system.

These SD lookup tables were then replaced with a smoothed function constant and the formulation of the extra capacity defined by relationships for the error in (i.e., difference between) capacity (ECAP) and the desired capacity:

- (i) The delays in the inventory production and forecasting process were not modelled in Stermen's work. To include this factor a subsystem model of an automatic pipeline and variable inventory order based production control system (APVIOBPCS) was added to the simulation. In this implementation the desired





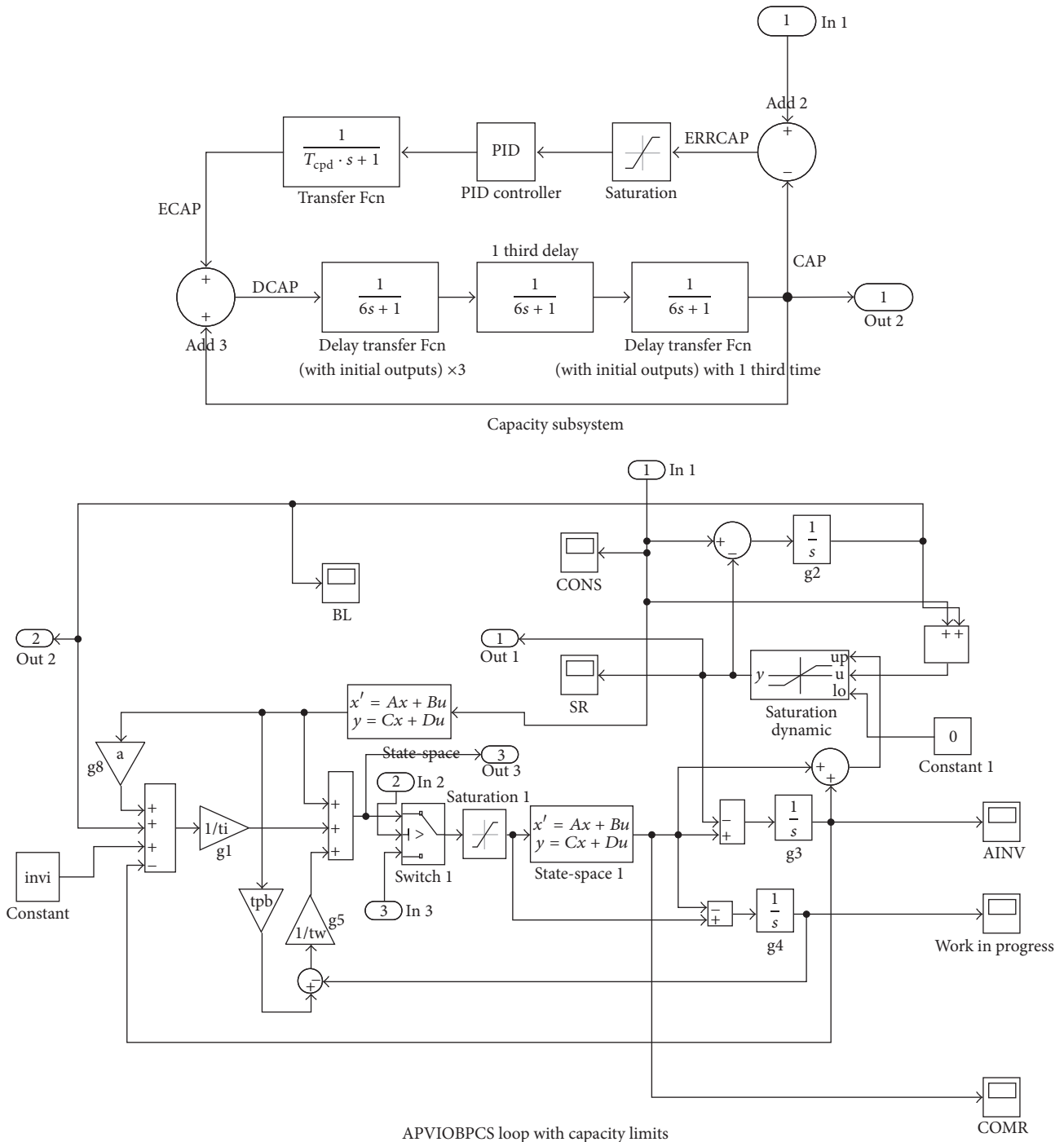

FIGURE 6: Capacity and inventory subsystems.

a subsystem consisting of an APVIOBPCS inventory model. In this subsystem actual levels of delivered items are limited to the current capacity that is controlled by the capacity loop subsystem. Only positive production and order rates are allowed by including a saturation block in both paths.

The smoothing functions and delays were then replaced by simple first-order delay functions (blocks). In the Simulink models information transmission is represented by the

arrows. The overall model is shown in Figures 5 and 6 where the smoothing function is replaced by a series of three delays between DCAP and CAP represented by the block transfer function.

Another modification made to Sterman's original SD form was the addition of PID control for the system gains (Figure 6). Apart from this modification the other system constants used in this paper are the same as used by Sterman.

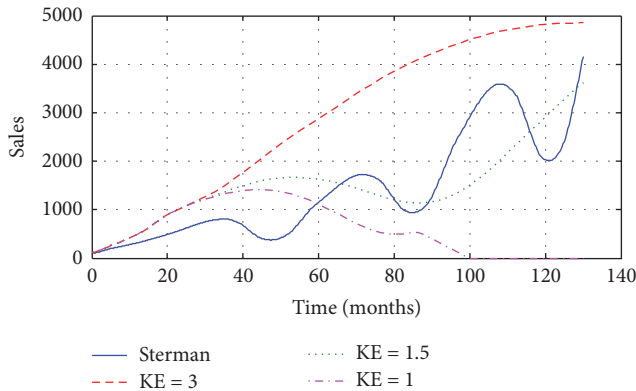

FIGURE 7: Order rate performance of the two models.

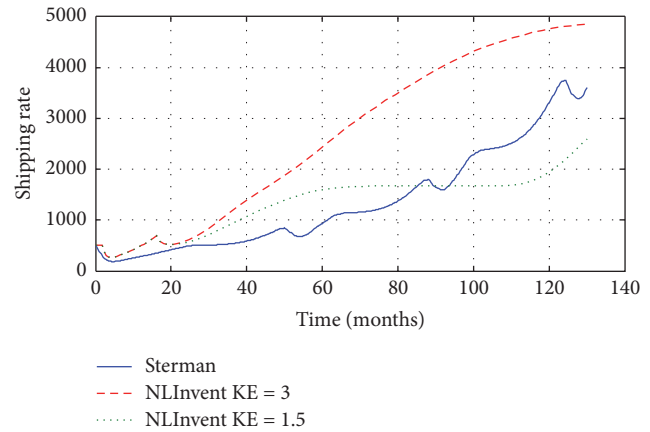

FIGURE 8: Shipment rate.

PID control has been widely used in industry and has a term that allows for rates of change to be smoothed and long term errors to be eliminated. It includes a term as in the Sterman model proportional to the input and including a term that integrates the error and a term proportional to the rate of change of the error.

The justification for including PID functions follows from Diehl's [51] work that suggests that when managers are expected to make decisions about process orders they are unable to make predictions that include a measure of trends and allowance for material in the pipeline. This is often because of the long time-scales in inventory processes. The strategic scaling issues considered here could be of an even longer timescale and we believe that managers cannot detect long term trends allowing for the effects of variation of rate of change. This will be taken care of by the PID controller.

The CS model can be compared to the very much simpler models of White and Censlive [52, 53]. The results of a comparison of the responses of two implementations, Sterman and CS, are shown in Figures 7–23. KE here is the control factor in the hands of the manager where they can decide to increase the amount of capacity deficit to implement.

## 5. Results

In this section the results from the two models, Sterman's model and the new CS model, will be compared. Two sets of results are presented here; the first set of results is for the case where there is no exogenous or external input; here sales are generated by the in-house sales force.

Figure 8 illustrates the response of both the Simulink version of Sterman's model and the new control system (CS) model. In this figure the solid line is the Sterman SD model data from the Simulink version using Euler integration. However the Sterman model results differ significantly from those of the linearised control model, shown with the dashed line for  $KE = 3$  and by the dotted line for  $KE = 1.5$  which does not show the large oscillations. Significantly the curve for  $KE = 1$  shows that the sales decline to zero after 100 months. This is because the projected capacity cannot match demand. The behaviour predicted by the Sterman model is

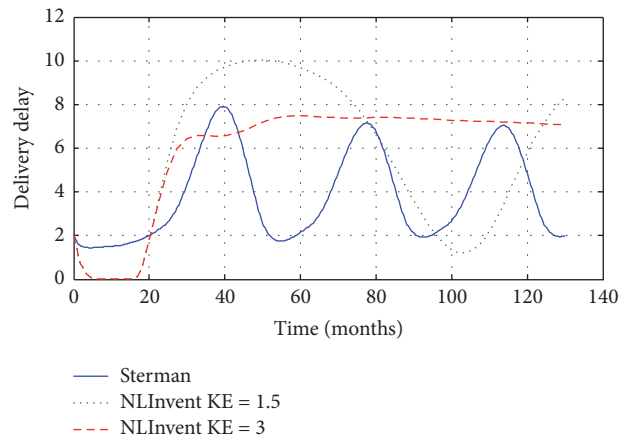

FIGURE 9: Delivery delay.

that the company goes through repeated boom and bust cycles. During the sales slumps the orders drop by up to 50%. This would probably cause the managers to be fired and severe retrenchment in the business. The business might even be subject to takeover during this phase. The slump in sales for the CS model is catastrophic for the company. It could be avoided by timely increase in capacity.

It is clear that the structure of the SD model and hence the company upon which it is based has serious structural flaws if operated as the model predicts. Since the decision processes are fairly simple we can see what the effect of the nonlinear functions is since these introduce higher order dynamics. From experiments conducted by Sterman it is clear that managers cannot readily appreciate these higher order dynamics. The key to controlling the growth of this company would be to increase capacity in a timely manner. Using the CS model it is easier to see when to implement capacity changes.

The control system model for different values of proportional gain KE provides a similar range of results to those of the Sterman model, but without the large oscillations. The sales rate (Figure 7) is in line with the values shown for the Sterman model. But for the shipment rate (Figure 8)

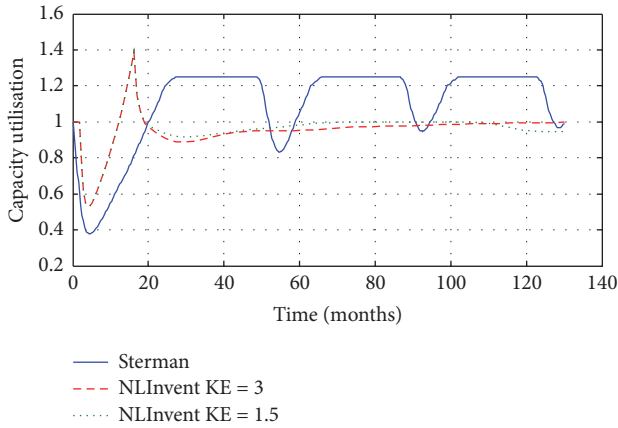

FIGURE 10: Capacity utilisation.

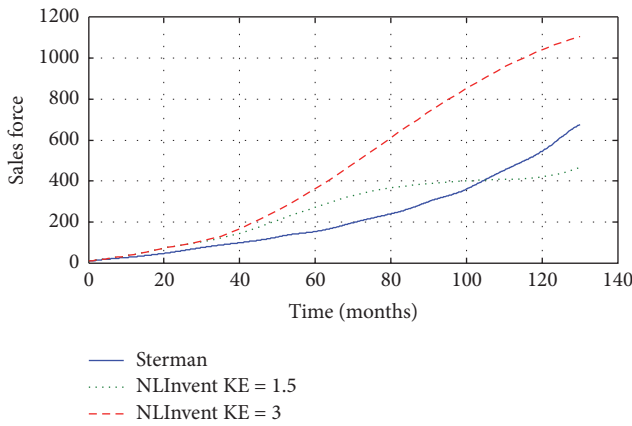

FIGURE 11: Sales force.

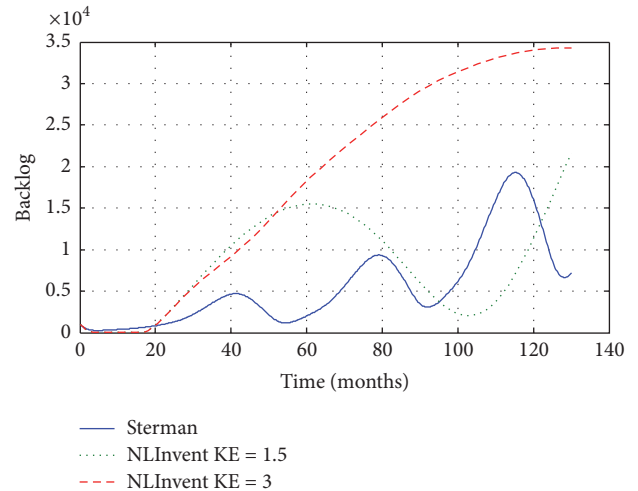

FIGURE 12: Backlog.

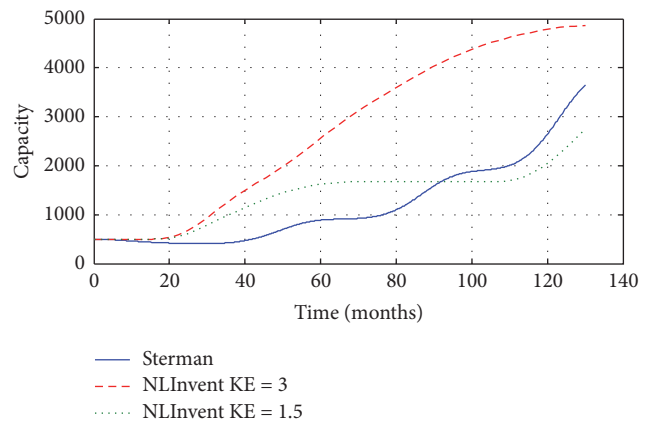

FIGURE 13: Capacity.

they are higher than those of Sterman for  $KE > 2$ . The new model (Figure 9) shows that the delivery delay rises to 8 months for the low gain  $KE = 1.5$ , whereas the Sterman model oscillates around 2–8 months, while the CS model with  $KE = 3$  is no worse than the Sterman model at just below 8 months. Capacity utilisation in the Sterman model is at 130% for considerable periods of time whereas the CS model runs at around 100% except at the start of the process, implying considerable overtime working of plant and staff. The value of utilisation means we would have to run with significant overtime with consequences for profitability. The peak value of sales force (Figure 11) is higher for  $KE = 3$  but for a larger sales it is the same. It is not clear why with a higher shipment rate the backlog (Figure 11) is also higher for the CS model. However matching the higher shipments and orders the required capacity is also higher in Figure 13.

Figure 14 shows that the revenue is higher for the whole period for  $KE = 3$  but generally for  $KE = 1.5$  in a similar amount. The large swings seen in the Sterman model are *not* seen in the CS PID controlled system. *The key problem for managers is that the large swings in performance are seen as being due to external factors but are in fact due entirely to the structure of the system for implementing decisions.*

The variation in capacity will be a severe problem to deal with as an investment issue. The system responses show a lower average and peak backlog. These excessive backlog and delivery delays will cause loss of customers and may result in them moving to a rival supplier. Shipment rates also vary greatly in the Sterman model creating logistic problems not present in the control system data.

The final curve shown in Figure 15 is the net stock in the inventory, not computed in the Sterman model. This shows a substantial excess stock problem after 60 months. A variable gain could be used by managers to control this parameter.

A step exogenous demand is made for the second set of results. This represents a sudden surge in customers, say from an advertising campaign. The picture (Figures 16–23) is not quite so clear now. The CS model (Figure 16) predicts a slower rise in shipment rate due to the delays in the inventory and forecasting elements. For  $KE = 3$  the shipment rate exceeds 650 units/month but then drops back to 600 after 65 months. The reduction in capacity predicted (Figure 17) by the Sterman model is not the same in the CS model; this would appear to be due to the dynamics in the original model not replicated in the CS model. Even for the CS model with

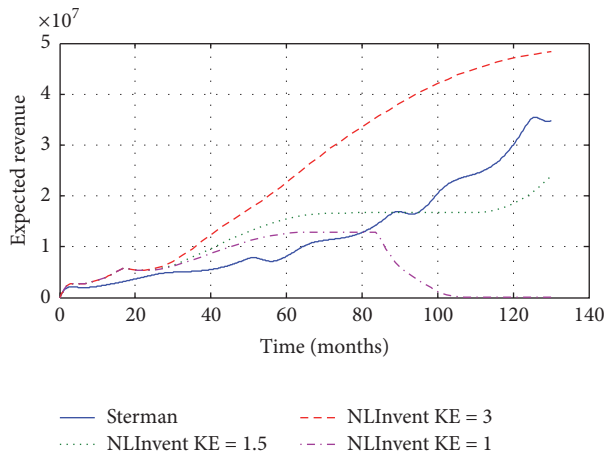

FIGURE 14: Expected revenue.

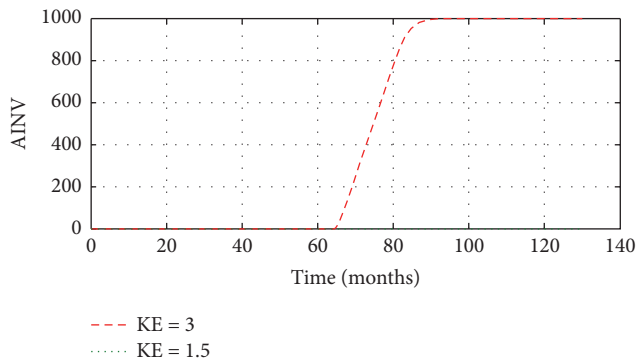

FIGURE 15: Net stock.

KE = 1.5 the capacity is increased more quickly than for the Sterman model, whereas the sales force required (Figure 18) is very close in the two models. The controlled system delivery delay can be made to reach zero for KE = 3 (Figure 19). The CS model has a higher peak backlog (Figure 20) but this reaches zero and the capacity utilisation required by the control system models is now not excessive being close to 100% but dropping to 92% since excess capacity is now in place. Apart from a small period around 10 months the inventory is close to zero unless the sales have crashed (KE = 1). The expected revenue is slightly greater for the case of KE = 3.

These results show that the CS model allows better use of the existing capacity and allows extra capacity to be scheduled faster than the SD model.

## 6. Discussion

The implications of the results of the simulations are now discussed with the possible implications for managers outlined.

The control system models agree with the general trends of the variables from the Sterman SD model, but they do not exhibit large oscillations present in the SD model. Responses are adjusted by altering the error gain. The main difference between the Sterman SD model and our model is the way

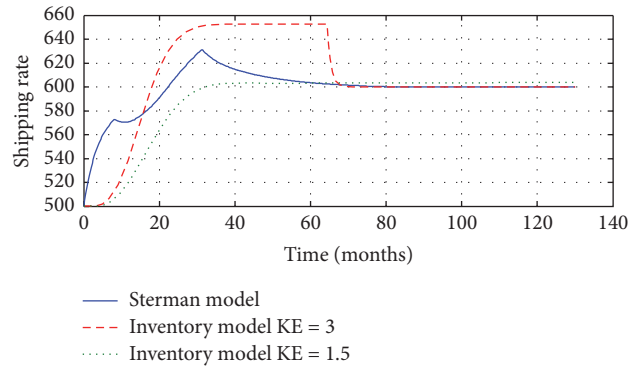

FIGURE 16: Exogenous step input shipment rate.

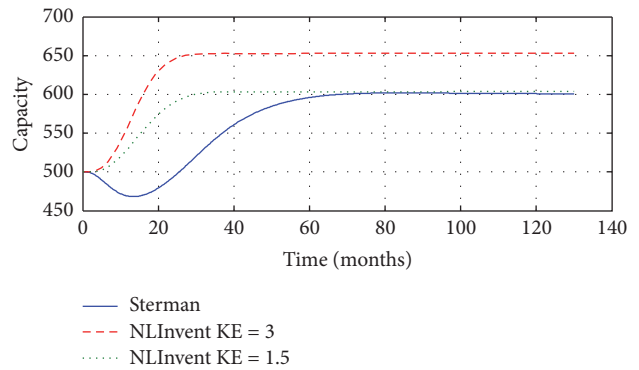

FIGURE 17: Exogenous input step capacity response.

the errors are computed and the nonlinear gains set in the Sterman model lookup tables. The loop structure and delays are the same except for the addition of the inventory subsystem loops in the CS model. It is clear therefore that the violent oscillations in capacity response which cause major business operational problems are due to the way the decisions are implemented. If a model can be used that does not exhibit these decision trends then a growth period for the company is more likely. These results also broadly agree with those of Yuan and Ashayeri [29]. The capacity augmentation behaviour under external input is similar to that described by Kamath and Roy [30]. Since no nonlinear limits are included in the CS model, its capacity utilisation is shown to be considerably higher in the Sterman SD model for the input conditions whereas peak utilisations are lower for the PID controlled system model.

Sterman [4] points out that his growth model shows far from optimal company performance. Growth is smaller than it could be. Actual company growth is smaller than it could be, and also growth of the firm is not smooth being subject to repeated “boom and bust” cycles. The analysis presented here suggests that these cycles are entirely due to the structure of the decision-making process incorporated into the firms’ management organisation. Sterman discusses at length the implication for the way managers operate in such an environment. Senior managers have the tendency to blame middle managers for weak leadership instead of examining the decision structures implemented in the firm. One cause

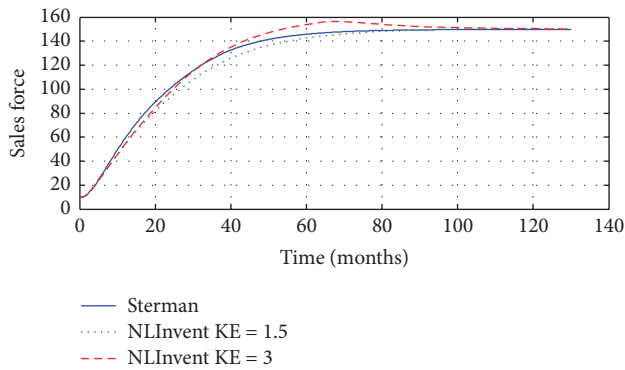

FIGURE 18: Step input sales force.

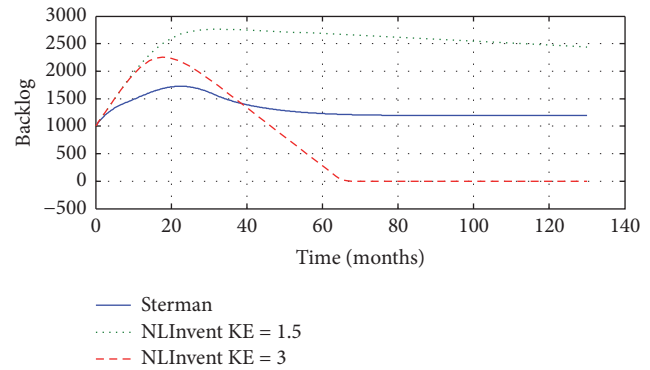

FIGURE 20: Step input effect on backlog response.

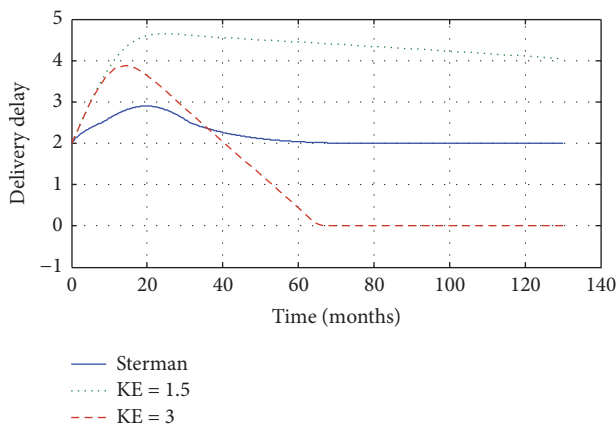

FIGURE 19: Step input delivery delay.

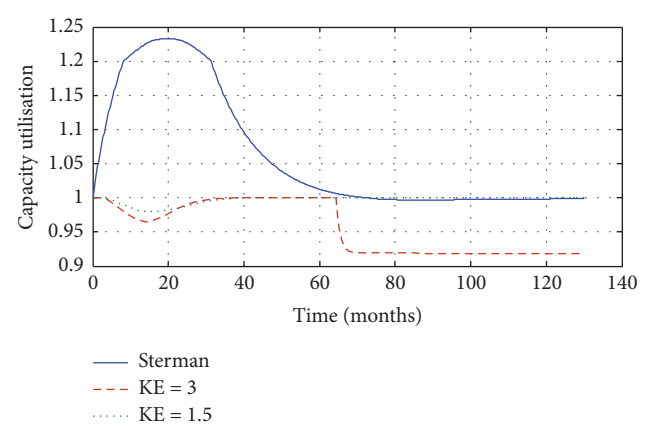

FIGURE 21: Step input on capacity utilisation.

is the inability of people to recognise the cause and effect when the events are not close together in time (and in another department!). If we change that process, reducing the time between event and action and making it easier to recognise an event by highlighting differences in performance as in the CS model presented here the causes of boom and bust cycles could be eliminated from internal mechanisms within the company. Those causes remaining will then be due to external event cycles in the economy as a whole.

## 7. Conclusions

Conclusions can be drawn from the responses of the two models and the work of other researchers.

Examination of the literature about capacity provision shows that the problem of capacity planning in high-tech and low-tech firms is a serious problem, exacerbated in high-tech products by the short lifetime. Existing industry data shows cyclic variation of capacity and investment to be present. SD analysis has shown this to be largely a company management structural effect rather than a demand problem.

Sterman created an SD model to examine the critical aspects of management decision-making after his investigation of feedback decisions in supply chains. His model shows unacceptably large cyclic variations in capacity. To reduce these effects a different decision process was devised

and a control engineering based (CS) model of the strategic modification of available capacity has been devised to include normal inventory control and delays to compare with the standard SD model of strategic capacity acquisition by Sterman.

This new model shows very clearly the effect the decision structure has on company performance by comparison with the model of existing companies from Sterman. It should be appreciated that nearly all SD models have embedded industry or company data in the nonlinear table functions used as they are often created for consultancy and are then specific to particular companies.

We have shown that an alteration to the decision process to make the recognition of the changes in capacity by implementing a simple difference between what is needed and what is already in place has a profound impact on the response to external demand.

The CS model does not use the nonlinear functions for decisions that the SD model uses, making it easier for managers to understand and recognise the process. When PID control is used, the performance is improved for many input conditions but a simple system using just the gain KE will have many of the overall advantages. The extreme booms and crashes predicted by the Sterman SD model are *not present* in this scenario from the model presented here. Hence internal decision processes can be eliminated being

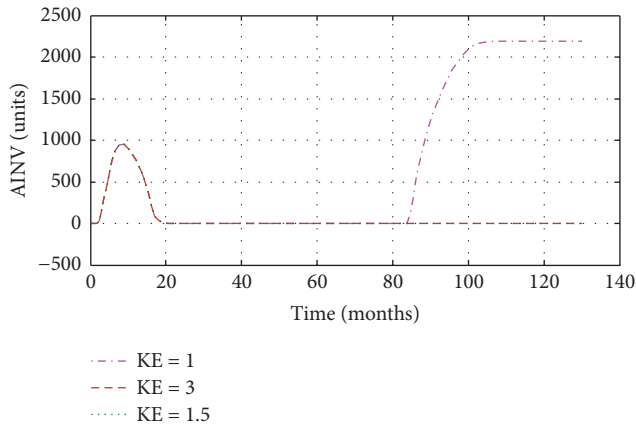

FIGURE 22: Net stock responses for step input in demand.

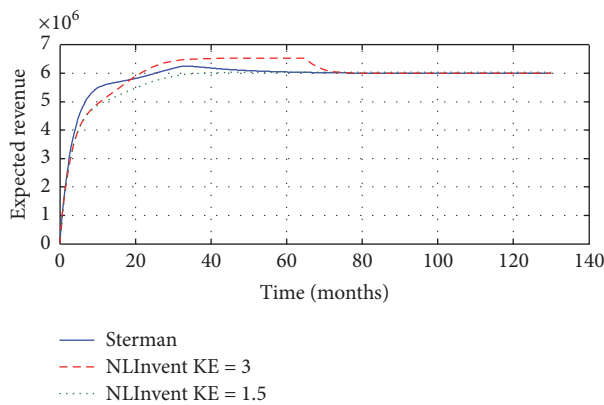

FIGURE 23: Order rate gain variation.

the cause of their company suffering “boom and bust” cycles. However, the gain of the capacity controller altered by the manager must be greater than 1 to avoid a company crash due to insufficient capacity.

Shipment rates occur later in the CS model for exogenous demand due to the inventory delays and the model shows that capacity utilisation is closer to 100% than that reported for the SD model. This is also true when a sudden external demand is made. Peak delivery delay and staff levels are similar to the PID controlled system model.

The control system model has

- (i) reduced variation in sales rates, capacity, delivery delay, and backlog,
- (ii) more consistent shipment rates,
- (iii) more consistent revenue rates.

The CS model is more generally applicable since it has limited data embedded in it that cannot be altered to suit a different company.

The model is able to provide management guidance at the strategic level and ease the decision-making process, enabling a choice of system parameters to give a specific performance.

The internal feedback mechanisms in the model allow managers to examine and rectify the effects on the company operations due to poor management decisions.

This model can easily be implemented as a spreadsheet for use by managers using only simple sales and other data.

The significant lesson from this work is that small changes in decisions can have large effects on the behaviour of the whole production/supply system. These changes together with making the decision at the correct time will determine the success of the strategy.

These models presented here are probably too simple to fully represent a particular company without adding extra details, but those parameters taken as constants need to be examined to determine their contribution to successful business operation. For example, the company goal for delivery delay could be made a dynamic variable.

## Future Work

The control system model allows the examination of the effects of adverse events such as production line machine failures or external commercial environmental factors, by simulation of random capacity disturbances. Future research will examine the effect of policy analysis on sales force productivity, the increasing use of internet marketing plus order systems, the freeing up of the concept of fixed delivery delays, and more rapid reconfiguration of production facilities. Since it is difficult to gain the trust of company managers to implement such processes without evidence of their effectiveness, this model could be developed into a product similar to the “Beer Game” as a management training aid to demonstrate the effectiveness of control of internal decision interactions.

## Abbreviations

BL:	Backlog (units)
b0:	Initial backlog = 1000
CAP:	Capacity (units)
Cgdd:	Company goal for delivery delay = 2 months
Cor:	Gain of sales force
CSR:	Cost per sales rep = \$8000
CU:	Capacity utilisation (fraction of capacity in use)
DCAP:	Desired capacity (units)
DD:	Delivery delay (weeks)
Dd:	Derivative gain for PID ~ 0.5
DDPC:	Delivery delay perceived by the company (weeks)
DP:	Desired production (units)
ECAP:	Extra capacity (units)
EEPDC:	Effect of expansion pressure on desired capacity
ER:	Expected revenue
ERRCAP:	Error in capacity
FRS:	Fraction of revenue to sales = 0.2
Ii:	Integral gain ~ 0.001
KE:	Control system proportional gain ~ 2.5

Kor:	Gain of backlog feedback
MPS:	Management planning system
MTDD:	Market target delivery delay = 2 months
NDD:	Normal delivery delay (company target) (weeks)
NSE:	Normal sales effectiveness = 10
OR:	Order rate (units/time)
ori:	Initial value of order rate
P:	Price of product = \$10000
PCB:	Printed circuit board
PEC:	Pressure to expand capacity
PID:	Proportional, Integral, and Derivative
PPC:	Production, Planning, and Control system
SALES:	Sales rate
s:	Laplace transform
SB:	Sales budget
SFAT:	Sales force adjustment time
SR:	Shipment rate (units/time)
$T_{cpd}$ :	Time to perceive capacity deficit = 3 months
$T_{cap}$ :	Time for capacity acquisition delay = 18 months
$T_{cpdd}$ :	Time for company to perceive delivery delay = 3 months
$T_{mdd}$ :	Time for market to perceive delivery delay = 12 months
$T_r$ :	Revenue reporting delay = 3 months
$T_{sf}$ :	Sales force adjustment time = 18 months.

## Competing Interests

The authors declare that they have no competing interests.

## References

- [1] J. D. Sterman and E. Mosekilde, *Business Cycles and Long Waves: A Behavioural Disequilibrium Perspective*, WP#3528-93-MSA, MIT Press, Cambridge, Mass, USA, 1993.
- [2] R. G. King and S. T. Rebelo, "Resuscitating real business cycles," in *Handbook of Macroeconomics*, J. B. Taylor and M. Woodford, Eds., North Holland, Amsterdam, The Netherlands, 1999.
- [3] European Commission, *European Business Cycle Indicators—2nd Quarter 2013*, 2013.
- [4] J. D. Sterman, *Business Dynamics*, McGraw-Hill, Boston, Mass, USA, 2000.
- [5] J. D. Sterman, "Modeling managerial behavior: misperceptions of feedback in a dynamic decision making experiment," *Management Science*, vol. 35, no. 3, pp. 321–339, 1989.
- [6] J. Lyneis, "System dynamics in business forecasting: A Case Study of the Commercial Jet Aircraft Industry," in *Proceedings of the 16th System Dynamics Conference*, Quebec, Canada, July 1998.
- [7] P. Langley, M. Paich, and J. D. Sterman, "Explaining capacity overshoot and price war: misperceptions of feedback in competitive growth markets," in *Proceedings of the 16th System Dynamics Conference*, Quebec, Canada, July 1998.
- [8] J. Forrester, "Market growth as influenced by capital investment," *Industrial Management Review*, vol. 9, no. 2, pp. 83–105, 1968.
- [9] O. Nord, *Growth of a New Product: Effects of Capacity Acquisition Policies*, MIT Press, Cambridge, Mass, USA, 1963.
- [10] J. D. Morecroft, "System dynamics: portraying bounded reality," in *Proceedings of the System Dynamics Research Conference*, The Institute on Man and Science, Rensselaerville, NY, USA, 1981.
- [11] J. D. Morecroft, "System dynamics: portraying bounded rationality," *Omega*, vol. 11, no. 2, pp. 131–142, 1983.
- [12] J. D. Morecroft, "Strategy support models," *Strategic Management Journal*, vol. 5, no. 3, pp. 215–229, 1984.
- [13] N. A. Bakke and R. Hellberg, "The challenges of capacity planning," *International Journal of Production Economics*, vol. 30-31, pp. 243–264, 1993.
- [14] F. M. Bass, "A new product growth for model consumer durables," *Management Science*, vol. 15, no. 5, pp. 215–227, 1969.
- [15] F. M. Bass, T. V. Krishnan, and D. C. Jain, "Why the bass model fits without decision variables," *Marketing Science*, vol. 13, no. 3, pp. 203–223, 1994.
- [16] R. Wild, *Production and Operations Management*, Cassell, London, UK, 5th edition, 1995.
- [17] H. A. Akkermans, P. Bogerd, E. Yücesan, and L. N. Van Wassenhove, "The impact of ERP on supply chain management: exploratory findings from a European Delphi study," *European Journal of Operational Research*, vol. 146, no. 2, pp. 284–301, 2003.
- [18] S. Karrabuk and D. Wu, "Coordinating Strategic Capacity Planning in the semi-conductor industry," Tech. Rep. 99T-11, Department of IMSE, Lehigh University, Bethlehem, Pa, USA, 1999.
- [19] S. D. Wu, M. Erkoç, and S. Karabuk, "Managing capacity in the high-tech industry: a review of literature," *The Engineering Economist*, vol. 50, no. 2, pp. 125–158, 2005.
- [20] A. Adl and J. Parvizian, "Drought and production capacity of meat: A system dynamics approach," in *Proceedings of the 27th System Dynamics Conference*, vol. 1, pp. 1–13, Albuquerque, NM, USA, July 2009.
- [21] O. Ceryan and Y. Koren, "Manufacturing capacity planning strategies," *CIRP Annals—Manufacturing Technology*, vol. 58, no. 1, pp. 403–406, 2009.
- [22] A. S. White and M. Censlive, "An alternative state-space representation for APVIOBPCS inventory systems," *Journal of Manufacturing Technology Management*, vol. 24, no. 4, pp. 588–614, 2013.
- [23] J. W. Forrester, *Industrial Dynamics*, MIT Press, Boston, Mass, USA, 1961.
- [24] B. J. Angerhofer and M. C. Angelides, "System dynamics modelling in supply chain management: research review," in *Proceedings of the 2000 Winter Simulation Conference*, pp. 342–351, New Jersey, NJ, USA, December 2000.
- [25] E. Suryani, "Dynamic simulation model of demand forecasting and capacity planning," in *Proceedings of the Annual Meeting of Science and Technology Studies (AMSTECS '11)*, Tokyo, Japan, March 2011.
- [26] S. Rajagopalan and J. M. Swaminathan, "A coordinated production planning model with capacity expansion and inventory management," *Management Science*, vol. 47, no. 11, pp. 1562–1580, 2001.
- [27] E. G. Anderson Jr., D. J. Morrice, and G. Lundeen, "The 'physics' of capacity and backlog management in service and custom manufacturing supply chains," *System Dynamics Review*, vol. 21, no. 3, pp. 217–247, 2005.
- [28] J. D. Sterman, R. Henderson, E. D. Beinhoeker, and L. I. Newman, "Getting big too fast: strategic dynamics with increasing returns and bounded rationality," *Management Science*, vol. 53, no. 4, pp. 683–696, 2007.

- [29] X. Yuan and J. Ashayeri, "Capacity expansion decision in supply chains: a control theory application," *International Journal of Computer Integrated Manufacturing*, vol. 22, no. 4, pp. 356–373, 2009.
- [30] N. B. Kamath and R. Roy, "Capacity augmentation of a supply chain for a short lifecycle product: a system dynamics framework," *European Journal of Operational Research*, vol. 179, no. 2, pp. 334–351, 2007.
- [31] D. Vlachos, P. Georgiadis, and E. Iakovou, "A system dynamics model for dynamic capacity planning of remanufacturing in closed-loop supply chains," *Computers & Operations Research*, vol. 34, no. 2, pp. 367–394, 2007.
- [32] N. Duffie, A. Chehade, and A. Athavale, "Control theoretical modeling of transient behavior of production planning and control: a review," *Procedia CIRP*, vol. 17, pp. 20–25, 2014.
- [33] H.-P. Wiendahl and J.-W. Breithaupt, "Automatic production control applying control theory," *International Journal of Production Economics*, vol. 63, no. 1, pp. 33–46, 2000.
- [34] P. Nyhuis, "Logistic production operating curves—basic model of the theory of logistic operating curves," *CIRP Annals—Manufacturing Technology*, vol. 55, no. 1, pp. 441–444, 2006.
- [35] F. M. Asi and A. G. Ulsoy, "Capacity management in reconfigurable manufacturing systems with stochastic market demand," in *Proceedings of the ASME International Mechanical Engineering Congress (IMEC '02)*, pp. 1562–1580, New Orleans, La, USA, November 2002.
- [36] S.-Y. Son, T. L. Olsen, and D. Yip-Hoi, "An approach to scalability and line balancing for reconfigurable manufacturing systems," *Integrated Manufacturing Systems*, vol. 12, no. 6–7, pp. 500–511, 2001.
- [37] J. A. Sharp and R. M. Henry, "Designing policies the ziegler nichols way," *Dynamica*, vol. 5, no. 2, pp. 79–94, 1979.
- [38] D. R. Towill and S. Yoon, "Some features common to inventory costs and process controller design," *Engineering Costs and Production Economics*, vol. 6, pp. 225–236, 1981.
- [39] A. S. White, "System Dynamics, inventory management and control theory," in *Proceedings of the 12th International Conference on CAD/CAM, Robotics and Factories of the Future*, pp. 691–696, 1996.
- [40] S. R. Orcun, R. Uzsoy, and K. Kempf, "Using system dynamics simulations to compare capacity models for production planning," in *Proceedings of the Winter Simulation Conference (WSC '06)*, pp. 1855–1862, IEEE, Monterey, Calif, USA, December 2006.
- [41] S. Elmasry, M. Shalaby, and M. Saleh, "A system dynamics simulation model for scalable-capacity manufacturing systems," in *Proceedings of the 30th International Systems Dynamics Conference*, St Galen, Switzerland, 2012, <https://www.system-dynamics.org/conferences/2012/proceed/index.html>.
- [42] P. Georgiadis, D. Vlachos, and G. Tagaras, "The impact of product lifecycle on capacity planning of closed-loop supply chains with remanufacturing," *Production and Operations Management*, vol. 15, no. 4, pp. 514–527, 2006.
- [43] P. Georgiadis and A. Politou, "Dynamic Drum-Buffer-Rope approach for production planning and control in capacitated flow-shop manufacturing systems," *Computers and Industrial Engineering*, vol. 65, no. 4, pp. 689–703, 2013.
- [44] P. Georgiadis, "An integrated system dynamics model for strategic capacity planning in closed-loop recycling networks: a dynamic analysis for the paper industry," *Simulation Modelling Practice and Theory*, vol. 32, pp. 116–137, 2013.
- [45] P. Georgiadis and E. Athanasiou, "Flexible long-term capacity planning in closed-loop supply chains with remanufacturing," *European Journal of Operational Research*, vol. 225, no. 1, pp. 44–58, 2013.
- [46] S. Cannella, E. Ciancimino, and A. C. Márquez, "Capacity constrained supply chains: a simulation study," *International Journal of Simulation and Process Modelling*, vol. 4, no. 2, pp. 139–147, 2008.
- [47] D. Packer, *Resource Acquisition in Corporate Growth*, MIT Press, Cambridge, Mass, USA, 1964.
- [48] M. Leibr, A. Größler, and M. Klein, "Understanding business cycles in the airline market," in *Proceedings of the 7th System Dynamics Conference*, Wellington, New Zealand, July 1999.
- [49] A. M. Deif and H. A. ElMaraghy, "A multiple performance analysis of market-capacity integration policies," *International Journal of Manufacturing Research*, vol. 6, no. 3, pp. 191–214, 2011.
- [50] V. L. N. Spiegler, *Designing supply chains resilient to nonlinear system dynamics [Ph.D. thesis]*, Cardiff University, Cardiff, Wales, 2013.
- [51] E. W. Diehl, *Effects of feedback structure on dynamic decision making [Ph.D. thesis]*, Sloan School of Management, MIT, New York, NY, USA, 1992.
- [52] A. S. White and M. Censlive, "A new control model for strategic capacity Acquisition," in *Proceedings of the Advances in Manufacturing Technology XXV, 9th International Conference on Manufacturing Research*, D. K. Harrison, B. M. Wood, and D. Evans, Eds., vol. 97, pp. 157–163, Glasgow, UK, 2011.
- [53] A. S. White and M. Censlive, "Observations on control models for reconfigurable manufacture," in *Advances in Manufacturing Technology XXV, Ninth International Conference on Manufacturing Research*, D. K. Harrison, B. M. Wood, and D. Evans, Eds., pp. 163–170, Glasgow Caledonian University, Glasgow, UK, 2011.





**Hindawi**

Submit your manuscripts at  
<http://www.hindawi.com>

