

Middlesex University Research Repository:

an open access repository of
Middlesex University research

<http://eprints.mdx.ac.uk>

Rice-Hills, Ann A, 2006.
Signal transduction mechanisms of the type I interferons in the human
endometrium.
Available from Middlesex University's Research Repository.

Copyright:

Middlesex University Research Repository makes the University's research available electronically.

Copyright and moral rights to this thesis/research project are retained by the author and/or other copyright owners. The work is supplied on the understanding that any use for commercial gain is strictly forbidden. A copy may be downloaded for personal, non-commercial, research or study without prior permission and without charge. Any use of the thesis/research project for private study or research must be properly acknowledged with reference to the work's full bibliographic details.

This thesis/research project may not be reproduced in any format or medium, or extensive quotations taken from it, or its content changed in any way, without first obtaining permission in writing from the copyright holder(s).

If you believe that any material held in the repository infringes copyright law, please contact the Repository Team at Middlesex University via the following email address:
eprints@mdx.ac.uk

The item will be removed from the repository while any claim is being investigated.

**Signal Transduction Mechanisms of the Type I
Interferons in the Human Endometrium**

Anne A Rice-Hills

**A thesis submitted for the degree of Doctor of Philosophy at Middlesex
University**

School of Health and Social Science, Middlesex University

ABSTRACT

Unlike humans, the primary signal for maternal recognition of pregnancy in ruminants is the Type I interferon (IFN) IFN τ . IFN τ is produced by the conceptus and acts upon the endometrium where it inhibits the production of prostaglandin F $_{2\alpha}$ and subsequent luteolysis of the corpus luteum. It is difficult to establish what precise role interferon-like signalling might play in human reproduction due to ethical barriers. However, indirect investigations are possible by *in vitro* investigation of human endometrial response to Type I IFN stimulation.

Type I IFNs (α , β and τ) activate a common tyrosine kinase signalling pathway involving the Janus kinase (JAK) and signal transducer and activator of transcription (STAT) proteins. However, the Type I IFNs elicit different cellular responses.

The aim of this thesis is to establish that, whilst it is known that the Type I IFNs trigger the JAK/STAT activation pathway, there is a simultaneous activation of different phospholipase pathways which determines the specificity of the response. This hypothesis was investigated using human endometrial tissue which is known to respond to Type I IFNs.

Long-term primary human endometrial cell cultures were established from tissue taken from the proliferative and secretory phases of the menstrual cycle. Cell function and viability were determined by measuring placental proteins and cytokines. ^{33}P labelled endometrial cells exposed to IFNs α and τ showed hydrolysis of phosphatidylinositol 4,5-bisphosphate (PIP $_2$) with corresponding production of diacylglycerol (DAG). IFN α and IFN τ also stimulated hydrolysis of phosphatidylinositol-4-phosphate (PIP). These IFNs did not demonstrate activation of any other phospholipase. There was no phospholipid turnover via any phospholipase

in response to IFN β . Using immunoprecipitation, SDS-PAGE and Western blotting it was possible to show the presence of phosphorylated STAT1 α in unstimulated endometrial cells. In response to stimulation by IFN α and β there was an increase in phosphorylated STAT1 α , STAT2 and Tyk2 (a member of the Janus kinase family). In contrast, IFN τ activated the phosphorylation of Tyk2 but not STAT1 α or STAT2. There was no stimulation of JAK1 phosphorylation by any of the IFNs. In summary, Type I IFNs α , β and τ each elicit a different pattern of signal transduction response in cultured human endometrial cells, not only via the JAK/STAT pathway but also via phospholipase activation.

The ability of IFN τ to stimulate a signalling pathway, distinct from that of IFN α and β is sufficient circumstantial evidence to suggest that at least a residual signalling pathway for IFN τ exists in the human endometrium and further investigation is warranted.

ATTRIBUTION

I declare that this thesis has been composed by myself and the work of which it is a record has been principally performed by myself.

Signed _____

Anne Rice-Hills

Date _____

I declare that the conditions of the ordinance and regulations (PhD) have been fulfilled.

Signed _____

Professor Ray K Iles

Date _____

ACKNOWLEDGEMENTS

The studies reported in this thesis would not have been possible without help from friends and colleagues in the Departments of Reproductive Physiology, Obstetrics and Gynaecology and Histopathology at St Bartholomew's Hospital.

I am indebted to Dr Sheryl Homa for having given me the opportunity to work on this project and for being my co-supervisor with Professor Tim Chard. I would like to thank her for being a support both inside and outside work, for supplying me with cups of tea and biscuits at our meetings but most of all for guiding and teaching me in the art of scientific research.

The completion of this thesis would not have been possible without the encouragement, forbearance and determination of Professor Ray Iles who agreed to take over the co-supervision of this thesis on the retirement of Professor Chard.

I would like to thank Dr David Lowe and Suzanne Jordan for introducing me to, and assisting me with, various histopathological techniques (and the chair with 3 legs).

Many thanks go to everyone, but in particular Frank [], Peebs, Lionel, Cathy, George, Eileen, Nicki and Andy, in Repro Phys for their help, advice, criticism and sense of humour during the gestation of this thesis.

A very special mention must go to Frank [], my husband, who has supported me, advised me and encouraged me selflessly with patience beyond the call of duty.

Finally, and most particularly, my special gratitude to the late Professor Tim Chard who I never got to thank for appointing me to the post of clinical biochemist in Reproductive Physiology 31 years ago. I shall be forever grateful to him for making Repro Phys the very best place to work both scientifically and socially.

DEDICATION

This thesis is dedicated to
my sons Samuel and Alexander
my husband Frank
my brother David

PUBLISHED ABSTRACTS

Rice A, Homa S, Bosmans E and Chard T (1997) The production of LIF, IL-6, IFN γ , TNF α , CC16, HGF and PP14 by long-term primary cultures of human endometrial cells. *J Br Fert Soc* 2:7.

Rice A and Homa S (1997) Phospholipid pathways may confer specificity of the response of human endometrial cells to Type I interferons. *Hum Repro* 12:216.

Oral presentations arising from this work

The production of LIF, IL-6, IFN γ , TNF α , CC16, HGF and PP14 by long-term primary cultures of human endometrial cells.

December 1996, British Fertility Society Conference, Dundee

Poster presentations arising from this work

Phospholipid pathways may confer specificity of the response of human endometrial cells to Type I interferons.

June 1997, ESHRE, Edinburgh

CONTENTS

Title page.....	i
Abstract	ii
Attribution	iv
Acknowledgements	v
Dedication	vi
Published Abstracts	vii
Contents.....	viii
List of Figures	xvii
List of Tables.....	xx
List of Abbreviations.....	xxi
<u>CHAPTER 1: Introduction</u>	1
1.1 The menstrual cycle and the role of the endometrium.....	2
1.2 Implantation	7
1.3 Maternal recognition of pregnancy	12
1.4 Interferons	14
1.5 Interferons and early pregnancy.....	19
1.6 The mechanism of action of interferon	26
1.7 Cell signalling	32
1.7.1 Signalling through receptor tyrosine kinases	35
1.7.2 Signalling through cytokine class I and II receptors.....	35
1.7.3 Signalling through G-protein coupled receptors.....	36
1.8 Aims of the thesis.....	38

CHAPTER 2: Materials and methods	39
2.1 Major equipment	40
2.2 Minor equipment	42
2.3 Reagents	43
2.3.1 Primary cell culture	44
2.3.2 Immunoassays	45
2.3.3 Immunocytochemistry and immunohistochemistry	46
2.3.4 Thin layer chromatography	46
2.3.5 SDS-PAGE and Western blotting	47
2.4 Standard solutions	48
2.4.1 Primary cell culture	48
2.4.1.1 <i>Cell culture medium</i>	48
2.4.1.2 <i>Cell culture buffer</i>	48
2.4.2 Immunoassays	48
2.4.2.1 <i>50mM phosphate buffered saline</i>	48
2.4.2.2 <i>IGFBP-1 assay buffer</i>	48
2.4.2.3 <i>PP14 assay buffer</i>	48
2.4.2.4 <i>7.5% and 15% PEG solutions</i>	49
2.4.3 Immunocytochemistry and immunohistochemistry	49
2.4.3.1 <i>50mM Tris buffered saline pH 7.4</i>	49
2.4.3.2 <i>1% paraformaldehyde with 0.1% gluteraldehyde solution</i>	49
2.4.4 Thin layer chromatography	49
2.4.4.1 <i>Concentrated chromic acid wash</i>	49
2.4.4.2 <i>Solutions for the extraction of total lipids</i>	49

2.4.4.3	<i>Solutions for the extraction of total lipids with increased extraction of polar phospholipids</i>	49
2.4.4.4	<i>Total lipid TLC solvent system</i>	49
2.4.4.5	<i>Potassium oxalate solution</i>	50
2.4.4.6	<i>Phosphoinositide TLC solvent system</i>	50
2.4.4.7	<i>Glycerol TLC solvent system</i>	50
2.4.5	SDS-PAGE.....	50
2.4.5.1	<i>Lysis buffers</i>	50
2.4.5.2	<i>SDS-PAGE buffers</i>	51
2.4.5.3	<i>SDS-PAGE gels</i>	52
2.4.6	Western blotting.....	52
2.4.6.1	<i>Western blotting buffers</i>	52
2.5	General methods.....	53
2.5.1	Primary cell culture	53
2.5.2	Immunoassays	54
2.5.2.1	<i>Radioimmunoassay</i>	54
2.5.2.2	<i>Enzyme-linked immunosorbent assay</i>	55
2.5.3	Thin layer chromatography	56
2.5.4	SDS-PAGE.....	57
2.5.5	Western blotting	60
2.6	Statistical analysis	61

Chapter 3: The establishment and characterisation of primary endometrial cell

<u>culture</u>	62
3.1 Introduction	63
3.1.1 Placental proteins	66
3.1.1.1 <i>Placental protein 14: epithelial cell marker</i>	66
3.1.1.2 <i>Insulin-like growth factor binding protein-1: a stromal cell marker</i>	67
3.2 Methods.....	68
3.2.1 Collection of endometrial tissue.....	68
3.2.2 Preparation and culture of endometrial cells.....	68
3.2.3 Cell number determination.....	70
3.2.4 Cell viability	70
3.2.5 Cell characterisation.....	71
3.2.5.1 <i>Cell morphology</i>	71
3.2.5.2 <i>Immunocytochemistry</i>	71
3.2.6 Cell function.....	72
3.2.6.1 <i>Radioimmunoassay for PP14</i>	72
3.2.6.2 <i>Radioimmunoassay for IGFBP-1</i>	73
3.3 Statistical analysis	74
3.4 Results	74
3.4.1 Cell culture	74
3.4.2 Cell viability.....	74
3.4.3 Cell morphology.....	74
3.4.4 Cell function.....	75
3.4.4.1 <i>PP14</i>	78

3.4.4.2	<i>IGFBP-1</i>	78
3.5	Discussion	81
	<u>Chapter 4: Cytokine production by endometrial cell cultures</u>	83
4.1	Introduction	84
4.1.1	Cytokines.....	84
4.1.1.1	<i>Leukaemia inhibitory factor (LIF)</i>	84
4.1.1.2	<i>Interleukin 6</i>	85
4.1.1.3	<i>Tumour necrosis factor α</i>	85
4.1.1.4	<i>Hepatocyte growth factor</i>	86
4.1.1.5	<i>Interferon γ</i>	87
4.2	Methods.....	88
4.2.1	Cytokine enzyme immunoassays	88
4.3	Statistical analysis	89
4.4	Results.....	89
4.4.1	LIF	89
4.4.2	IL-6.....	90
4.4.3	HGF.....	90
4.4.4	TNF α and IFN γ	90
4.5	Discussion	95
	<u>Chapter 5: Endometrial cell response to IFNα</u>	98
5.1	Introduction	99
5.2	Methods.....	102
5.3	Results.....	103
5.4	Discussion	106

Chapter 6: Localisation of a Type I interferon receptor on endometrial cells in

<u>culture</u>	107
6.1 Introduction.....	108
6.1.1 Immunohistochemistry.....	108
6.1.2 Binding of ¹²⁵ I-IFN α	109
6.1.3 Electron microscopy.....	109
6.2 Methods.....	109
6.2.1 Immunohistochemistry.....	109
6.2.2 ¹²⁵ I-IFN α method.....	110
6.2.3 Electron microscopy.....	111
6.3 Results.....	112
6.3.1 Immunohistochemistry.....	112
6.3.2 ¹²⁵ I-IFN α binding	112
6.3.3 Electron microscopy.....	113
6.4 Discussion.....	117

Chapter 7: Phospholipid turnover following Type I interferon stimulation

7.1 Introduction.....	119
7.2 Methods.....	128
7.2.1 Extraction of lipids.....	128
7.2.1.1 <i>Extraction of total lipids by the method of Bligh and Dyer</i> <i>(1959)</i>	128
7.2.1.2 <i>Extraction of total lipids with an increased extraction of the</i> <i>polar phospholipids by the method of Shukla and Hanahan</i> <i>(1984)</i>	129
7.2.2 Thin layer chromatography methods	129

7.2.2.1	TLC for total lipids.....	129
7.2.2.2	TLC for phosphoinositides.....	130
7.2.3	Cell viability in phosphate-free medium.....	130
7.2.4	Equilibration of [³³ P] orthophosphate uptake by endometrial cells.....	132
7.2.5	Phospholipid turnover following IFN stimulation.....	139
7.2.6	Equilibration of [³ H] glycerol uptake in endometrial cells.....	139
7.2.7	Measurement of diacylglycerol levels following IFN stimulation ..	140
7.3	Statistical analysis.....	140
7.4	Results.....	141
7.4.1	Cell viability in phosphate-free medium.....	141
7.4.2	Equilibration of [³³ P] orthophosphate uptake by endometrial cells.....	142
7.4.3	Phospholipid turnover following stimulation by IFN α	144
7.4.4	Phospholipid turnover following stimulation by IFN β	144
7.4.5	Phospholipid turnover following stimulation by IFN τ	147
7.4.6	Equilibration of [³ H] glycerol uptake in endometrial cells.....	152
7.4.7	DAG turnover following stimulation by Type I interferons.....	152
7.5	Discussion.....	156
7.5.1	The response to IFN α	156
7.5.2	The response to IFN β	157
7.5.3	The response to IFN τ	159
<u>Chapter 8: Determination of the presence of JAK and STAT proteins in</u>		
<u>unstimulated endometrial cells</u>		
8.1	Introduction.....	163
8.1.1	The classic IFN signalling pathway.....	163
8.2	Methods.....	171

8.2.1	Immunoprecipitation of the JAK and STAT proteins.....	171
8.2.2	SDS-PAGE.....	172
8.2.3	Western blotting.....	173
8.2.4	Detection of proteins by enhanced chemiluminescence (ECL)	174
8.3	Results.....	175
8.4	Discussion	178
<u>Chapter 9: Phosphorylation of JAK and STAT proteins following Type I</u>		
<u>interferon stimulation in endometrial cells</u>		
		179
9.1	Introduction.....	180
9.2	Methods.....	180
9.3	Results.....	181
9.3.1	Phosphorylation status of JAK and STAT proteins in unstimulated endometrial cells	181
9.3.2	Stimulation by IFN α	181
9.3.3	Stimulation by IFN β	183
9.3.4	Stimulation by IFN τ	183
9.4	Discussion	186
<u>Chapter 10: Summary and general discussion</u>		
		192
10.1	Objective of this thesis.....	193
10.2	Summary of principle findings.....	193
10.2.1	Primary human endometrial cell culture	193
10.2.2	IFN α/β receptor	194
10.2.3	Phospholipid turnover in endometrial cells in response to Type I IFN stimulation.....	195

10.2.4 JAK and STAT proteins in endometrial cells and their phosphorylation following Type I IFN stimulation	196
10.3 General discussion	196
10.4 Future directions.....	201
10.5 Conclusions.....	203
<u>References</u>	204

LIST OF FIGURES

Figure 1.1	The human female reproductive system.	2
Figure 1.2	The human proliferative endometrium.	3
Figure 1.3	Diagrammatic representation of the menstrual cycle.	6
Figure 1.4	Blastocyst apposition and adhesion.	9
Figure 1.5	Blastocyst implantation.	10
Figure 1.6	Processes involved in maintaining pregnancy.	11
Figure 1.7	The role on IFN τ	13
Figure 1.8	Wireplots of IFN α and IFN β	16
Figure 1.9	Amino acid sequence of IFN α and IFN τ	21
Figure 1.10	Wireplots of IFN α and IFN τ	22
Figure 2.1	Primary cell culture technique.	54
Figure 2.2	The principle of radioimmunoassay.	55
Figure 2.3	Operation of discontinuous SDS-PAGE.	59
Figure 2.4	Method of protein transfer.	60
Figure 2.5	The principle of Western immunoblotting and ECL detection.	61
Figure 3.1	The human proliferative endometrium.	64
Figure 3.2	Hormonal and endometrial changes during the menstrual cycle.	65
Figure 3.3	Trypan blue uptake.	75
Figure 3.4	Primary human epithelial and stromal endometrial cells.	76
Figure 3.5	Anti-cytokeratin & anti-vimentin staining of human endometrial cells.	77
Figure 3.6	<i>In vitro</i> concentrations of PP14.	80

Figure 3.7	<i>In vitro</i> concentrations of IGFBP-1.....	80
Figure 4.1	<i>In vitro</i> concentrations of LIF.....	92
Figure 4.2	<i>In vitro</i> concentrations of IL-6.....	93
Figure 4.3	<i>In vitro</i> concentrations of HGF.....	94
Figure 5.1	The Type I IFN receptor.....	100
Figure 5.2	Primary human endometrial cells cultured in the absence and presence of IFN α	104
Figure 5.3	The effect of IFN α concentration on cell number.....	105
Figure 6.1	Immunostaining with polyclonal IFN α / β R antibody.....	114
Figure 6.2	Immunostaining with monoclonal IFN α R antibody.....	115
Figure 6.3	Autoradiograph of cells incubated with 125 I IFN α	116
Figure 7.1	The formation of PIP $_2$ from its precursor.....	120
Figure 7.2	The inositol-lipid cycles.....	122
Figure 7.3	Transmembrane signalling by phospholipid hydrolysis.....	123
Figure 7.4	The sites of action of the phospholipases A $_2$, C and D.....	125
Figure 7.5	TLC using silica gel 60 and Whatman LHP-K plates.....	131
Figure 7.6	Time course of 33 P uptake.....	135
Figure 7.7	The decay profile of 33 P.....	138
Figure 7.8	Uptake of [33 P] orthophosphate into phospholipids.....	143
Figure 7.9	Endometrial cell response to IFN α	146
Figure 7.10	Endometrial cell response to IFN β	149

Figure 7.11 Endometrial cell response to IFN τ	151
Figure 7.12 Uptake of [3 H] glycerol into DAG.....	153
Figure 7.13 Endometrial cell response to IFNs α , β and τ	155
Figure 8.1 The mechanism of Type I IFN signalling.....	167
Figure 8.2 Presence of JAK1, Tyk2, STAT1 α and STAT2 in endometrial cells...	176
Figure 8.3 Ferguson plot of molecular weight against distance migrated.	177
Figure 9.1 STAT1 α is constitutively phosphorylated in unstimulated cells.....	182
Figure 9.2 Phosphorylation of JAK1, Tyk2, STAT1 α and STAT2.	185

LIST OF TABLES

Table 1.1	Factors associated with implantation	8
Table 1.2	Biological effects of IFNs	18
Table 1.3	Interferon production in human pregnancy.....	24
Table 1.4	Interferon in animal pregnancy	25
Table 3.1	<i>In vitro</i> concentrations of PP14 and IGFBP-1	79
Table 4.1	<i>In vitro</i> concentrations of LIF, IL-6 and HGF	91
Table 5.1	Number of endometrial cells cultured in the presence of increasing concentrations of IFN α	105
Table 7.1	Counting [33 P] on three channels of a scintillation counter.....	136
Table 7.2	Endometrial cell viability	141
Table 7.3	IFN α induced changes in endometrial cell phospholipids with time	145
Table 7.4	IFN β induced changes in endometrial cell phospholipids with time	148
Table 7.5	IFN τ induced changes in endometrial cell phospholipids with time	150
Table 7.6	IFN α , β and τ induced changes in endometrial cell DAG with time.....	154
Table 9.1	Summary of endometrial cell response by Type I IFNs.	184

List of Abbreviations

°C	Degrees Centigrade
AA	Arachidonic acid
BSA	Bovine serum albumin
bTP-1	Bovine trophoblast protein-1
C	Carbon
Ca	Calcium
Ci	Curie
cm	Centimetre
cpm	counts per minute
Cys	Cysteine
DAB	Diaminobenzidine
DAG	Diacylglycerol
DMEM	Dulbecco's modified Eagles medium
DNA	Deoxyribonucleic acid
ECL	Enhanced chemiluminescence
EDTA	Ethylene-diamine tetra-acetic acid
ELISA	Enzyme-linked immunosorbent assay
FSH	Follicle stimulating hormone
g	Gram
GAS	γ activation site
G-protein	Guanine nucleotide binding protein
H	Hydrogen
hCG	Human chorionic gonadotrophin

HCl	hydrochloric acid
HGF	Hepatocyte growth factor
hr	hour
IFN α , β and τ	interferon α , β and τ
IGFBP-1	Insulin-like growth factor binding protein-1
IL	Interleukin
IP ₃	inositol 1,4,5-trisphosphate
ISGF	Interferon-stimulated gene factor
ISRE	Interferon-stimulated response element
JAK	Janus kinase
K _a	affinity constant
kDa	kiloDaltons
KeV	Kiloelectron volts
L	Litre
LH	Luteinising hormone
LIF	Leukaemia inhibitory factor
LPC	Lysophosphatidylcholine
mg	milligram
mL	millilitre
mM	millimolar
N	Nitrogen
NK	Natural killer
oTP-1	Ovine trophoblast protein-1
P	Phosphorus
PA	Phosphatidic acid

PAGE	Polyacrylamide gel electrophoresis
PBS	Phosphate buffered saline
PC	Phosphatidylcholine
PVDF	Polyvinylidene fluoride
PE	Phosphatidylethanolamine
PG	Prostaglandin
PI	Phosphatidylinositol
PIP	Phosphatidyl 4-phosphate
PIP ₂	Phosphatidylinositol 4,5-bisphosphate
PKC	Protein kinase C
PLA, PLC and PLD	Phospholipase A, C and D
PP14	Placental protein 14
PS	Phosphatidylserine
pTP-1	Porcine trophoblast protein-1
RIA	Radioimmunoassay
RNA	Ribonucleic acid
RT	room temperature
SDS	Sodium dodecyl sulphate
SEM	Standard error of the mean
SH	Src homology
STAT	Signal transducers and activators of transcription
TBST	Tris buffered saline with Tween 20
TLC	Thin layer chromatography
TMB	tetramethylbenzidine
TNF	Tumour necrosis factor

Tyk 2

member of the JAK family of kinases

CHAPTER 1

INTRODUCTION

1.1 The menstrual cycle and the role of the endometrium

One of the most important structures of the human female reproductive system is the uterus (Figure 1.1).

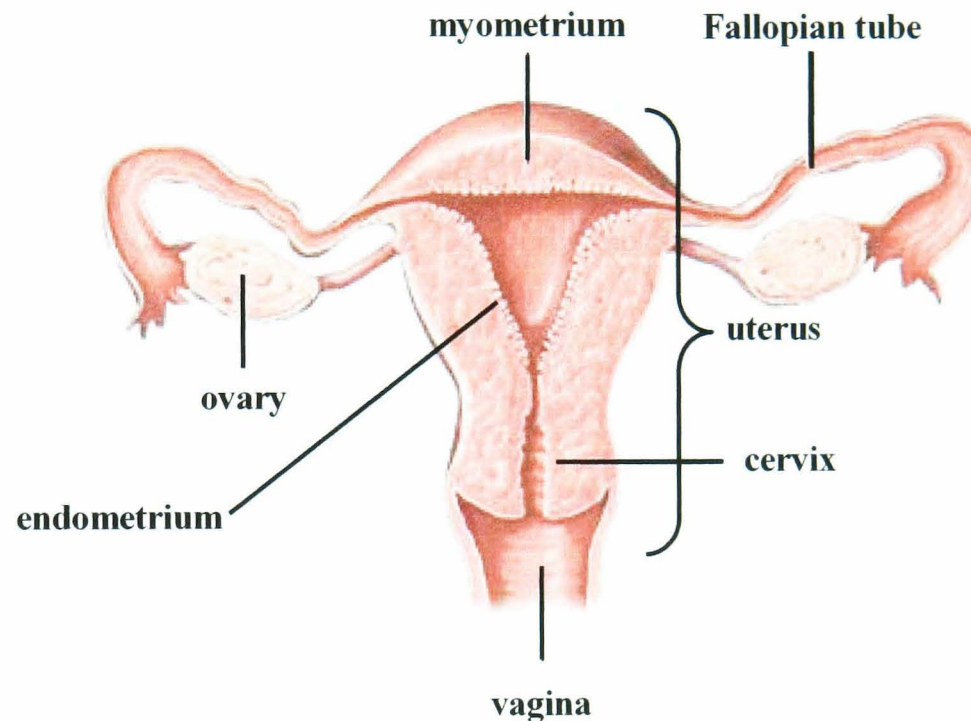

Figure 1.1 The human female reproductive system. Adapted from www.nlm.nih.gov (2006).

The uterus is a pear-shaped organ 7.5 cm long, 5 cm wide and 2.5 cm deep. The lumen, the cavity of the uterus, is connected to the peritoneal cavity by Fallopian tubes at the top and to the exterior by the vagina below. At the ends of the Fallopian tubes lie the ovaries. The wall of the lumen is 1-2 cm thick. This wall is comprised

of two layers – the myometrium and the endometrium. The myometrium makes up the bulk of the uterine wall and is made up of bundles of smooth muscle fibres held together by connective tissue.

The endometrium is the constantly changing layer of the uterine lumen. The change is due to the effects of ovarian hormones, oestrogen and progesterone. At menstruation most of the endometrium breaks down and is shed leaving a layer about 0.5 mm thick of residual basement endometrium. Regeneration takes place followed by the proliferative phase due to the influence of oestrogen. By mid-cycle the endometrium attains a thickness of 2-3 mm. It is lined by columnar epithelial cells which invaginate into the endometrial stroma at regular intervals to form straight or slightly curved glands with a narrow lumen (Figure 1.2).

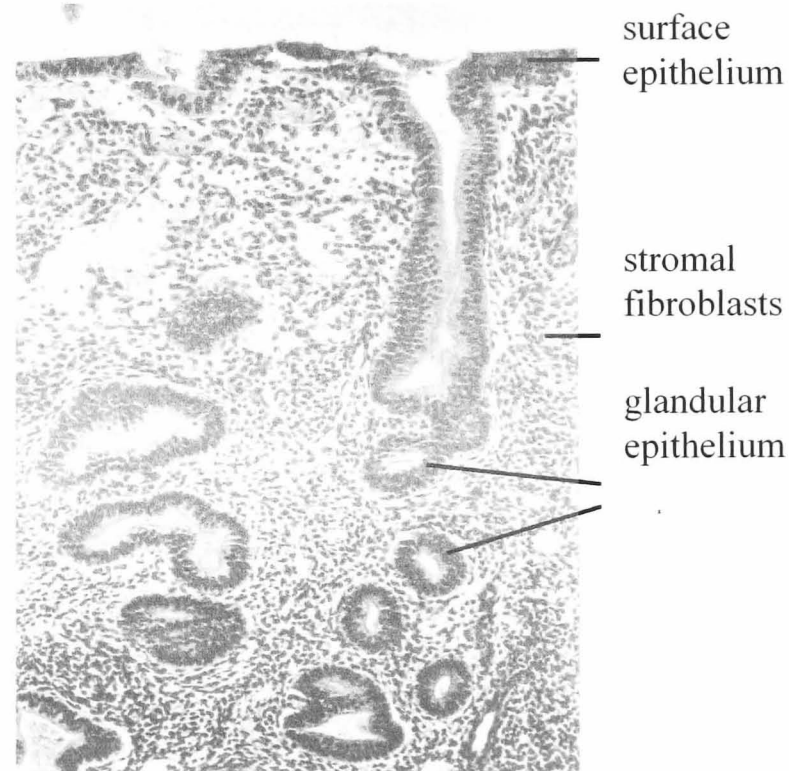

Figure 1.2 The human proliferative endometrium showing stromal and epithelial cells. From Llewellyn-Jones (1978).

The tips of the glands reach the myometrium and remain after menstruation giving rise to the pars basalis from which re-epithelialisation may occur. The stroma consists of a reticular connective tissue rich in spindle-shaped nuclei. In the second half of the menstrual cycle progesterone, from the corpus luteum, leads to further thickening of the endometrium by 5-6mm and this is known as the secretory phase. The glands become increasingly elongated, tortuous and sacculated. Fat, protein and glycogen accumulate in the epithelial cells and displace their nuclei nearer to the cell surface. The secretory products of these cells then appear in the lumina of the glands. Three layers of endometrium now become distinguishable. The zona compacta is thin and superficial; the glands are straight and narrow and surrounded by oedematous stroma. The middle layer, zona spongiosa, occupies most of the mucosa; the glands are tortuous, dilated and sacculated and the spiral arteries are in abundance. The deepest narrow layer, zona basalis, which is adjacent to the myometrium remains virtually unaltered.

During menstruation, ischaemia (insufficient flow of blood) is followed by necrosis, haemorrhage and discharge of the detached portions of endometrium. Menstruation and repair probably occur simultaneously in different parts of the endometrium. If pregnancy occurs menstruation does not take place and the endometrium becomes even thicker, 10-12 mm, and the stromal cells are converted into large glycogen-laden decidual cells. During pregnancy the endometrium is called the decidua.

The changes in endometrial morphology and cellular functions throughout the menstrual cycle are strongly influenced by oestrogen and progesterone and these are indirectly controlled by the gonadotrophic hormones; follicle stimulating hormone (FSH) and luteinising hormone (LH).

Under the influence of FSH, released by the pituitary gland, several Graafian follicles develop in the ovary. One follicle will develop more than the others and it is from this follicle that the ovum will be released. The stimulated follicles synthesise and secrete the oestrogen, oestradiol 17β . This secretion is important in the regeneration of the endometrium after menstruation and the initiation of the proliferative phase of the menstrual cycle. The serum increase in oestradiol 17β causes a positive feedback on the hypothalamus and pituitary which results in a sudden increase in the release of LH. This LH surge causes the release of the ovum on about day 14 of the menstrual cycle. The follicle, which had contained the ovum, collapses and its cells are altered, under the continuing influence of LH, to synthesise oestradiol 17β and progesterone. The addition of progesterone activity to the oestrogen effect is to convert the proliferative phase endometrium into a secretory one.

The follicular cells become luteinised and the collapsed follicle is called the corpus luteum. In the absence of fertilisation, the corpus luteum regresses, the levels of oestrogen and progesterone fall and the endometrium can no longer be maintained. Shrinkage occurs when there is constriction of the spiral arteries leading to necrosis and bleeding. The deeper basal layers of the endometrium are able to maintain a blood supply but the upper layers break down and are shed as menstrual flow (Figure 1.3).

If fertilisation occurs it does so in the Fallopian tube within 24-48 hours after ovulation. The initial stages of development from fertilised ovum to morula (a mass of 12-16 cells) occurs as the embryo passes down the Fallopian tube. The transfer of the conceptus after fertilisation from the oviduct to the uterus is facilitated by the

changing endocrine environment of the early secretory phase with its rising ratio of progesterone to oestrogens which affects the tubal and uterine musculature.

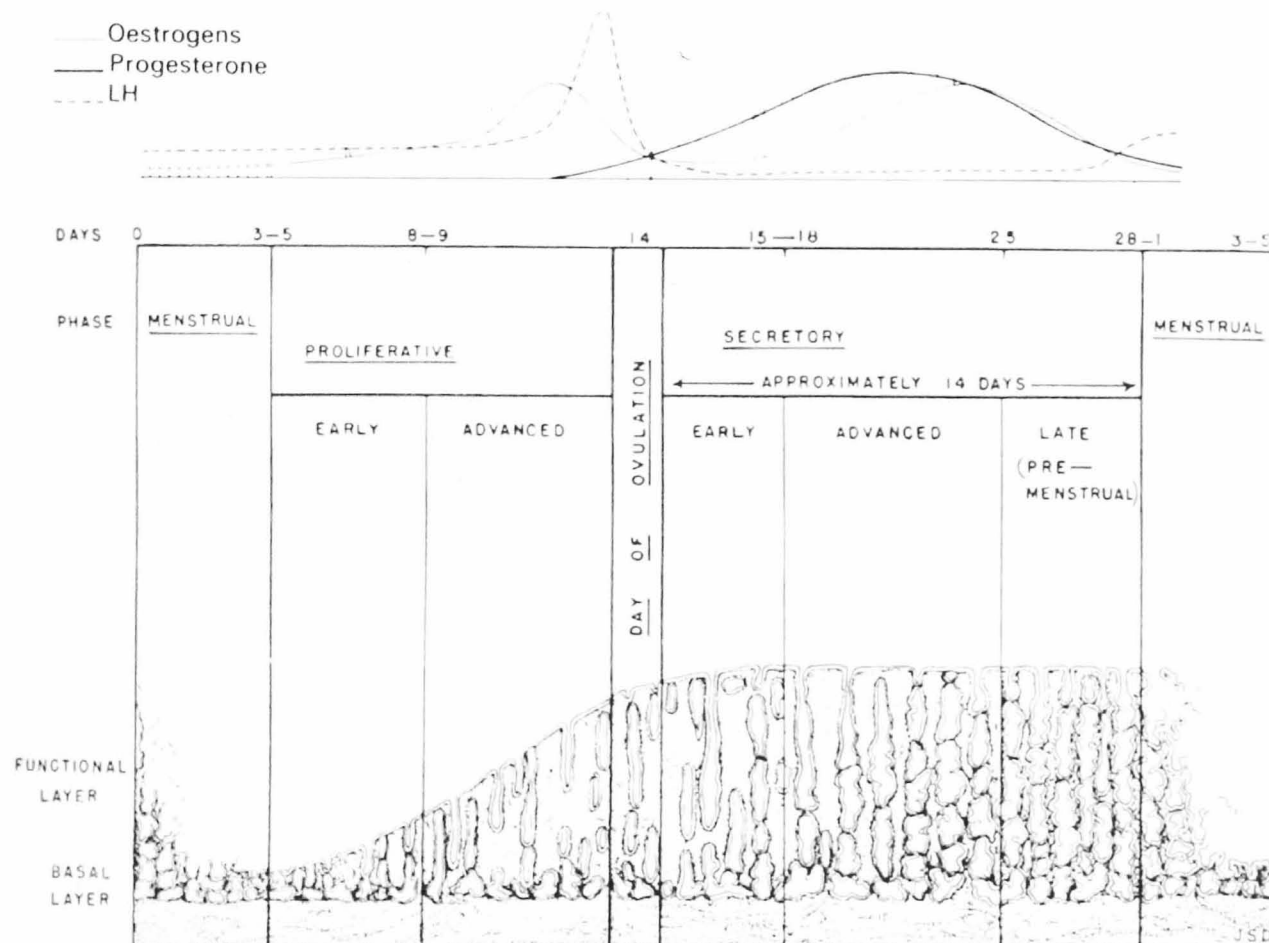

Figure 1.3 Diagrammatic representation of the menstrual cycle showing hormonal and endometrial changes. Modified from Johnson and Everitt (1988).

All the morphological and physiological changes that the human endometrium undergoes throughout the menstrual cycle are geared towards maximising the chances of fertilisation, implantation and subsequently a successful pregnancy.

1.2 Implantation

Once inside the lumen of the uterus implantation of the conceptus occurs. By this time there is transition of the morula to the blastocyst with accompanying formation of the trophoblast.

Implantation is a complex process which involves the 'invasion' of the maternal endometrium by the trophoblast surrounding the developing blastocyst. In response to this interaction there is a cellular reaction within the endometrium which has some features analagous to invasion by a tumour and some which are more characteristic of an inflammatory response. Implantation can be divided into a series of steps known as apposition, adhesion and invasion. Apposition is the positioning of the blastocyst within the uterine cavity. Adhesion follows as the cells of the trophoblast fix to maternal tissues and to each other via a group of cell adhesion molecules, including laminin and fibronectin, together with cell surface receptors for these molecules (integrins). Invasion then occurs allowing the trophoblast, through proteolytic processes, to penetrate into the maternal decidua and endometrial spiral arteries.

The blastocyst interacts with the mother in two ways. Firstly, there is the establishment of physical contact with the maternal blood system to ensure a supply of essential nutrients. Secondly, the blastocyst makes the maternal pituitary-ovarian axis aware of its presence thus preventing the normal mechanisms of luteal regression occurring with subsequent fall in progesterone levels and the loss of the pregnancy.

For the above processes to take place successfully the endometrium must be receptive. There are histologic changes of the endometrium under the influence of oestrogen and progesterone but there are other processes that are thought to be necessary for implantation and these include other hormones, growth factors and

cytokines. One of the most important cytokines involved in implantation and secreted by the endometrium is Leukaemia Inhibitory Factor (LIF) levels of which rise in the secretory phase of the menstrual cycle. A reduction of LIF at this time is associated with recurrent pregnancy loss (Stewart et al 1992). Production of human chorionic gonadotrophin (hCG) by the trophoblast maintains progesterone release from the corpus luteum until the placenta takes over this function at about 8 weeks of pregnancy and hepatocyte growth factor (HGF) enhances cytotrophoblast invasion (Norwitz et al 2001) (Table 1.1) (Figures 1.4;1.5;1.6).

Table 1.1 Some factors associated with implantation and the maintenance of early pregnancy

Hormones	oestradiol 17 β progesterone	proliferation and differentiation of epithelial and stromal cells
	hCG	maintains P4 release from corpus luteum
changes in endometrial luminal epithelium	pinopodes alterations in the expression of adhesion molecules	facilitate blastocyst capture and attachment promote trophoblast differentiation and invasion
cytokines and growth factors	LIF HGF	important for decidualisation and implantation enhances cytotrophoblast invasion
immunologic factors	IL-10 HLA-G	immunosuppression prevents immunorecognition and rejection of fetal semi-allograft

(Norwitz et al 2001).

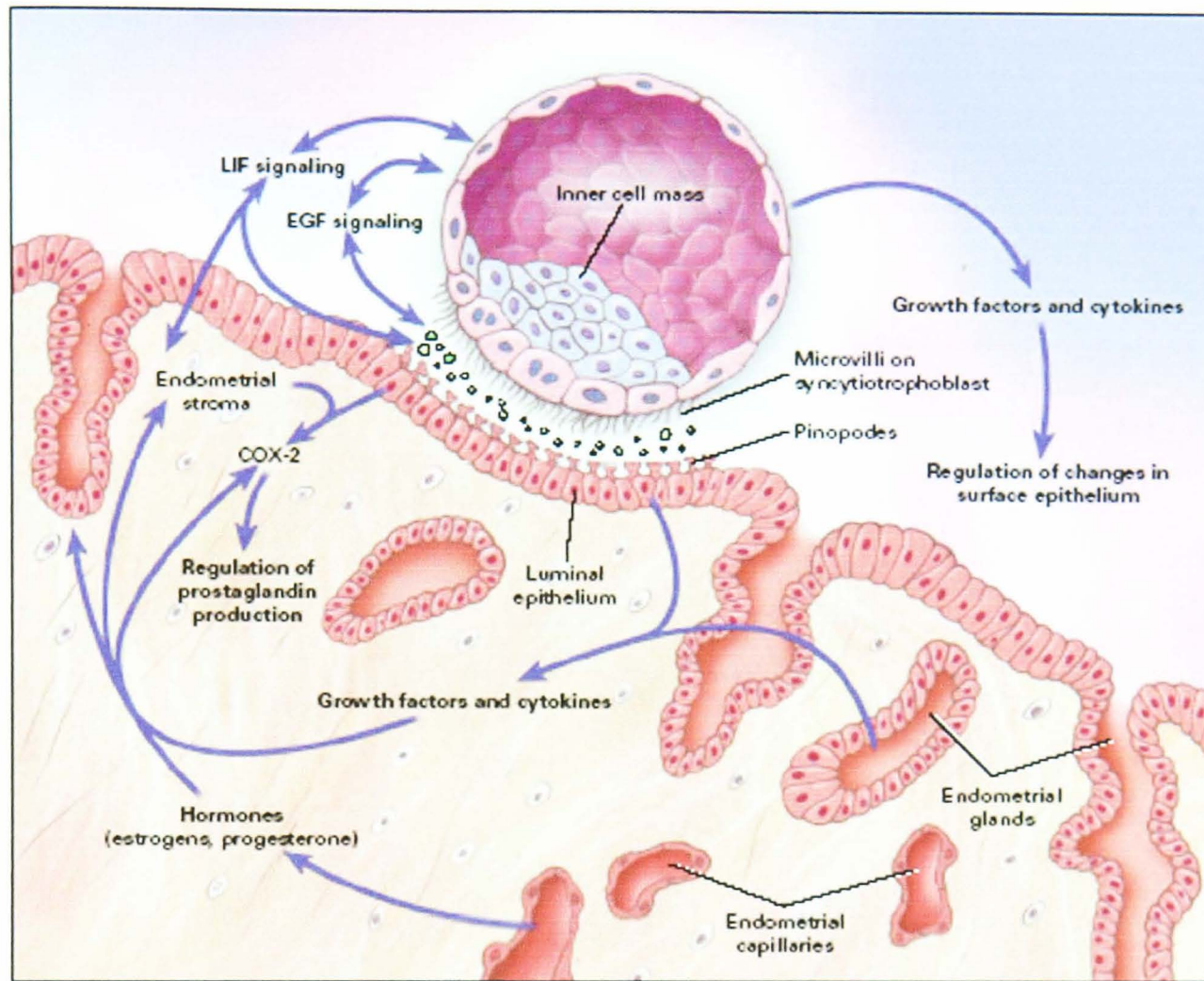

Figure 1.4 Blastocyst apposition and adhesion. The diagram represents the events that occur as the blastocyst, about 6-7 days after fertilisation, prepares to implant in the endometrium. The processes shown are those that are thought to be involved in preparing the endometrium for implantation and blastocyst apposition and adhesion. COX-2 = cyclooxygenase-2, EGF = epidermal growth factor and LIF = leukaemia inhibitory factor. From Norwitz et al (2001).

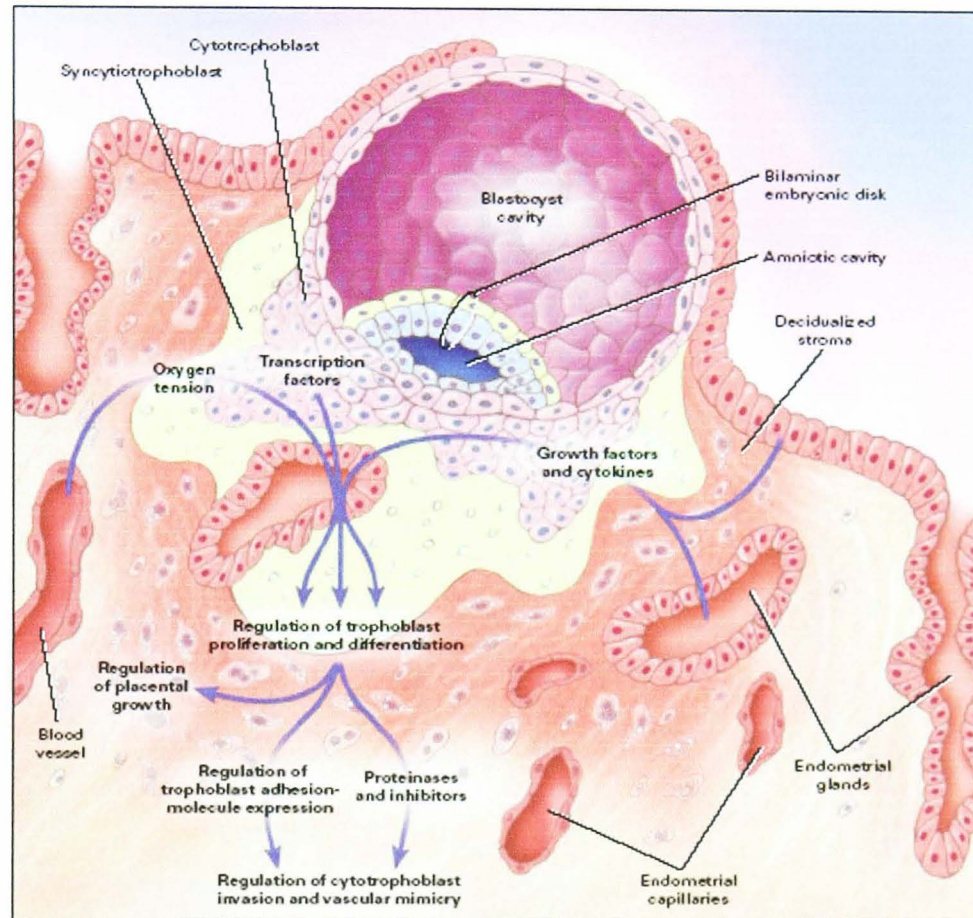

Figure 1.5 The diagram shows the blastocyst, 9-10 days after fertilisation, implanting and the processes involved in trophoblast invasion. From Norwitz et al (2001).

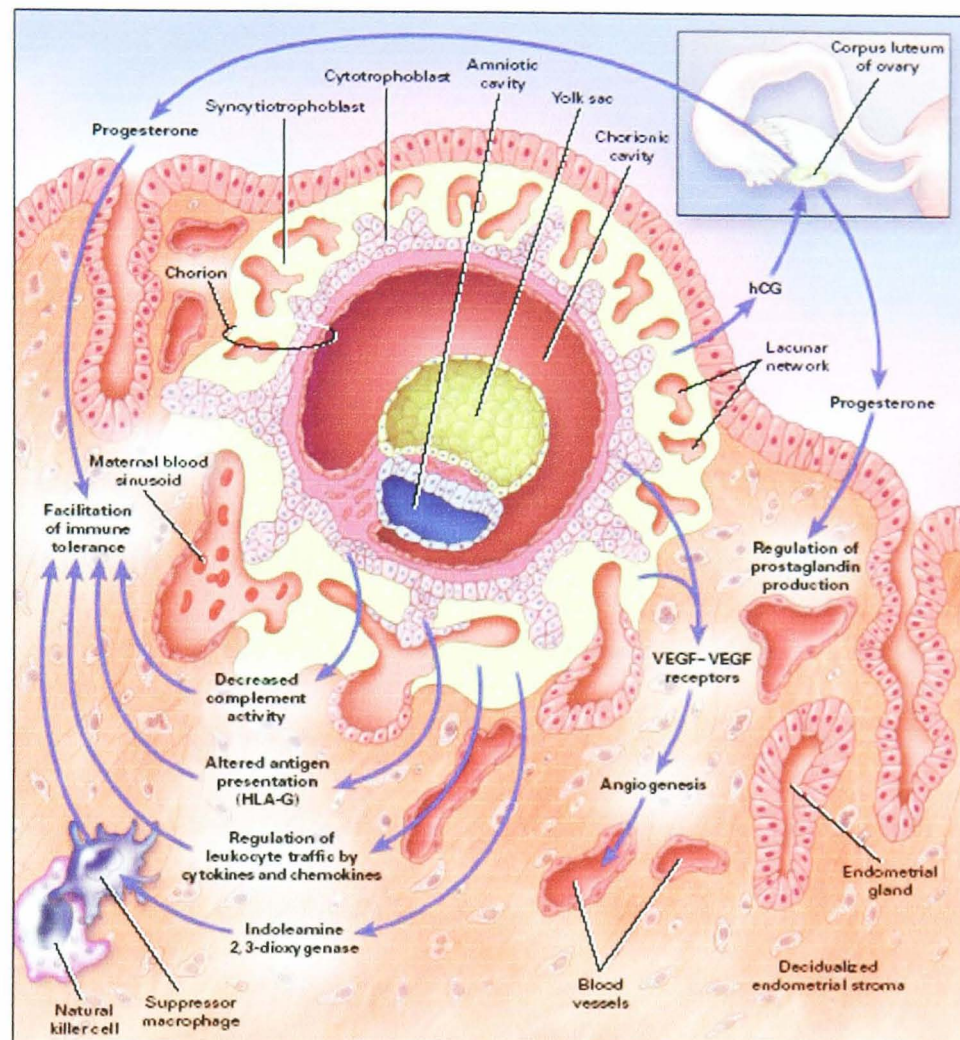

Figure 1.6. The diagram represents the implanted embryo, about 14 days post-fertilisation, and the processes involved in maintaining pregnancy. VEGF = vascular endothelial growth factor, HLA-G = human leucocyte antigen-G. From Norwitz et al (2001).

1.3 Maternal recognition of pregnancy

Central to the maintenance of pregnancy are maternal adjustments which take place to allow the retention of the embryo within the uterus. At the turn of the century it was demonstrated that the corpus luteum was essential for the maintenance of pregnancy in the rabbit and it is now considered that the mechanisms involved in the maintenance of the corpus luteum in mammalian pregnancies constitute the ‘maternal recognition of pregnancy’ – a term first described by Short (Short 1969). Progesterone is the critical hormone secreted by the corpus luteum in humans for establishing and maintaining the first 7-9 weeks of pregnancy. However, levels of progesterone secreted by the corpus luteum begins to decline around the 8-10th day post-ovulation – a critical period for nidation of the blastocyst if pregnancy is to follow. In pregnancy, the corpus luteum is maintained by hCG production by the fetal syncytiotrophoblast and consequently progesterone production continues. HCG production peaks at about 8-10 weeks of pregnancy and then declines rapidly. At this stage placental production of progesterone takes over from that of the corpus luteum. This process is called the corpus luteum-placental shift. HCG maintains the corpus luteum by mimicking the action of LH and acting on the LH receptor.

In ruminants, successful pregnancy requires the maintenance of the corpus luteum and production of progesterone. However, this process is not controlled through the action of a chorionic gonadotrophin but by interferon τ (IFN τ) which has anti-luteolytic effects through the inhibition of oestrogen receptors (Figure 1.7). Therefore, it is IFN τ which is the initial signal for the maternal recognition of pregnancy in ruminants.

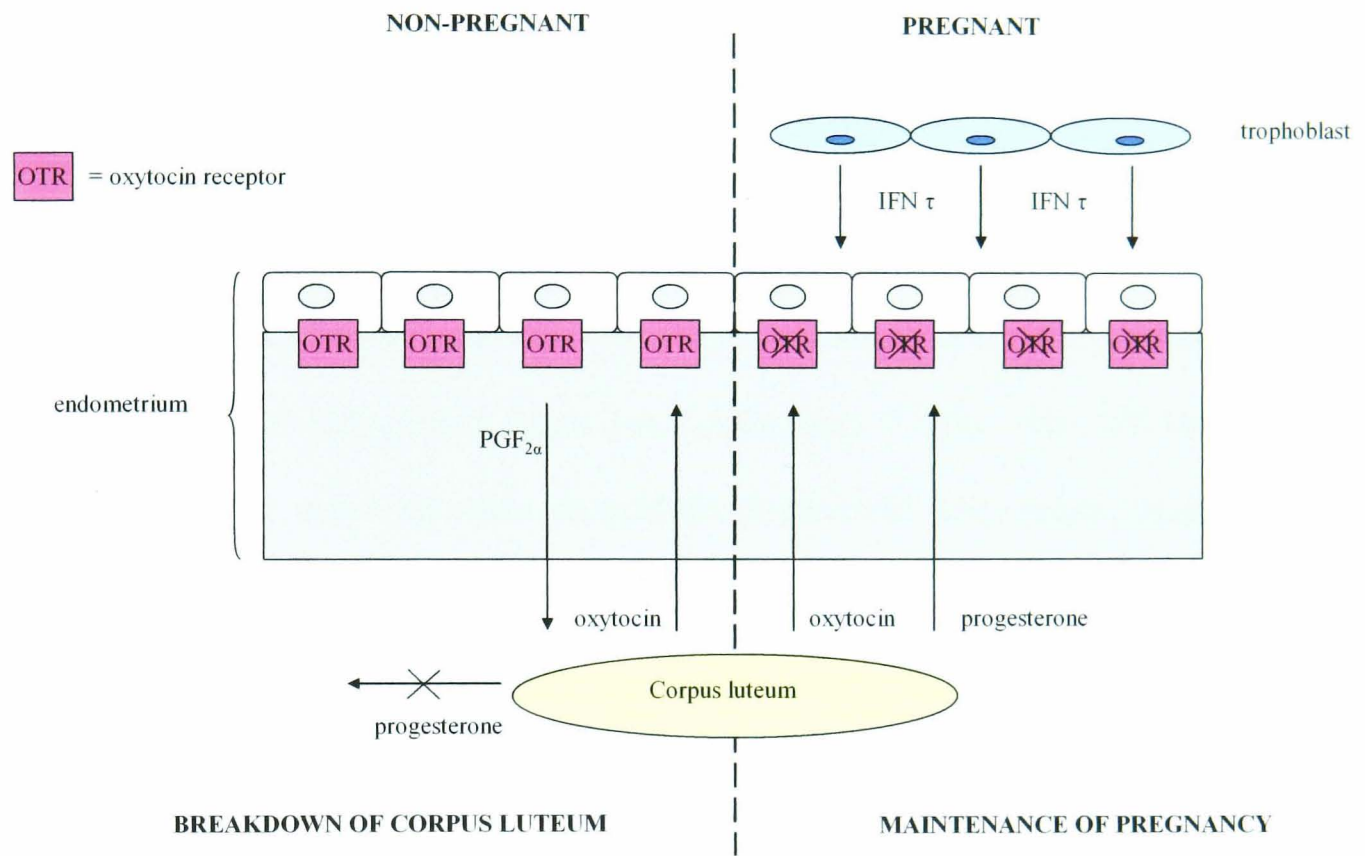

Figure 1.7 Diagram representing the role of IFN τ in the maintenance of pregnancy in ruminants. Adapted from Demmers et al (2001).

1.4 Interferons

Possibly the first described effect of interferon was in 1935 when Hoskins reported the protective action of a neurotropic yellow fever virus against a viserotropic strain of the same virus in monkeys (Hoskins 1935). Although this viral interference was investigated further the underlying mechanism and the first use of the word 'interferon' did not happen until 1957 when Isaacs and Lindemann isolated a substance from virally-infected chicken cell cultures which conferred an anti-viral effect in fresh chicken cell cultures (Isaacs and Lindemann 1957). The fact that it produced a protective anti-viral effect aroused much scientific and medical interest. By 1957 antibiotics were widely available to combat bacterial infections but viral infections, on the other hand, remained untreatable and so interferon became the substance that raised many hopes and possibilities for future treatments. However, it was difficult to characterise interferon immediately because it was only produced naturally in very low concentrations. With the advent of large scale production combined with efficient purification methods, sufficient amounts of partially pure interferon protein became available for scientific research (Cantell and Hirvonen 1977; Rubinstein et al 1978).

There are two types of interferon which are defined on the basis of their anti-viral activity to withstand acidic conditions of pH 2. Type I interferons are those which are acid-stable and Type II interferons those which are acid-labile. The Type I interferons include those produced by virally infected leukocytes and fibroblasts. In contrast, Type II interferons are only produced by stimulated human peripheral blood mononuclear cells (PBMC) - Th1 and NK cells - and are often referred to as immune interferons (Stewart 1979). As evidence grew for the existence of distinct molecular

forms of interferon, the Greek alphabetical system was applied to these separate forms. Leukocyte IFN was designated IFN α , fibroblast IFN – IFN β and immune IFN - IFN γ . Later cloning of cDNAs encoding IFN α -like proteins (Capon et al 1985) lead to the naming of an IFN as IFN α subclass II. This IFN has since been renamed IFN ω . It is antigenically distinct from IFN α and β and qualifies as a separate type of IFN (Adolf 1987).

In humans there are, at least, 18 IFN α genes and together with the single IFN β gene constitute an IFN α/β superfamily of genes. These genes are arranged on the short arm of chromosome 9 and they share the feature of being intron-less (Capon et al 1985). This suggests a very ancient origin of a common ancestral gene. It is proposed that the original Type I IFN gene arose approximately 500 million years ago with the splitting to form the IFN α and IFN β genes around 100 million years later (Wilson et al 1983). A further 300 million years later an IFN α gene derived from the main group gave rise to the IFN ω gene family which is present in most mammals, except mice and dogs (Roberts et al 1992).

The amino acid sequence of human IFN α reveals four conserved cysteine residues which form two disulphide bonds and no glycosylation sites. The bond between Cys 1 and Cys 99 is not essential whereas the bond between Cys 29 and Cys 139 is required for biological activity. The amino acids adjacent to Cys 29, Leu 30, Asp32-Arg33 are conserved in all the IFN α proteins and in IFN β . These are essential for biological activity but not for binding to the receptor (Marcucci and De Maeyer 1986). The protein sequence of human IFN β contains 3 cysteine residues, with a disulphide bond between Cys 31 and Cys 141 and a glycosylation site at position 180 on the precursor molecule.

Figure 1.8 Amino acid sequence and secondary structure of the Type I interferons IFN α (A) and IFN β (B). From the Protein Data Bank (www.rcsb.org).

 Indicates position of Cys residue and the disulphide bond

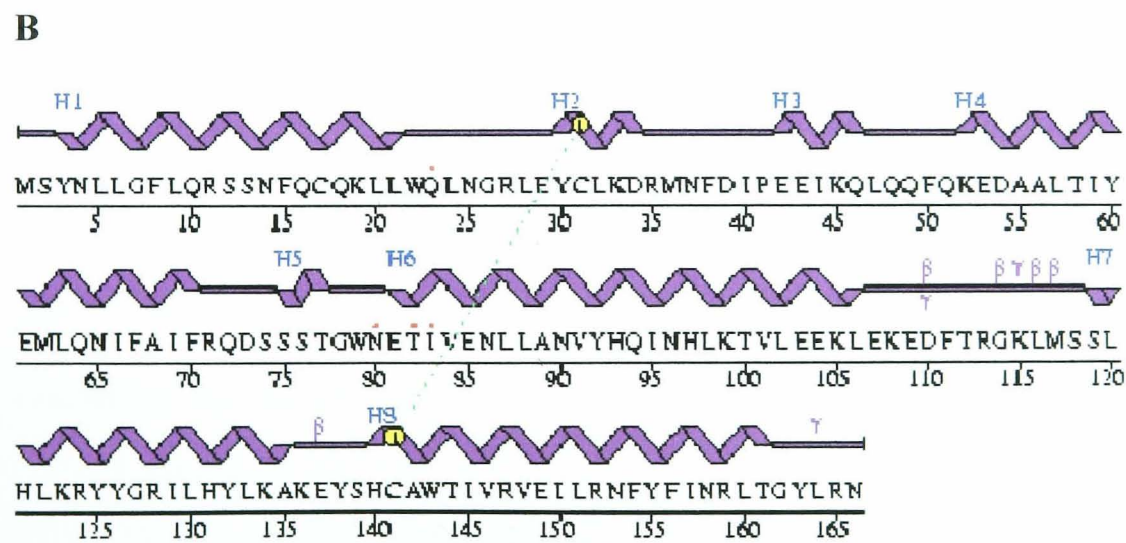
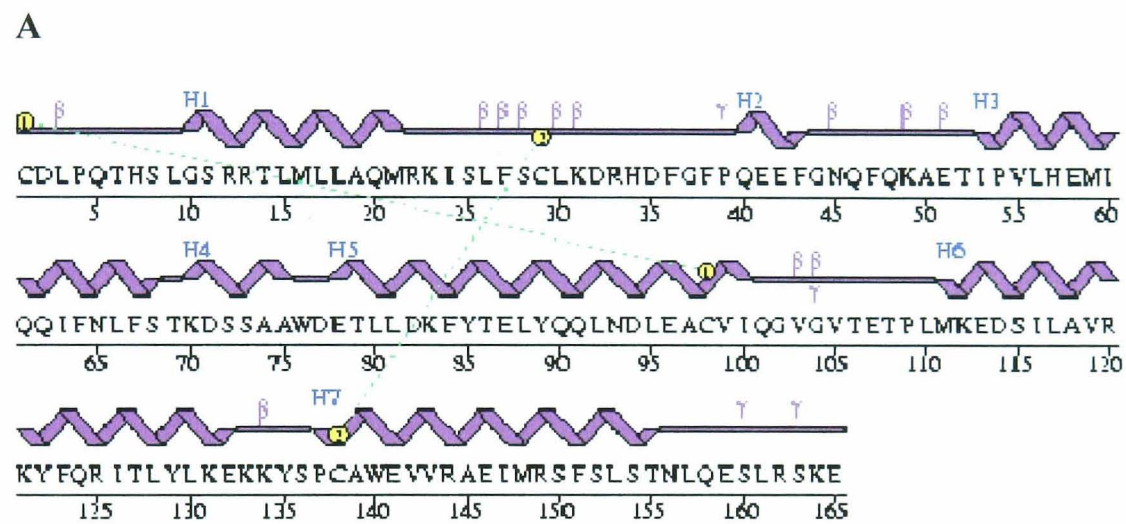

Interferon ω has two disulphide bonds at the same positions as IFN α and a glycosylation site at position 78 (Adolf et al 1991).

The mature IFN α proteins are monomers of 166 amino acids with a calculated molecular mass of 18.5 kDa. IFN β is a protein of 166 amino acids. There is 30% homology between human IFN α and IFN β proteins. The same degree of homology is found between IFN β and IFN ω , but 60% homology is found between IFN α and IFN ω . The homology between IFN α and IFN β is shown in Figure 1.8.

The paracrine secretion of IFNs results in a series of responses aimed at limiting viral spread in target cells. Type I IFNs induce an antiviral state in response to viral infection and modulates the immune response. These IFNs are negative regulators of cell proliferation and are involved in the induction of apoptosis.

Type I IFNs have a broad anti-viral activity. Cells challenged with a virus will secrete Type I IFNs which bind to other cell receptors and activate a number of IFN-stimulated genes (ISGs) in neighbouring cells. Several of the proteins encoded by ISGs, such as 2'-5' oligoadenylate synthetase (2'-5' OAS), PKR kinase and Mx (monomeric GTPase) proteins, have a direct antiviral activity.

In addition to their anti-viral activity, Type I IFNs stimulate cell-mediated immunity and interact either synergistically or antagonistically with inflammatory cytokines.

Thus IFNs α and β stimulate the expression of MHC class I antigens which are crucial for the recognition of foreign antigens. IFN α will stimulate production of a subset of T helper cells (TH1) which produce IL-2 and IFN γ and direct cell immunity.

Type I IFNs have been shown to play an important role in specific T cell memory (Tough et al 1996) and to inhibit IL-7-induced growth and survival of B cells (Su et al 1997).

Apart from their anti-viral effects, Type I IFNs have an antiproliferative effect on most cells. IFN α and β prolong all the phases of the cell life cycle without affecting the rate of DNA, RNA or protein synthesis and block growth factor-induced entry into S phase. There is mounting evidence that both IFNs α and β play a critical role in the apoptosis of virally infected cells and tumour cells although there is evidence that IFNs α and β prevent activated T cell death during infections (Marrack et al 1999). Table 1.2 shows a summary of the many biological activities of IFNs.

Table 1.2 Some biological effects of IFNs (from Chard and Iles 1992)

Inhibition of cell proliferation in culture

Suppression of stimulatory effects of growth factors

Inhibition of tumour growth in the whole organism

Inhibition of viral replication

Enhancement or inhibition of cell differentiation

Reversion of neoplastic phenotypes

Induction of specific protein synthesis (β -2-microglobulin), 2',5'A synthetase

Monomeric GTPase (Mx) proteins

Secretion of proteases and protease-inhibitors

Immunomodulatory effects

Induction of synthesis of class I HLA antigens

Suppression of cellular proto-oncogenes

Prevention of luteolysis

1.5 Interferons and early pregnancy

IFNs are generally produced in response to viral or parasitic infection and upon exposure to cytokines and growth factors. However, in the 1980s, a group of proteins were discovered which, in the absence of a viral stimulus, were secreted by the trophoblast of the preimplantation conceptuses of ruminants. One of these proteins, designated ovine trophoblast protein-1 (oTP-1) (Godkin et al 1984), was found to be released into culture medium by ovine blastocysts which were between 13-21 days old (Godkin et al 1982). This secretory protein consisted of several isoforms with molecular weights of about 18,000 Da - interestingly IFN α has a molecular weight of approximately 18,500 Da. Soon after this discovery, it was demonstrated that bovine concepti produced a similar complex of proteins (bovine trophoblast protein-1) (bTP-1) (Bartol et al 1985) which cross-reacted with oTP-1 antiserum (Helmer et al 1987) although these proteins were of a higher molecular weight ranging from 22,000 to 24,000 Da. The differences in molecular weight between oTP-1 and bTP-1 could be attributed to the presence of carbohydrate found in bTP-1 (Anthony et al 1988).

Evidence that these proteins were involved in the maintenance of pregnancy came when it was found that purified oTP-1 administered directly into the uterus of ewes delayed luteal regression (Godkin et al 1984). In non-pregnant ewes endometrial secretion of prostaglandin F $_{2\alpha}$ causes regression of the corpus luteum. In pregnancy, oTP-1 blocks endometrial prostaglandin F $_{2\alpha}$ production to prevent luteolysis and as a result the corpus luteum continues to secrete progesterone which is required for the establishment of pregnancy (Fincher et al 1986). Maintenance of the corpus luteum

at this time is one of the earliest endocrine adaptations to pregnancy and has been termed 'the maternal recognition of pregnancy' (Short 1969) (see Section 1.3).

Later, as a result of molecular cloning of cDNA and protein sequencing, oTP-1 and bTP-1 were revealed to be interferons (Stewart et al 1987; Imakawa et al 1987). Sequencing of the 40 N-terminal amino acids of the trophoblast proteins showed that the molecule shared a striking homology with the Type I IFNs; 50% homology to IFN α (Figure 1.9 and Figure 1.10) and 70% homology to IFN ω (originally IFN α II). There is also a highly conserved sequence (Cys-Ala-Trp-Glu) in all IFNs and oTP-1. The two interchain disulphide bridges are also conserved and the hydrophobicity/hydrophilicity plots of IFN α and oTP-1 are barely distinguishable (Roberts 1991). As a consequence of this discovery, oTP-1 and bTP-1 were classified as Type I IFNs and named IFN τ .

Although the main function of IFN τ appears to be that of a pregnancy recognition signal in ruminants its structural similarity to the other Type I IFNs has been borne out by its other biological activities. IFN τ can protect several cell types from lysis by viruses with at least an equal potency to that of IFN α and, like the other type I IFNs, IFN τ is capable of up-regulating 2'-5' oligoadenylate synthetase which has a direct effect on antiviral activity (Roberts et al 1992). IFN τ can slow the proliferation of bovine kidney epithelial cells and human WISH cells over the same concentrations at which IFN α is growth inhibitory (Pontzer et al 1991).

However, unlike IFN τ , the role of interferons during human pregnancy is unknown since the initial signal for maternal recognition is human chorionic gonadotrophin (hCG)(Lenton et al 1982).

Figure 1.9 Amino acid sequence alignment of IFN τ and IFN α . **c** denotes the conserved cysteines which form the disulphide bonds. Other conserved amino acids are represented in green. Modified from Radhakrishnan et al (1999).

```

IFN $\tau$   1  c y l s r k l m l d  a r e n k l l d r  m n r l s p h s c l  q d r k d f g l p q
IFN $\alpha$     c d l p q t h s l g  s r r t l m l l a q  m r r i s l f s c l  k d r h d f g f p q

IFN $\tau$   41  e m v e g d q l q k  d q a f p v l y e m  l q q s f n l f y t  e h s s a a w d t t
IFN $\alpha$     e e f d g n q f q k  a e t i p v l h e m  i q q i f n l f s t  k d s s a a w d e t

IFN $\tau$   81  l l e q l c t g l q  q q l d h l d t c r  g q g m g e e d s e  l g n m d p i v t v
IFN $\alpha$     l l d k f y t e l y  q q l n d l e a c v  i q g v g v t e t p  l m k e d s i l a v

IFN $\tau$  121  k k y f q g i y d y  l q e k g y s d c a  w e i v r v e m m r  a l t v s t t l q k
IFN $\alpha$     r k y f q r i t l y  l k e k k y s p c a  w e v v r a e i m r  s f s l s t n l q e

IFN $\tau$  161  r l t k m g g d l n  s p
IFN $\alpha$     s l r s k e

```

Figure 1.10 Amino acid sequence and secondary structure of the Type I interferons IFN α (A) and IFN τ (B). From the Protein Data Bank (www.rcsb.org).

 Indicates position of Cys residue and the disulphide bond

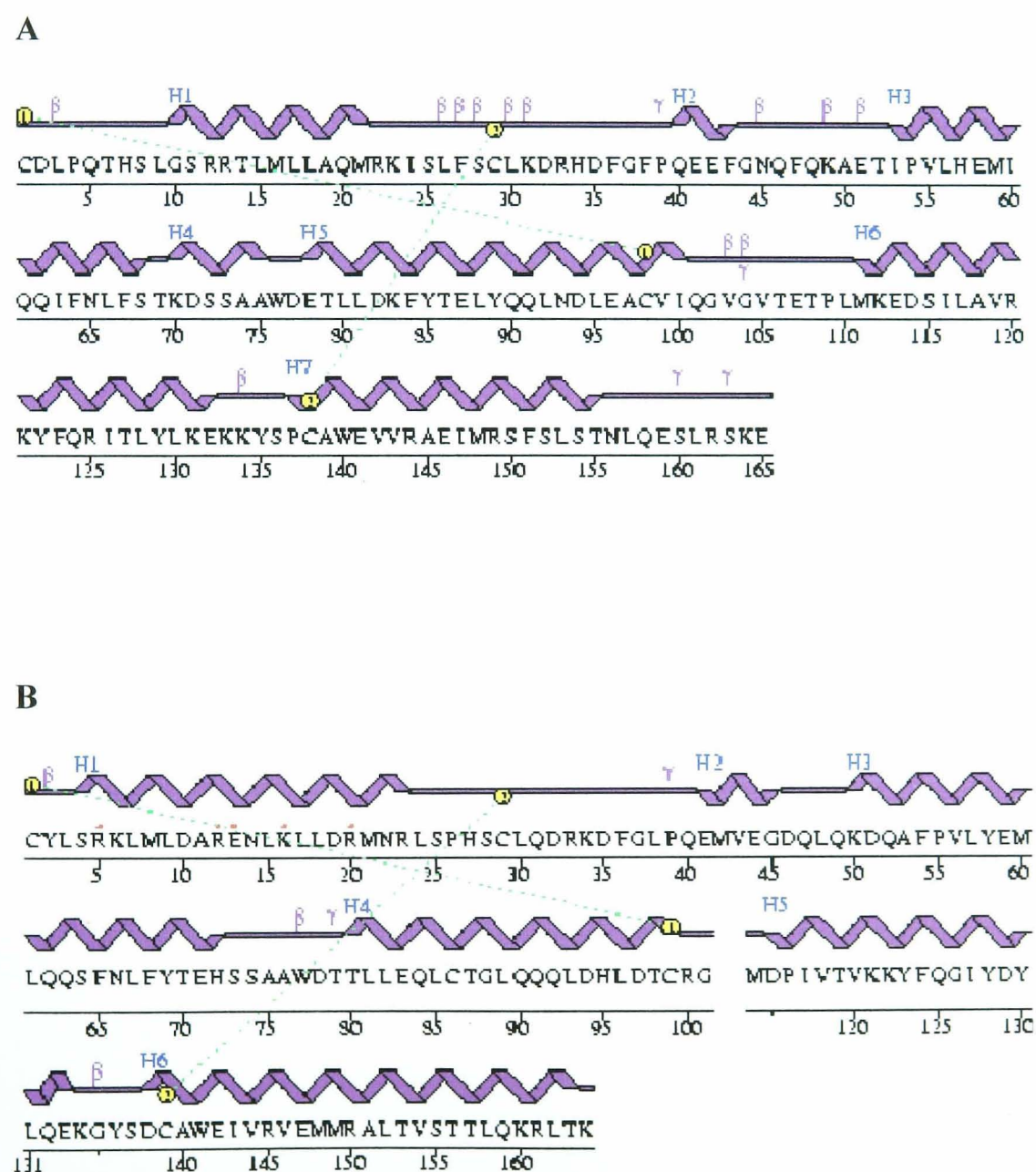

Interestingly, IFN α can stimulate hCG production in tumour cells (Iles and Chard 1989) but it is unlikely that IFN α is responsible for triggering hCG production in the early human embryo.

While IFNs have not been detected from the early human pre-embryo (Gunn et al 1994) some function in human pregnancy is possible since significant levels of IFN β and, in particular, IFN α are found in fetal tissue, placenta, membranes and amniotic fluid after implantation has been established (Chard et al 1986; Howatson et al 1988; Paulesu et al 1991). As these IFNs are found predominantly in the syncytiotrophoblast (Howatson et al 1988; Paulesu et al 1991) it is therefore possible that trophoblast IFN in the human may have a role as an immunomodulator of fetal-maternal recognition rather than in signalling implantation as it does in ruminants. (Table 1.3 and 1.4).

Table 1.3 Interferon production in human pregnancy

Reference	Findings
Ray 1970	Normal IFN response of fetal cells to virus induction
Taguchi et al 1985	IFN present in normal amniotic fluid
Duc-Goiran et al 1983 and Lorenzetti et al 1984*	Cultured amniotic fluid can release IFN (IFN β *) after viral induction
Duc-Goiran et al 1985	IFN present in fetal blood, placenta and membranes
Bocci et al 1985	IFN produced by perfused term placenta
Chard et al 1986	IFN α present in all fetal tissues, placenta membranes and amniotic fluid.
Howatson et al 1988	IFN α present in syncytiotrophoblast and macrophages of chorionic villi
Reiss et al 1989	Cultured amniotic cells release IFN β after exposure to Sendai virus
Toth et al 1991	Cultured trophoblast cells release IFN β in response to double stranded polyribonucleotide
Bulmer et al 1990	IFN α present in villous and extravillous syncytiotrophoblast and decidual leucocytes
Aboagye-Mathiesen et al 1991	Cultured trophoblast releases IFN α and IFN β after exposure to Sendai virus

Table 1.4 Interferon in animal pregnancy

Reference	Findings
Overall and Glasgow 1970	Viral infection of ewe produced low IFN response in mother but very high levels in fetus
Fowler et al 1980	IFN present at high concentrations in mouse placenta but not in maternal or other fetal tissue
Barlow et al 1984	Mouse embryo tissues produce IFN in response to viral induction
Evans et al 1985	IFN inducible in both mother and fetus
Nakane et al 1985	Maternal IFN response to <i>Listeria</i> infection in mice suppressed during pregnancy
Yamada et al 1985	IFN present in mouse placenta
Imakawa et al 1987 Stewart et al 1987, 1989	Ovine trophoblast protein (oTP-1), the major secretory protein of the early conceptus is an IFN
Imakawa et al 1989 Cross and Roberts 1991	Bovine trophoblast protein (bTP-1) is an IFN
Farin et al 1989	mRNA for oTP-1 localised to trophoctoderm
Cross and Roberts 1989 LaBonnardiere et al 1991	Porcine pre-attachment conceptuses secrete IFN
Roberts et al 1992	oTP-1 and bTP-1 are named IFN τ
Spencer et al 1995	IFN τ alters oestrogen and oxytocin receptors in the endometrium of ewes

1.6 The mechanism of action of interferon

To determine a role for IFN in human fetal-maternal recognition it is necessary to understand the nature of the interaction of interferon-receptor binding culminating in the generation of a response.

In the sheep, the mechanism of action of IFN τ has been studied in some detail and it is known to maintain pregnancy through its anti-luteolytic effects (Godkin et al 1984). This is achieved through maintained progesterone secretion by the inhibition of oestrogen receptors which, in turn, leads to an inhibition of oestrogen-induced up-regulation of oxytocin receptors (see Figure 1.7).

Together with an activation of cyclooxygenase inhibitors, there is a shift in the prostaglandin PGE₂:PGF_{2 α} ratio to favour PGE₂ over PGF_{2 α} with a subsequent continued secretion of progesterone (Spencer et al 1995; Mann et al 1999 and Hansen et al 1999). Interestingly, it has been shown that PGE₂ has a variety of immunosuppressive activities (Goodwin and Ceuppens 1983) which include the down-regulating of IL-2 production by decidual Natural Killer (NK) cells and an increase in pregnancy loss associated with elevated NK cell activity after treatment with a prostaglandin inhibitor.

Both natural and recombinant IFN τ have been shown to suppress oxytocin-induced secretion of prostaglandins in bovine endometrial epithelial cells (Danet-Desnoyers et al 1994).

It is particularly significant that human IFN α not only competes with IFN τ for the same ovine endometrial receptor (Stewart et al 1987; Russell et al 1993) but has the same effect as IFN τ on the ovine endometrium as it inhibits prostaglandin synthesis (Mitchell and Smith 1992). In contrast, human IFN α does not result in inhibition of prostaglandin synthesis in the human endometrium, although it does attenuate the inhibitory effect of progesterone on PGF $_{2\alpha}$ release (Mitchell and Smith 1992). Moreover, porcine trophoblast protein (pTP-1) actually stimulates prostaglandin synthesis in the porcine endometrium (Mitchell and Smith 1990). This suggests that the signalling mechanism for the same IFN must be different for individual species thus accounting for the difference in response.

The signal transduction mechanisms that generate a response following Type I IFN-receptor binding are only recently becoming clear. It is now accepted that IFNs ultimately exert their effects through the induction of gene transcription. Understanding of IFN signalling began with studies of IFN-inducible genes. Both Type I and Type II IFNs induce the transcription of an overlapping set of genes (Sen and Lengyel 1992; Pellegrini and Schindler 1993). Two DNA elements present in the promoters of inducible genes were defined by progressive deletion/mutation of reporter constructs and studies of IFN-dependent DNA-protein interactions. These two elements, called IFN-stimulated response element ISRE and γ activation site GAS, are able to control gene expression in the absence of protein synthesis. It was originally thought these elements were mediated by IFN α/β (ISRE) or IFN γ (GAS), it is now known that there is an overlap between both elements in that they respond to different extents to either type of IFN (Muller et al 1994).

Binding of the Type I IFNs to their receptor results in the activation of the multimeric transcription factor, interferon-stimulated gene factor 3 (ISGF3). This is achieved through phosphorylation of latent cytoplasmic proteins known as signal transducer and activator of transcription (STAT) proteins (see section 8.1). Together these constitute ISGF3 α . Binding of ISGF3 α to another protein, ISGF3 γ , forms ISGF3. This complex migrates to the nucleus where it binds to the ISRE. The way in which the signal is transduced from the Type I IFN-receptor binding event to phosphorylation of the ISGF3 α remained unclear for some time. Initially, protein kinase C (PKC) was implicated in mediating the effects of IFN α on gene expression in HeLa cells (Pfeffer et al 1990) and ovarian carcinoma cells (Powell et al 1993). However, this assumption was based on studies conducted with inhibitors which are not specific for PKC. In contrast, other workers have shown that the induction of transcription by IFN α in HeLa cells is apparently mediated through a protein kinase distinct from PKC (Kessler and Levy 1991; Schindler et al 1992; David et al 1993). Although the IFN α/β receptor does not have intrinsic protein kinase activity (see section 5.1) it has been demonstrated that the receptor is associated with tyrosine kinases of the Janus kinase (JAK) family which are required for the correct assembly of the receptor (see section 5.1) (Muller et al 1993; Darnell et al 1994). Binding of IFN α/β to its receptor results in phosphorylation and activation of the JAKs which then phosphorylate the STAT proteins leading to ISGF3 activation (Muller et al 1993; Darnell et al 1994).

Although the IFN α/β receptor response has been well characterised, it is not fully understood how the JAKs are activated. Furthermore, this model does not solve the

dilemma of how activation of the same receptor can lead to different responses in different cell types, or the diversity of responses induced by different isoforms of the same IFN subtype. It is possible that the specificity of the response may depend upon the activation of different subsets of STAT proteins or isozymes of the JAK family proteins. Alternatively, it may be regulated by the modification of similar proteins (Dr Ian Kerr, personal communication). In this regard, other signalling pathways activated by IFNs may possibly crosstalk with the JAK/STAT pathway to modify the response.

Activation of membrane phospholipid hydrolysis is frequently used to generate second messengers as a mode of signal transduction. Activation of different membrane phospholipases following ligand receptor binding yields different second messengers which are each responsible for a variety of effects (see Figure 7.3). Pathways which generate second messengers have indeed been shown to be associated with Type I IFN responses and differ according to cell type. IFN α treatment of mouse fibroblasts transiently stimulates phospholipase A2 accompanied by a rapid release of arachidonic acid (Hannigan and Williams 1991) whereas interaction of IFN α with the human fibroblast or Daudi cell stimulates a rapid release of diacylglycerol and inositol phosphates (Yap et al 1986), presumably due to activation of a phosphoinositide-specific phospholipase C (Popescu et al 1989). On the other hand, preferential hydrolysis of phosphatidylcholine (PC) via phospholipase C has been demonstrated when HeLa cells are stimulated with IFN α (Pfeffer et al 1990). In this study simultaneous activation of phospholipase D could not be ruled out.

Since there is a rapid but transient increase in diacylglycerol after exposure of several cell types to IFN α (Yap et al 1986; Cataldi et al 1993) it has been suggested that activation of PLC is the initial event in the IFN α induced transmembrane signalling pathway in these cells.

Diacylglycerol is responsible for activating protein kinase C (PKC) (Nishizua 1988). Preliminary studies assaying histone III phosphorylation demonstrated that recombinant ovine IFN τ activates PKC in Madin-Darby Bovine Kidney (MDBK) cells, suggesting a role for PKC in mediating the IFN τ induced inhibition of expression of the oxytocin receptor (Commander et al 1993). However, the initial signal transduction mechanism for generating the second messenger diacylglycerol, which activates PKC in this system, is not fully understood. It is possible that activation of PKC in the sheep endometrium may even be triggered through alternative pathways. Interestingly, phospholipase C can be activated by epidermal growth factor receptor tyrosine kinase (Berridge 1993), by-passing G-protein associated receptor binding. Thus it is possible that the JAK family proteins may serve a dual function, that of STAT protein phosphorylation as well as phospholipase C activation resulting in PKC activation to achieve a full response.

Since there are clear inconsistencies in the signalling mechanisms used by Type I IFNs depending on cell lineage and species, it is likely that the signalling mechanisms may be different in the human and the sheep endometrium. To date we are unaware of any studies which have specifically addressed the question of how Type I IFN interaction with the human endometrium receptor transduces its signal.

In summary, ruminant Type I interferon, IFN τ , signals maternal recognition of pregnancy through inhibition of oxytocin receptor expression resulting in prostaglandin (PG) synthesis inhibition. Human Type I interferons, IFNs α and β , are produced post-implantation but their role is unknown. Like IFN τ , human IFN α inhibits PG synthesis in ovine endometrium. However, it is not inhibitory in human endometrium. This suggests that the signalling mechanism for the same IFN differs for individual species. Type I IFNs bind to a common receptor resulting in activation of tyrosine kinases (JAKs) which activate latent cytoplasmic signal transducer and activator of transcription (STAT) proteins. The dilemma remains of how activation of the same receptor by various IFN subtypes leads to a diversity of responses in different cells. The specificity of the response may depend upon activation of JAK isozymes or different STAT subtypes. Alternatively, other signalling pathways activated by IFNs may crosstalk with the JAK/STAT pathway to modify the response. Activation of membrane phospholipid hydrolysis is frequently used as a mode of signal transduction and has been associated with Type I IFN responses differing according to cell type.

1.7 Cell signalling

The hallmark of multicellular life is specialisation. Nearly all cells of a higher organism will have the same organelles, same metabolic pathways, the same genes and most of the same chemical constituents. However, each cell is unique in that it will express certain components to a greater degree to provide a specific function which is of use to that organism, for example, to secrete a specific product or to regulate homeostasis. If these specialised cells are to serve the organism there must be communication between them.

Historically, one of the early breakthroughs in the understanding of cell-to-cell communication came at the end of the nineteenth century. In 1894, Schafer discovered that extracts of adrenal medulla had a striking effect on muscular tissue and this led him to propose the concept of chemical messengers secreted into the blood from ductless glands. After Schafer's discovery the study of chemical signalling was largely confined to that of the neurotransmitters and hormones of the endocrine glands, such as the pituitary, thyroid, testes and ovary (Rasmussen 1991). It also became apparent that other tissues not known to be endocrine glands, for example the heart, liver, kidney and gastrointestinal tract, also secreted specific hormones and that molecules other than hormones, such as growth factors and cytokines, were also involved in cell communication. Initially it was thought that hormones exerted their effects either by acting as co-factors for enzymes or by internally releasing trace substances. A major advance in the understanding of how these molecules work was due to Sutherland and colleagues, in 1959, who discovered cyclic adenosine 3',5'-mono-phosphate (cAMP). They found that epinephrine did

not get into the liver cell and interact with an enzyme but, instead, interacted with a receptor on the cell surface. This interaction activates the enzyme adenylate cyclase which breaks down adenosine triphosphate (ATP) to cAMP and pyrophosphate. The cAMP generated then diffuses into the liver and activates the enzymes involved in catalysing the breakdown of glycogen to produce glucose. Sutherland then found that the cAMP messenger system was more or less universal to all mammalian cells and not only did the system activate the liver cells to release glucose but it activated adrenal cortical cells to secrete cortisol and thyroid cells to release thyroid hormone (Sutherland 1972). From these findings the concept was formed that using the same intracellular signalling pathway a variety of cells could be activated to perform their specific functions. Further studies by Krebs showed that cAMP activated an enzyme called a protein kinase (Walsh et al 1968). Protein kinase catalyses the reaction between ATP and a protein to form ADP and a phosphorylated protein. Phosphorylation alters the covalent structure of the protein molecule and in doing so alters its function. Many different protein kinases have since been discovered. Both cAMP and Ca^{2+} dependent protein kinases transfer the terminal phosphate on ATP to a serine or threonine residue on the protein. However, there is a group of kinases where the phosphate is transferred to the tyrosine residue and these kinases are closely associated with growth factor receptors.

The question arises is how does a change in cAMP act as an intracellular signal messenger in so many different types of cells expressing very different responses. How is the specificity of the response achieved? Firstly, the distribution of the cell surface receptors for specific signals are usually restricted to specific target cells. Thus, continuing to use examples already referred to, the receptor for epinephrine is found on the surface of liver cells but not on adrenal cortical cells. So no matter how

high the epinephrine concentration is in the blood there will be no recognition of this fact by adrenal cells, no rise in cAMP and no increase in cortisol secretion. Secondly, the specificity will be related to the functional capacity of the cell. The receptor for epinephrine is linked to the activation of adenylate cyclase in whatever tissue it is found. Receptor activation in the liver leads to glycogen breakdown and glucose release whereas in the heart there is an increase in heart rate and contractility. The difference in response of these two tissues to the same messenger is due to the difference in the substrates for cAMP dependent protein kinase. The heart does not possess the enzyme glucose-6-phosphatase and therefore glycogen breakdown does not occur and conversely the liver cells do not possess the contractile system of the heart so no matter how high the cAMP rises no contraction will occur.

However, only a few intracellular signalling systems operate to couple an extracellular messenger to an intracellular response, most extracellular messengers activate various intracellular signalling pathways.

Since Sutherland's discovery of the interaction of cAMP with a cell surface receptor many other signalling mechanisms have been elucidated. The different signalling mechanisms are as a result of the differences in cell surface receptors. A common feature of cell surface receptors is that their activation leads to an increase in phosphorylation of cytoplasmic proteins on tyrosine residues. This kinase activity can either reside in the receptor, for example, protein tyrosine kinase receptors or in an associated protein, for example, the cytokine class I and II receptors. There are receptors for the transforming growth factor – β superfamily which also signal via the activation of protein phosphorylation but with specificity for different residues, serine

and threonine. There are receptors for the tumour necrosis superfamily and receptors with seven transmembrane domains that couple to G proteins.

1.7.1 Signalling through receptor tyrosine kinases

The hallmark feature which distinguishes the receptor tyrosine kinase (RTK) family from other receptor classes is the presence of a tyrosine kinase domain in the intracellular portion. Signalling through the RTK family is activated by the binding of growth factors which leads to the activation of several different pathways. The best described pathways are:

- a) the phospholipase C γ (PLC γ) pathway which was the first RTK signalling pathway to be identified. PLC γ hydrolyses PIP₂ into DAG, an activator of protein kinase C, and IP₃ which mobilises Ca²⁺ from intracellular stores
- b) PI3 kinase signalling where PI3 kinase catalyses the addition of phosphate to the 3'-position of phosphatidylinositol (PI) and other polyphosphoinositols. PI3K was the first signalling molecule to be shown to physically associate with the RTKs
- c) Ras signalling which is activated by the guanine nucleotide exchange factor (GNEF) known as the Son-Of-Sevenless (Sos) which binds to growth factor receptor-bound protein 2 (Grb2). Grb2, in turn, associates with RTK and leads to the activation of the Mitogen Activated Protein (MAP) kinase cascade.

1.7.2 Signalling through cytokine Class I and II receptors

The cytokine class I and II receptors lack their own tyrosine kinase activity but associate with cytoplasmic protein tyrosine kinases.

Cytokines binding to the class I and II receptors activate the JAK–STAT signal transduction pathway. This pathway consists of the JAKs, Janus kinases, which are a family of membrane-associated cytoplasmic protein tyrosine kinases and the STATs, Signal Transducers and Activators of Transcription, which are a family of SH2-domain containing proteins. The STATs are activated by the tyrosine phosphorylation within the receptor complex. The tyrosine phosphorylated STAT proteins either alone or in association with other proteins migrate to the nucleus where they bind to specific response elements in the promoters of inducible genes. This signalling pathway is a very direct route to transcriptional activation.

1.7.3 Signalling through G-protein coupled receptors

G-protein coupled receptors (GPCR) and their endogenous agonists are important in regulating the physiology of every major organ and system. The ligands for the GPCRs range from small amines and peptides to large glycoproteins. These ligands transduce signals through various mechanisms including stimulation or inhibition of adenylyl cyclase or through the activation of calcium release via the inositol-1,4,5-triphosphate pathway.

For all of these receptors the binding of the agonist is inhibited by GTP but this inhibition is reversed by the presence of guanine nucleotide binding protein (G protein).

The GPCRs are proteins with seven hydrophobic transmembrane helices. All the receptors so far cloned are structurally and functionally related and all display the seven transmembrane motif.

The G-proteins are heterotrimeric proteins consisting of α , β and γ subunits but it is the α subunit which plays the major role in the activation of the GPCR. The receptor is activated by ligand binding. There is an increase in the rate of dissociation of GDP which activates the G-protein. Then another guanine nucleotide, usually GTP, binds and causes the G-protein subunits to dissociate from each other and the receptor thus completing the activation process. The activated G-protein subunits bind to and modulate the activity of various enzymes, ion channels and receptors.

1.8 Aims of the thesis

The aim of this project is to test the hypothesis that while Type I IFNs (IFN α , β and τ) activate a common tyrosine kinase signalling pathway in the human endometrium, it is the simultaneous activation of different phospholipase pathways which confers the specificity of the IFN response.

The specific aims of this thesis are:

- 1) to culture long-term, primary human endometrial cells which have retained certain phenotypic features which are characteristic of the stage of the menstrual cycle at which the tissue was taken
- 2) to determine whether primary human endometrial cells possess a functioning Type I IFN receptor and will respond to Type I IFNs
- 3) to establish that phospholipid turnover occurs in primary human endometrial cells in response to Type I IFNs and to identify the species of phospholipid involved
- 4) to establish the presence of JAK/ STAT proteins in primary human endometrial cells in culture
- 5) to determine if there is phosphorylation of the JAK/STAT proteins in response to Type I IFNs α , β and τ .

The elucidation of the signal transduction mechanisms of IFNs on the human endometrium may support the theory that the JAK/STAT pathway is a universal signalling mechanism used by Type I IFNs.

Furthermore, we explored the possibility that the Type I IFNs trigger other pathways and, in doing so, show for the first time that there is crosstalk between different signalling pathways which confers specificity of the IFN response.

CHAPTER 2

GENERAL MATERIALS AND METHODS

2.1 Major equipment

MDH CLASS II LAMINAR FLOW CABINET	Gift from Dr A Creighton, St Bartholomew's Hospital, London, UK
GALLENKAMP INCUBATOR	Gift from Dr A Creighton, St Bartholomew's Hospital, London, UK
CENTRIFUGES: a) MSE Coolspin b) Mistral 2000 c) Haraeus Fresco Biofuge	MSE, Crawley, East Sussex, UK PLS Ltd, Forest Row, East Sussex, UK
FLOWGEN E455 POWER SUPPLY UNIT	PLS Ltd, Forest Row, East Sussex, UK
GAMMA COUNTERS: a) NE 1600 multihead b) Hydragamma 16 c) Wilj single well	Nuclear Enterprises, Edinburgh, Scotland Innotron Ltd, Oxford, Oxon Wilj Electronics, Ashford, Kent

<p>BETA COUNTER:</p> <p>Packard Minaxi 4000</p>	<p>Packard, Berkshire, UK</p>
<p>SALTER ELECTRONIC BALANCE</p>	<p>Phillip-Harris Scientific, Park Royal, London</p>
<p>pH METER</p>	<p>Sigma Chemical Company, Poole, Dorset</p>
<p>COMPUTER SOFTWARE:</p> <p>a) Multicalc data reduction software</p> <p>b) Astute statistical software</p>	<p>EG and G Wallac, Milton Keynes, Bucks</p> <p>DSS software, Leeds, Yorkshire</p>
<p>MICROSCOPES:</p> <p>a) Leica Hoffmann phase contrast</p> <p>b) Olympus CK</p>	<p>Leica Microsystems (UK) Ltd, Milton Keynes, Bucks</p> <p>Olympus Optical Company, Southall, Middlesex</p>
<p>ELECTROPHORESIS TANK</p>	<p>BioRad Life Science, Hemel Hempstead, Herts</p>

2.2 Minor equipment

VORTEX MIXER	Hook and Tucker, Croydon, Surrey
MAGNETIC STIRRER	Jencons Scientific Equipment, Hemel Hempstead, Herts
GASES: a) 95% air and 5% carbon dioxide b) oxygen-free nitrogen	BOC Limited, Guildford, Surrey
STERILE PLASTICS: a) Tissue culture flasks b) 0.4 μm pore size well inserts c) centrifuge tubes d) Nunc 8 chamber slides e) graduated pipettes	Falcon, Becton Dickinson, Plymouth, Devon Invitrogen, Paisley, Scotland Western Lab Services, Aldershot, Wilts
X-RAY FILM: Kodak X-Omat XAR5	Sigma Chemical Company, Poole, UK
PIPETTES: a) Finnpipettes b) Multistep repeating pipette	Jencons Scientific Equipment, Hemel Hempstead, Herts Eppendorf, Hamburg, Germany

BLOTTING MEMBRANE: Immobilon (PVDF)	Millipore (UK) Limited, Watford, Herts
FILTERS: a) 0.22µm filters b) Whatman filter paper	Millipore (UK) Limited, Watford, Herts BDH, Lutterworth
GLASSWARE	Jencons PLC, Leighton Buzzard, Beds
SIGMACOAT	Sigma Chemical Company, Poole, Dorset
TLC PLATES: a) Whatman LHP-K plates b) Silica gel 60 plates	BDH, Lutterworth
STATIONERY	Niceday, Erith, Kent

2.3 Reagents

General laboratory chemicals (Analar or Molecular Biology grade) were supplied by:
Sigma Chemical Company, Poole, UK or BDH Chemicals Limited, Lutterworth, UK.

2.3.1 Primary Cell Culture

<p>Dulbecco's modified Eagle's (DMEM) and Ham's F12 medium</p> <p>DMEM:Ham's F12 phosphate-free medium</p> <p>L-glutamine</p> <p>β estradiol</p> <p>Type II-s collagenase</p> <p>0.4% Trypan blue solution</p> <p>Poly-l-lysine</p> <p>Phosphate buffered saline tablets pH7.4 (0.01M phosphate buffer, 0.0027M potassium chloride, 0.137M sodium chloride)</p>	<p>Sigma Chemical Company, Poole, Dorset, UK</p>
<p>Fetal calf serum</p> <p>Antibiotic/antimycotic solution x100 (penicillin G 10 000units/ml; streptomycin sulphate 10mg/ml; amphotericin B 25μg/ml)</p> <p>Trypsin:EDTA solution x10 (0.5% trypsin:530 mmol EDTA)</p>	<p>Invitrogen, Paisley, Scotland, UK</p>
<p>Anti-vimentin (mouse anti-human clone V90)</p> <p>Anti-cytokeratin (mouse anti-human clone MNF116)</p> <p>Alkaline phosphatase mouse IgG Fast Red</p>	<p>Dako Limited, High Wycombe, UK</p>

Where possible all materials for cell culture were purchased sterile. In other cases, solutions, for example, PBS, and implements, such as forceps and scissors, were

autoclaved. If autoclaving could not be carried out then solutions were passed through a 0.22 µm filter and implements were immersed in 70% ethanol for at least 24 hours and then air dried in the sterile laminar flow cabinet. 95% air and 5% carbon dioxide gas was passed through a sterile plugged glass pipette prior to filling the flasks.

2.3.2 Immunoassays

PP14 antigen	Dr H Bohn, Behringwerke AG, West Germany
Sheep polyclonal anti-PP14 (172-173 4/4 1995)	Gift from Dr B Teisner, Odense University Hospital, Denmark
IGFBP-1 antigen Sheep polyclonal anti-IGFBP-1 (s515, 4 th bleed)	Gift from Professor T Chard, Department of Reproductive Physiology, St Bartholomew's Hospital, London, UK
Chloramine T Sodium metabisulphite Polyethylene glycol 6000	BDH Chemicals Limited, Poole, Dorset
Heat inactivated horse serum	Invitrogen, Paisley, Scotland
Bovine serum albumin	Sigma Chemical Company, Poole, Dorset
Carrier-free sodium ¹²⁵ I (IMS-30)	Amersham International, Amersham, UK
Sephadex G-100	Pharmacia, Uppsala, Sweden
Enzyme immunoassay kits for LIF, IFN γ , TNF α , IL6 and HGF	Gift from Dr E Bosmans, Eurogenetics, Tessenderlo, Belgium

2.3.3 Immunocytochemistry and immunohistochemistry

Giemsa stain	Sigma Chemical Company, Poole, Dorset
Human interferon α	Peptotech EC Limited, London, UK
Polyclonal anti-human IFN α receptor	Santa Cruz Biotechnology Inc., California, USA
Monoclonal anti-human IFN α/β receptor	Transduction Laboratories, Kentucky, USA
Elite ABC kit	Vector Laboratories, California, USA
^{125}I anti-digoxin	Gift from Department of Chemical Pathology, St Bartholomew's Hospital, London, UK
Biocell's EM grade immunogold conjugate (goat anti-mouse IgG and IgM)	Agar Scientific, Stansted, UK

2.3.4 Thin Layer Chromatography

All phospholipids	Sigma Chemical Company, Poole, Dorset
Glycerol standards – monolein, diolein and triolein	
Potassium oxalate	BDH Chemicals Limited, Poole, Dorset
^{33}P orthophosphate	Amersham International, Amersham, UK
^3H glycerol	
Ecoscint scintillation fluid	National Diagnostics, Atlanta, Georgia, USA
Scintillation vials	
Interferon β	Peptotech EC Limited, London, UK
Interferon τ	Gift from Department of Reproductive Physiology, St Bartholomew's Hospital, London, UK

2.3.5 SDS-PAGE and Western blotting

Control cell lines U3C and U4C	Gift from Dr Ian Kerr, Cancer Research UK, Lincoln's Inn Field, London, UK
Anti-STAT 1 α p91 (c-111) Anti-STAT 2 (c-20) Anti-JAK 1 (Q-19) Anti-Tyk 2 (c-20)	Santa Cruz Biotechnology Inc., California, USA
Anti-phosphotyrosine PY20	ICN Pharmaceuticals Limited, Basingstoke, UK
Anti-phosphotyrosine 4G10	TCS Biologicals, Botolph Claydon, UK
Protein A sepharose CL-4B	Pharmacia, Uppsala, Sweden
Enhanced chemiluminescence (ECL) Western blotting system Rainbow markers Peroxidase conjugated second antibodies	Amersham International, Amersham, UK
Protogel (acrylamide/bis-acrylamide solution)	National Diagnostics, Atlanta, Georgia, USA

2.4 Standard Solutions

2.4.1 Primary cell culture

2.4.1.1 Cell culture medium:

Dulbecco's modified Eagles's medium (DMEM): Ham's F12 1:1 supplemented with 20% heat-inactivated fetal calf serum, 1% antibiotic/antimycotic mixture, 182.5 mg/l L-glutamine, 10 ng/ml β estradiol.

2.4.1.2 Cell culture buffer:

Prepare 10mM phosphate buffered saline pH 7.4 (PBS) by dissolving tablets in distilled water to give a solution containing 2.7mM potassium chloride and 137mM sodium chloride. Autoclave prior to use.

2.4.2 Immunoassays

2.4.2.1 50mM phosphate buffered saline (PBS) pH 7.4:

7.1 g disodium hydrogen orthophosphate (anhydrous)

6.8 g potassium dihydrogen orthophosphate (anhydrous)

8.8 g sodium chloride

1.0 g sodium azide

Dissolve in 1 litre of distilled water. Adjust to pH 7.4 with sodium hydroxide.

2.4.2.2 IGFBP-1 assay buffer:

50mM PBS pH 7.4 containing 10% (v/v) heat-inactivated horse serum.

2.4.2.3 PP14 assay buffer:

50mM PBS pH 7.4 containing 1% (w/v) bovine albumin.

2.4.2.4 *7.5% and 15% polyethylene glycol (PEG) solutions:*

Dissolve PEG 6000 in 50mM PBS to give 7.5% and 15% (w/v) solutions.

2.4.3 Immunocytochemistry and immunohistochemistry

2.4.3.1 *50mM Tris buffered saline pH 7.4:*

50mM Tris.HCl

375mM NaCl

Adjust to pH 7.4 with NaOH

2.4.3.2 *1% paraformaldehyde with 0.1% glutaraldehyde solution:*

1% (v/v) of paraformaldehyde and 0.1% (v/v) glutaraldehyde in 0.125M phosphate buffer pH 7.3.

2.4.4 Thin Layer Chromatography

2.4.4.1 *Concentrated chromic acid wash:*

Dissolve 75g of sodium dichromate in 100 mls of distilled water followed by 1300 mls of concentrated sulphuric acid.

2.4.4.2 *Solution for the extraction of total lipids:*

1:2 v/v chloroform:methanol

2.4.4.3 *Solution for the extraction of total lipids with an increased extraction of polar phospholipids:*

200:400:5:1.6 v/v chloroform:methanol:concentrated HCl:0.5M EDTA

2.4.4.4 *Total lipid TLC solvent system:*

25:25:25:10:9 v/v methyl acetate:chloroform:n-propanol:methanol:0.25% (w/v) potassium chloride.

2.4.4.5 *Potassium oxalate solution:*

1% w/v potassium oxalate in distilled water.

2.4.4.6 *Phosphoinositide TLC solvent system:*

48:40:7:5 v/v chloroform:methanol:water:concentrated ammonia.

2.4.4.7 *Glycerol TLC solvent system:*

180:40:6:4 v/v hexane:ether:methanol:acetic acid.

2.4.5 SDS-PAGE

2.4.5.1 *Lysis buffers:*

a) Morris White buffer (2x) pH 7.4

To make 100 ml:

6 ml	sodium chloride (5 M)
2 ml	sodium vanadate* (20 mM)
20 ml	sodium pyrophosphate (100 mM)
40 ml	sodium fluoride (500 mM)
400 µl	EDTA, pH 8.0 (500 mM)
300 µl	magnesium chloride (1 M)
2.383 g	HEPES
20 ml	glycerol

Make up to 100ml with distilled water and pH to 7.4.

*to prepare sodium vanadate (Na_3VO_4) solution adjust pH to 10, boil until solution turns colourless and store at room temperature.

b) Working lysis/wash buffer

To make 10 ml:

5 ml	Morris White buffer (2x)
100 µl	Triton X-100
(10 µl	Triton X-100 for wash buffer)
100 µl	100 mM PMSF (prepared in 100% isopropanol)
10 µl	aprotinin (3 mg/ml)
10 µl	leupeptin (1 mg/ml)

Make up to 10ml with distilled water.

2.4.5.2 SDS-PAGE buffers:

a) Loading buffer pH 6.8

2%	sodium dodecyl sulphate (w/v)
100 mM	Tris.HCl pH 6.8
0.05%	Bromophenol blue (v/v)
30%	glycerol (v/v)
100 mM	dithiothreitol (DTT)

b) Separating/resolving gel buffer pH 8.8

750 mM	Tris.HCl pH 8.8
0.2%	SDS (w/v)

c) Stacking buffer pH 6.8

250 mM	Tris.HCl pH 6.8
0.2%	SDS (w/v)

d) Running buffer

25 mM	Tris base
192 mM	glycine
0.1%	SDS (w/v)

2.4.5.3 SDS-PAGE gels:

a) Separating/resolving gel

To make 30 ml of 6.5% acrylamide gel:-

6.5 ml	Protogel (30% acrylamide-bisacrylamide solution)
15 ml	Tris.SDS buffer pH 8.8
8.25 ml	distilled H ₂ O
250 µl	10% ammonium persulphate
25 µl	TEMED

b) Stacking gel

To make 15 ml of 4% acrylamide gel:-

2.0 ml	Protogel (30% acrylamide-bisacrylamide solution)
7.5 ml	Tris.SDS buffer pH 6.8
5.4 ml	distilled H ₂ O
90 µl	10% ammonium persulphate
10 µl	TEMED

2.4.6 Western blotting

2.4.6.1 Western blotting buffers:

a) Transfer buffer

25 mM	Tris base
192 mM	glycine
20%	methanol (v/v)

b) Tris buffered saline with Tween-20 (TBST)

10 mM	Tris.HCl pH 7.4
75 mM	sodium chloride
1 mM	EDTA pH 8.0
0.1%	Tween-20

c) TBST with vanadate

To make TBST with vanadate add 1 ml of 20 mM sodium vanadate to 100 ml of TBST buffer.

2.5 General Methods

2.5.1 Primary Cell Culture

The first methods of tissue and cell culture used fragments of tissue imbedded in blood plasma or lymph, mixed with embryo extract and serum. These fragments were placed on a slide or coverslip. The plasma clotted and held the tissue in place while the embryo extract and serum mixture supplied nutrients and stimulated migration of cells across the surface of the slide (Freshney 1983). The basic technique remains the same. Tissue is chopped finely (Figure 2.1a, b, c and d), rinsed and the pieces seeded onto the culture surface in a small volume of medium supplemented with a high concentration of serum. Once there is adherence of the tissue to the culture surface outgrowth of cells will follow. Large pieces of tissue can be disaggregated using enzymes, for example, trypsin or collagenase. Once cell culture is established it becomes necessary to periodically change the medium for several reasons, for example, a change in pH or an increase in cell concentration. When the cells occupy

all the culture surface or the cell concentration exceeds the capacity of the medium the culture must be divided into subcultures – a process called passaging (Figure 2.1e). The processes of changing medium and passaging are the basic steps in cell culture. (Figure 2.1a-e).

Figure 2.1 Primary culture technique

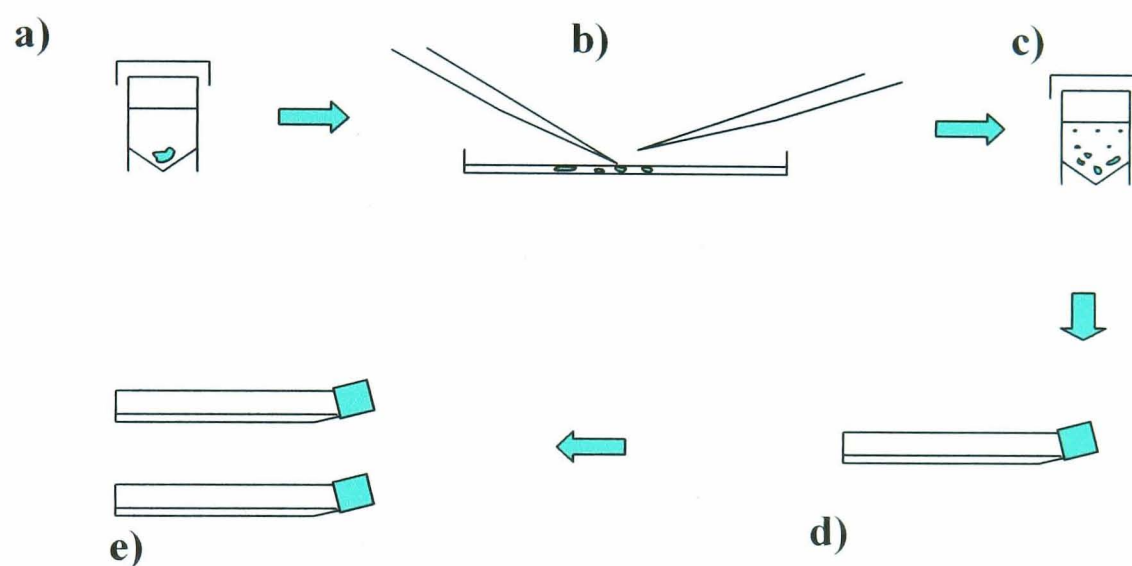

2.5.2 Immunoassays

2.5.2.1 Radioimmunoassay

Both PP14 and IGFBP-1 were measured using radioimmunoassay (RIA). The principle of RIA depends upon the compound of interest (the antigen) and a radiolabelled form of the antigen competing for binding with an antibody – which has been specifically raised against the antigen - to form an antibody-antigen complex at equilibrium (Figure 2.2)

Figure 2.2 Principle of radioimmunoassay

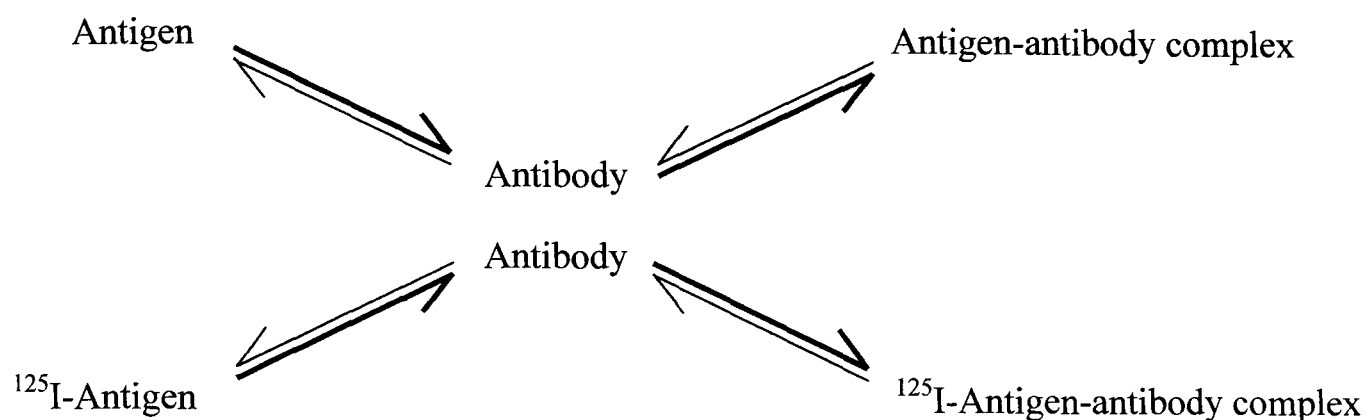

In the presence of a fixed amount of labelled antigen and antibody, as the concentration of unlabelled antigen is increased the proportion of labelled antigen bound to antibody is reduced. This antibody-bound portion of the compound may be separated from the free by a variety of methods, for example, activated charcoal and polyethylene glycol, and the amount of free or bound labelled material can be determined using a β or γ radioactivity counter. The concentration of the antigen of interest can be calculated by comparing the amount of labelled antigen bound to antibody to the amount present in samples containing known concentrations of unlabelled antigen (standards).

2.5.2.2 Enzyme-linked immunosorbent assay

The levels of cytokines were measured using commercial enzyme-linked immunosorbent assay (ELISA) kits. In ELISA systems a monoclonal antibody to the target antigen is attached to a plastic surface, in this case, to the wells of a microtitre plate. During incubation, the antigen of interest binds to the immobilised antibody. After removal of unbound material by a washing procedure, the target antigen is

bound to a second specific polyclonal antibody which is conjugated to biotin. After a second wash step the amount of biotin-conjugated monoclonal antibody is detected by a third reaction step by the addition of streptavidin-horse radish peroxidase (HRP). After removal of the unbound HRP-conjugate the wells are incubated with a substrate solution containing hydrogen peroxide and a tetramethylbenzidine buffer solution. A blue colour develops in proportion to the amount of the target antigen which is bound to the wells. The enzymatic reaction is stopped with 2N sulphuric acid and the absorbance values at 450nm are determined. A standard curve is obtained by plotting each absorbance value versus the corresponding standard value. The concentrations of the target antigen are determined by interpolation from a standard curve.

2.5.3 Thin Layer Chromatography

Thin layer chromatography (TLC) is a method which uses the differences in the way molecules behave between a mobile and stationary phase to separate components of a mixture.

The physiochemical basis of TLC separation is principally distribution equilibrium. Distribution equilibrium is a term which describes the differences in solubility and adsorption of a component in two immiscible phases.

In TLC, the stationary phase is a thin layer of adsorbent material, most commonly, silica gel, alumina or cellulose, which is applied to a flat carrier, for example, glass, aluminium or plastic. The mobile phase is an organic solvent or a specific mixture of solvents depending upon the compounds of interest. Different components in the

sample mixture travel different distances according to the strength of their attraction to the stationary phase versus the mobile phase. This separation allows for identification of components by the comparison with known standards.

2.5.4 Sodium dodecyl sulphate – polyacrylamide gel electrophoresis (SDS-PAGE)

The electrophoresis was carried out based on the method of Laemmli (1970).

Briefly, the principle of SDS-PAGE is that at a given pH the rate of migration of proteins through an electric field is dependent upon the ratio of their charge to their mass. The separation of proteins with different charge:mass ratio is achieved if the electric field is applied through a porous matrix such as polyacrylamide. When the pore size of the polyacrylamide is the same order of magnitude as the proteins to be separated molecular sieving occurs. In the case of SDS-PAGE the proteins are added to a buffer containing the ionic detergent SDS. As well as solubilising proteins allowing efficient entry into the polyacrylamide gel, binding to SDS gives the resulting SDS-protein complexes a uniform charge density. Under these conditions proteins migrate through a polyacrylamide gel according to molecular weight (Hames 1981).

A modification of this technique is discontinuous SDS-PAGE. Samples are loaded onto a stacking gel which has a different pH and pore size to the resolving gel. The stacking gel typically contains glycine/Tris HCl buffer. At pH 6.8 glycine is near to its isoelectric point and has low mobility through the gel. Chloride ions, however, have a high mobility at this pH. When the electric field is applied chloride ions migrate rapidly leaving a trailing zone which has low conductivity and a high voltage gradient. This gradient permits the accelerated migration of glycine until it reaches

the chloride ions. A steady state chloride and glycine will move at the same velocity with a sharp but narrow boundary between them. SDS-protein complexes, which have mobilities intermediate between chloride and glycine, will 'stack' within this sharp boundary until they have migrated to the resolving or separating gel. In this way, the discontinuous system allows relatively large samples to be loaded onto a gel whilst maintaining good resolution of proteins of different molecular weights (Figure 2.3).

Figure 2.3 Operation of discontinuous SDS-PAGE. (a) sample loading, (b) protein stacking and (c) protein separation. Modified from Hames (1981).

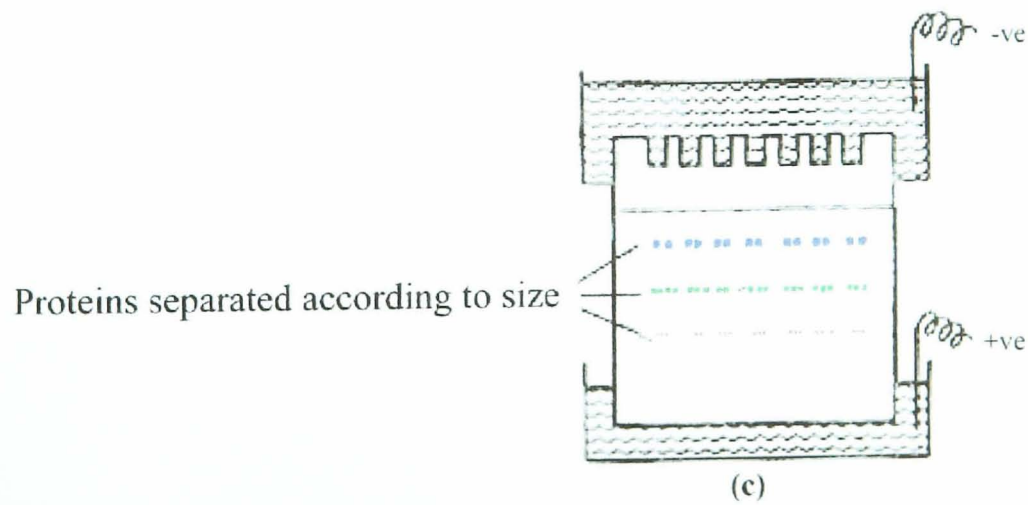
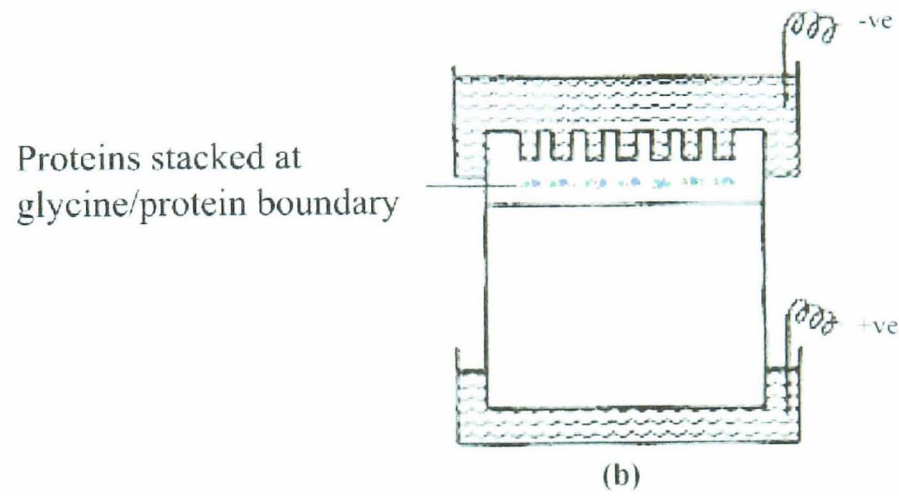
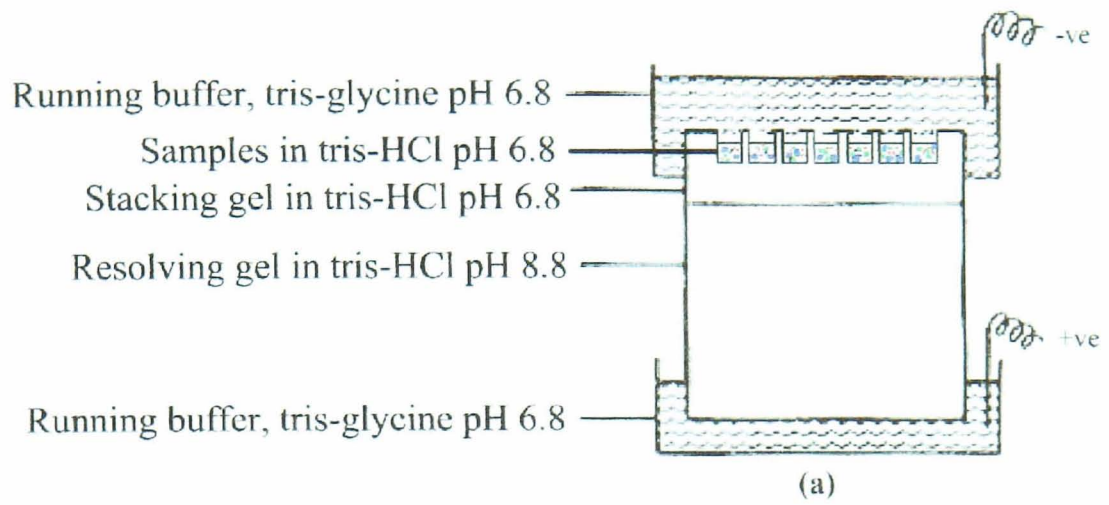

2.5.5 Western Blotting

Western blotting involves transferring proteins, previously separated by SDS-PAGE, onto polyvinylidene fluoride (PVDF) membranes. A small proportion of this protein in the membrane re-folds to its native conformation and can therefore be probed for immunoreactivity to a given antibody. Proteins contained within the polyacrylamide gel maintain a negative charge and they can be transferred onto PVDF membranes by applying a current across the gel enabling the proteins to migrate at 90 ° to the gel and onto the membrane.

Figure 2.4 Method of protein transfer

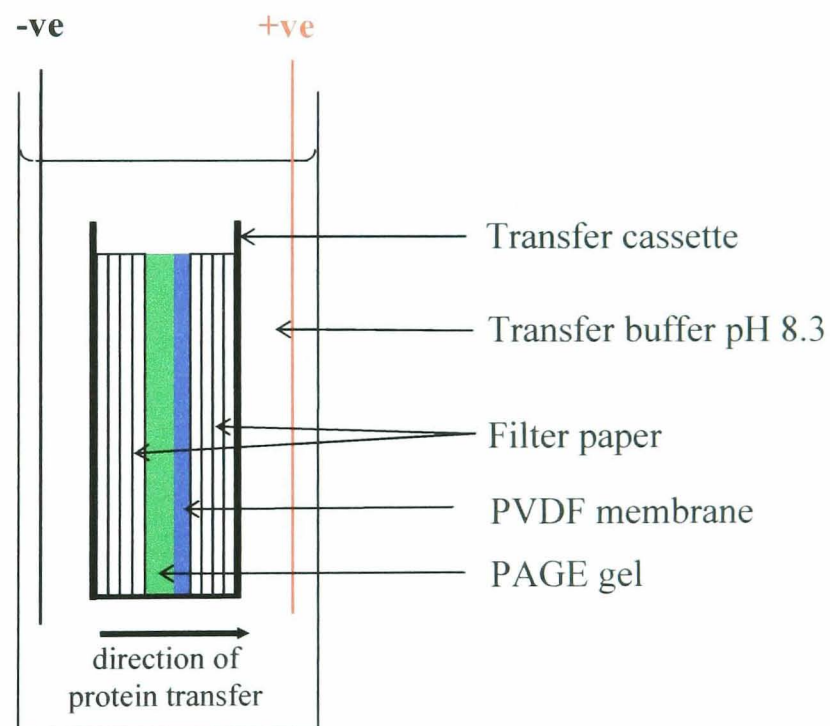
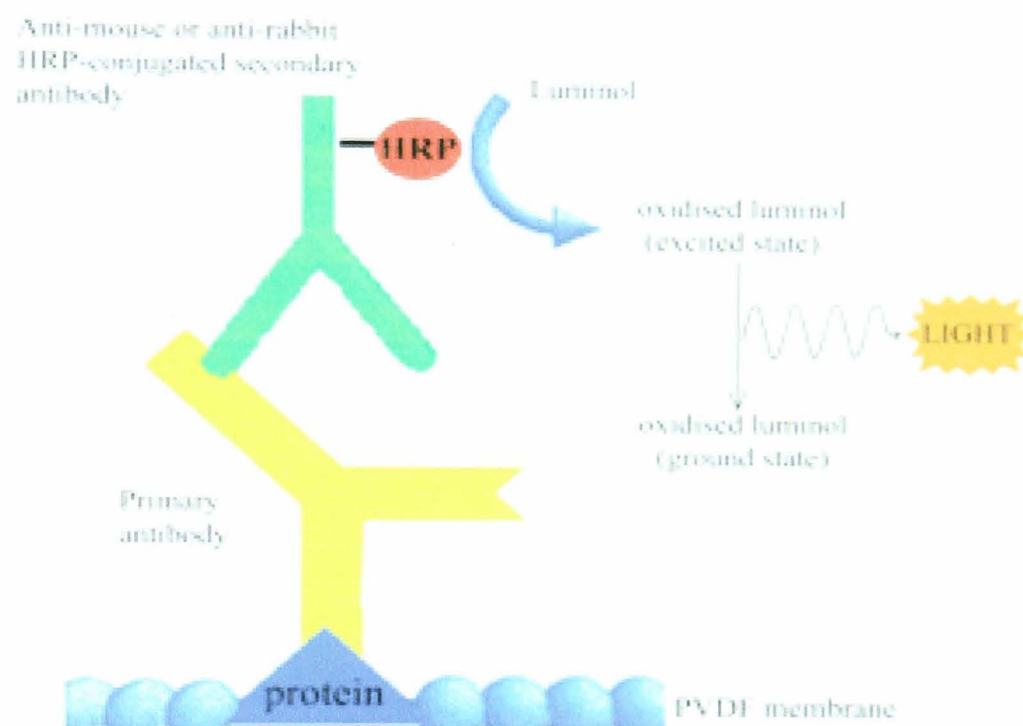

Figure 2.5 Principle of Western immunoblotting and enhanced chemiluminescence (ECL) detection.



2.6 Statistical analysis

All the data analysis was performed using the Astute programme supplied by Astute Statistical Software, DDS Software, Leeds University, UK.

CHAPTER 3

THE ESTABLISHMENT AND CHARACTERISATION OF PRIMARY ENDOMETRIAL CELL CULTURE

3.1 Introduction

In the human the endometrium lines the inner surface of the uterus and is composed of stroma and glands (Figure 3.1). The cells of the stroma, fibroblasts, are the structural support cells of the endometrium and are important in forming an interface during superficial invasion with the trophoblast of the blastocyst after implantation. The surface of the endometrium and the glands are formed from epithelial cells. The response of these cells to the hormones oestrogen and progesterone, throughout the menstrual cycle, is what determines the activity of the endometrium (Figure 3.2). Under the influence of oestradiol the endometrium of the proliferative, or follicular, phase of the menstrual cycle is characterised by sparse glands and a thin surface epithelium surrounded by a proliferating dense stroma (Figures 3.1 and 3.2). After ovulation, the secretory or luteal phase of the menstrual cycle begins and the endometrium becomes exposed to progesterone from the corpus luteum causing the glands to enlarge and become secretory and the stroma to expand due to the uptake of fluids combined with tissue oedema (Figure 3.2).

The studies in this thesis required consecutive experiments to be performed in the same batch of endometrial cells so as to maintain experimental consistency. It was therefore necessary (i) to establish a long term culture system for primary endometrial cells and (ii) to maintain the viability and function of these cells in culture.

Short term cell culture of endometrial cells has been well documented (Chen et al 1995; Laird et al 1996; Laird et al 1997). For long term culture it has been common practice to use cell lines derived from endometrial adenocarcinomas (Fleming 1999) but as these cells have been transformed they are not representative of normal endometrial cells.

Figure 3.1 The human proliferative endometrium showing stromal and epithelial cells. The proliferative stage of the menstrual cycle is characterised by sparse glands and a thin surface epithelium surrounded by dense stroma. The stromal cells or fibroblasts are the structural support cells and the predominant cells of the endometrium. The stromal cells are also important in forming an initial interface with the trophoblast of the blastocyst at implantation. (Llewellyn-Jones 1978).

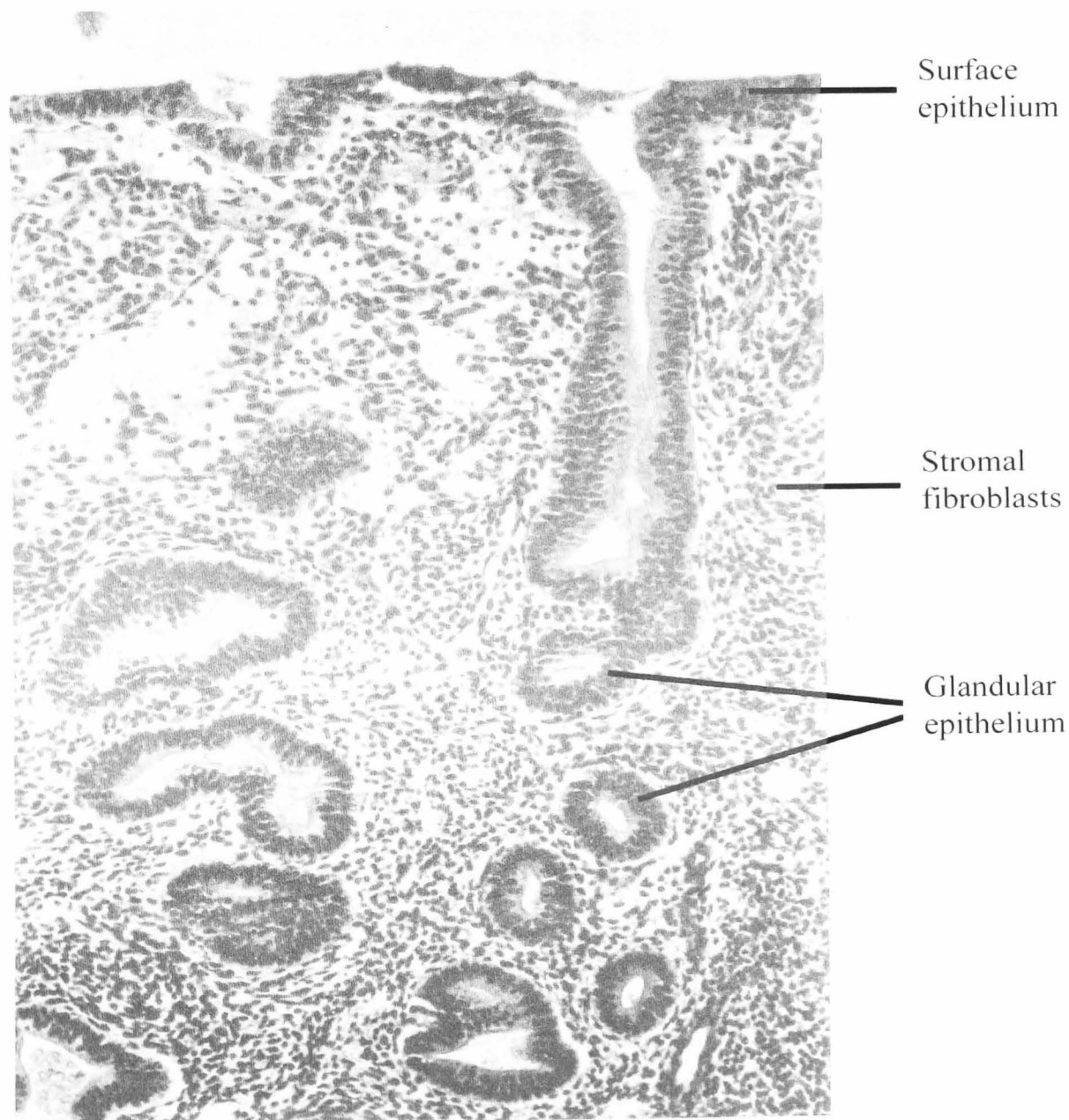
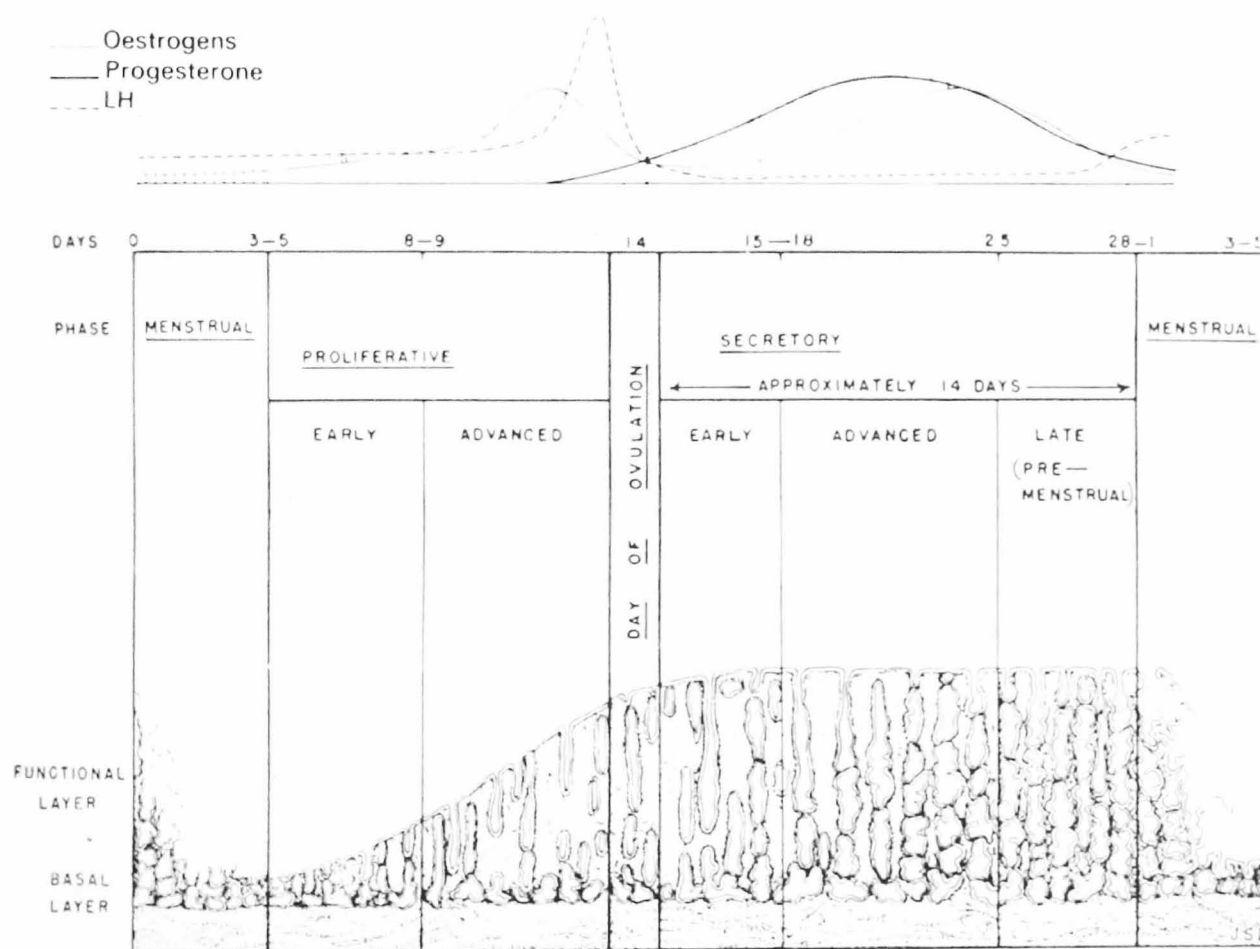

Figure 3.2 Diagram showing hormonal and endometrial changes which occur throughout the human menstrual cycle. Modified from Johnson and Everitt (1988).



To overcome these problems long-term primary human endometrial cell culture was established.

For this study both proliferative and secretory derived endometrial cells were cultured in a media supplemented with only one hormone, oestradiol (10ng/ml). Although tissue taken from the secretory phase would have already been exposed to progesterone this was not included in the media as, *in vitro*, this leads to decidualisation of the endometrial tissue (Irwin et al 1989). Decidua is 'pregnancy' endometrium and would have been inappropriate for this study.

To confirm that the cultured cells from the excised tissue maintained some degree of the differentiated state that they acquired *in vivo*, measurement of proteins characteristic of that state was carried out. PP14 and IGFBP-1 measurements were carried out to confirm the function and characterisation of the endometrial cells in culture as both have been used in the past as markers of endometrial cell function (Fay et al 1990 and Giudice et al 1991 respectively) and are produced in greater quantity in the cells of endometrial tissue obtained from the secretory phase of the cycle compared with those of the proliferative phase.

3.1.1 Placental Proteins

3.1.1.1 Placental Protein 14: epithelial cell marker

PP14, also termed glycodelin (Seppala 1999), is a glycoprotein with a molecular weight of 42,000 to 43,000 Daltons (Bohn et al 1982) and a structural homology with β -lactoglobulin (Huhtala et al 1987). The exact function of PP14 in the endometrium is not clearly understood but it has been found to inhibit sperm-zona pellucida binding in a dose-dependent manner suggesting it may play a role in the process of

fertilisation (Oehninger et al 1995). It has also been shown to have immunosuppressive properties and therefore may have a role in the suppression of the maternal immune system during implantation (Bolton et al 1987, Pockley et al 1988, Okamoto et al 1991) which may account for its marked increase in production in the endometrium around the time of implantation and throughout the following secretory phase. It is the protein most commonly used as a marker of endometrial function *in vivo* and *in vitro* (Fay et al 1990). There is some dispute as to whether it is specifically secreted by the endometrium or is also secreted by the ovary (Seppala et al 1985). However, there is further evidence which suggests that it is solely synthesised by the glandular epithelium (Olajide and Chard 1992; Borri et al 1998) which makes it an ideal candidate for confirming morphology and cell function of endometrial epithelial cells.

3.1.1.2 Insulin-like growth factor binding protein-1: a stromal cell marker

IGFBP-1, formerly known as placental protein 12 (PP12), is a 25,000 Daltons non-glycosylated protein identified from placental extracts by Bohn and colleagues in 1982. It is believed to modulate acute changes of serum insulin-like growth factors (IGFs) (Wang and Chard 1992; Hills and Chard 1995). IGFBP-1 mRNA is not detected in proliferative phase endometrium but is present in the stromal cells of the secretory endometrium (Julkunen et al 1990; Zhou et al 1994). After ovulation increasing levels of progesterone stimulate the stromal cells to secrete IGFBP-1 (Lui et al 1997).

3.2 Methods

3.2.1 Collection of endometrial tissue

Samples of endometrial tissue were obtained from the histopathology department at St Bartholomew's Hospital, London. The tissue was removed from the uteri of premenopausal women who had undergone hysterectomy for conditions not associated with endometrial malignancy. The tissue was collected into culture medium within 1-2 hours of excision.

The phase of the menstrual cycle was determined by clinical history and histological examination when the endometrium was classified as proliferative, secretory, mid-cycle or inactive. The classification was carried out by the duty histopathologist in the Department of Histopathology, St Bartholomew's Hospital, London, UK.

The study was approved by the local Ethics Committee and informed consent was given by each patient prior to surgery.

3.2.2 Preparation and culture of endometrial cells

The preparation and culture of cells from endometrial tissue was carried out according to a modified method of Freshney (1983) and Chatziki et al (1994).

The resected endometrial tissue was collected into 1:1 Dulbecco's modified Eagle's medium (DMEM) and Ham's F12 mixture supplemented with 20% heat-inactivated fetal calf serum, 1% antibiotic/antimycotic mixture, 182.5 mg/l L-glutamine and 10 ng/ml β estradiol and stored at 4°C unless it was to be processed immediately.

All the following tissue and cell manipulations were carried out in an MDH Class II laminar flow cabinet. The cells were cultured in a closed flask system which reduces infection and cross-contamination within the incubator.

Single cell suspensions of endometrial cells were obtained by mechanical disruption of the endometrial tissue using scalpels in 10 ml of medium. The single cells were separated from larger clumps of tissue by sedimentation. The resulting supernatant containing the finer material was panned out into a 25 cm² flask, gassed for 20 seconds using a 95% air and 5% carbon dioxide mixture and placed in a 37°C incubator.

Cell aggregates from the sedimentation pellet were digested with collagenase (Type II-S, 200 units/ml) at 37°C for 2 hours. The cells were then washed twice with 10mM PBS, resuspended in medium and panned as previously described.

Cell growth was monitored daily using a phase-contrast microscope and the medium was changed either at confluence, that is, when the cells cover one complete surface of the flask, at which point passaging took place or when the medium was spent – about every 3-5 days. All conditioned media was stored at -20°C.

When passaging was required the medium was either discarded or stored as previously mentioned and the cells washed twice with 5 to 10 ml of sterile 10mM PBS depending upon the surface area of the flask. Three mls of trypsin:EDTA, previously diluted 1:10 in PBS, were added to the flask which was returned to the 37°C incubator for up to 20 minutes during which time the cells lift off from the flask surface. Addition of 7 ml of media containing fetal calf serum stops further trypsinisation. The suspended cells were then divided equally into two new flasks to which fresh media was added to the required amount.

The flasks were gassed and returned to the incubator as previously described.

3.2.3 Cell number determination

A cell count was obtained by taking a small amount of the cell suspension during passaging and using the Improved Neubauer haemocytometer to calculate the number of cells in a flask. The number of cells can be derived by employing the formula:

$$c = n/v$$

where c is cell concentration as cells/ml, n is number of cells counted and v is volume counted. For the Improved Neubauer slide the depth of the chamber is 0.1 mm and assuming only the central 1 mm² is used $v = 0.1 \text{ mm}^3$ or 10^{-4} ml and the formula becomes $c = n \times 10^4$. The average of three counts was calculated.

3.2.4 Cell viability

Cell viability was assessed using 0.4% Trypan blue solution and observing the uptake of the stain into the cells. This test relies on the controlled permeability of living cells and the exclusion of certain dyes (Kaltenbach et al 1958). Cell death with consequent breakdown in membrane integrity results in uptake of Trypan blue into the cell.

Cells were grown to confluence in a 25 cm² flask. At this point each flask contained approximately 1×10^6 cells. The medium was removed and the cells washed with 10mM PBS followed by the addition of 4 ml of a 1:1 solution of Trypan blue in PBS. After 5 minutes the stain was discarded and the number of cells which had taken up the dye was counted by microscopy and recorded as the percentage non-viable. Viable cells, with intact membranes, exclude the dye.

3.2.5 Cell characterisation

3.2.5.1 Cell morphology

Stromal and epithelial cells were grown in separate flasks and their morphology was confirmed by histological examination using a Hoffmann phase-contrast microscope.

3.2.5.2 Immunocytochemistry

Stromal and epithelial cells were further identified using antibodies against specific cell markers.

Immunocytochemical staining of endometrial cells was carried out after 5 days in culture using anti-cytokeratin, an epithelial cell marker, and anti-vimentin, a stromal cell marker.

Cells were grown onto sterile glass cover slips which were pre-treated with poly-L-lysine (0.1 mg/ml solution) to aid cell adhesion. The cells were fixed after 5 days of growth using increasing percentages of methanol until 100% methanol was reached.

The cells were then incubated with either:

- a) anti-cytokeratin at a dilution of 1:50 in 10 mM PBS
- b) anti-vimentin at a dilution of 1:100 in 10 mM PBS

for 2 hours at room temperature. The first antibody was then washed off with PBS and replaced with rabbit anti-mouse IgG antibody at 1:20 in PBS for 30 minutes at room temperature. After a further wash with PBS the cells were incubated with anti-alkaline phosphatase complex at 1:20 for 30 minutes at room temperature. The cells were finally incubated with the enzyme substrate Fast Red (1 mg/ml) for 15 minutes.

3.2.6 Cell function

The function of primary human endometrial cells in culture was assessed by measuring placental protein 14 (PP14) and insulin-like growth factor binding protein-1 (IGFBP-1) levels, by radioimmunoassay, in samples of conditioned media from cells cultured for up to 31 days from seeding. The materials and methods used are described in sections 2.3.2, 3.2.6.1 and 3.2.6.2.

The proteins, PP14 and IGFBP-1, were assayed in media removed from the culture flasks containing endometrial cells at the time of passaging. The culture of endometrial cells is described previously in Section 3.2.2.

3.2.6.1 Radioimmunoassay for PP14

PP14 was measured using a method similar to that described by Bolton *et al* (1983). To 100µl of each standard (0, 10, 20, 50, 100, 200 and 500µg/l PP14 prepared in horse serum) or sample were added 100µl ¹²⁵I-PP14 (10,000 cpm) prepared according to the chloramine T method of Greenwood *et al* (1963) and 100µl of antibody at an initial dilution of 1:10,000. Tubes containing assay diluent in place of antibody (assay blank or non-specific binding) and tracer alone (total counts) were set up. Three quality control serum pools which gave low, medium and high levels of PP14 were included in each assay. All tubes were set up in duplicate and incubated either overnight at room temperature or for 48 hours at 4°C. To separate bound and free antigen 50µl normal rabbit serum at an initial dilution of 1:50, 100µl anti-rabbit serum at an initial dilution of 1:20 and 500 µl of 7.5% polyethylene glycol (PEG) 6000 were added to the incubation mixture. The assay was pre-incubated for 30 mins at room temperature before centrifuging at 18°C for 30 mins at 1800 x g. The supernatant was

aspirated and the precipitate containing the bound fraction was counted on a gamma counter.

All dilutions were carried out using 50mM PBS containing 1% bovine serum albumin.

3.2.6.2 Radioimmunoassay for IGFBP-1

IGFBP-1 was measured as previously described by Wang et al (1991). To 100µl of each standard (0, 0.5, 1, 2, 5, and 10µg/l IGFBP-1 prepared in 50mM PBS with 10% v/v heat inactivated horse serum) or sample 100µl of antibody at an initial dilution of 1:800 were added and incubated for 5 hours at room temperature. Tubes for non-specific binding, total counts and quality controls were also set up. 50µl of ¹²⁵I-IGFBP-1 (3000 cpm) were added to the incubation mixture and incubated overnight at room temperature. To separate bound and free antigen 1ml of 15% PEG and 100µl of heat inactivated horse serum was used. The tubes were then centrifuged, aspirated and counted as previously described for the PP14 assay.

All dilutions were carried out using 50mM PBS containing 10% v/v heat inactivated horse serum.

The intra- and interassay coefficients of variation of both protein assays were less than 10%.

3.3 Statistical analysis

Levels of proteins from the culture of cells from proliferative and secretory endometrium were not normally distributed (Kolmogorov-Smirnoff test $p < 0.05$) and therefore it was necessary to compare the groups using the Wilcoxon Mann Whitney U-test.

In all cases, differences between the groups were considered significant when the probability of the events occurring by chance was < 0.05 .

3.4 Results

3.4.1 Cell Culture

Primary human endometrial cells from the proliferative and secretory phase of the menstrual cycle were successfully cultured and some cultures remained viable for at least 60 days from initial seeding.

3.4.2 Cell viability

At confluence each 25cm² flask contained approximately 1×10^6 cells of which 99.9% were considered viable according to Trypan blue staining (Figure 3.3)

3.4.3 Cell morphology

Using a phase contrast microscope it was evident that both glandular epithelial and stromal fibroblasts had been cultured (Figure 3.4).

Anti-vimentin and anti-cytokeratin staining revealed that the cell cultures were enriched with stromal cells from day 7 (Figure 3.5).

Figure 3.3 Trypan blue uptake by human endometrial cells used as a test for cell viability. Arrows indicate cells which have taken up the dye. Cells stained with Giemsa. Magnification x 200.

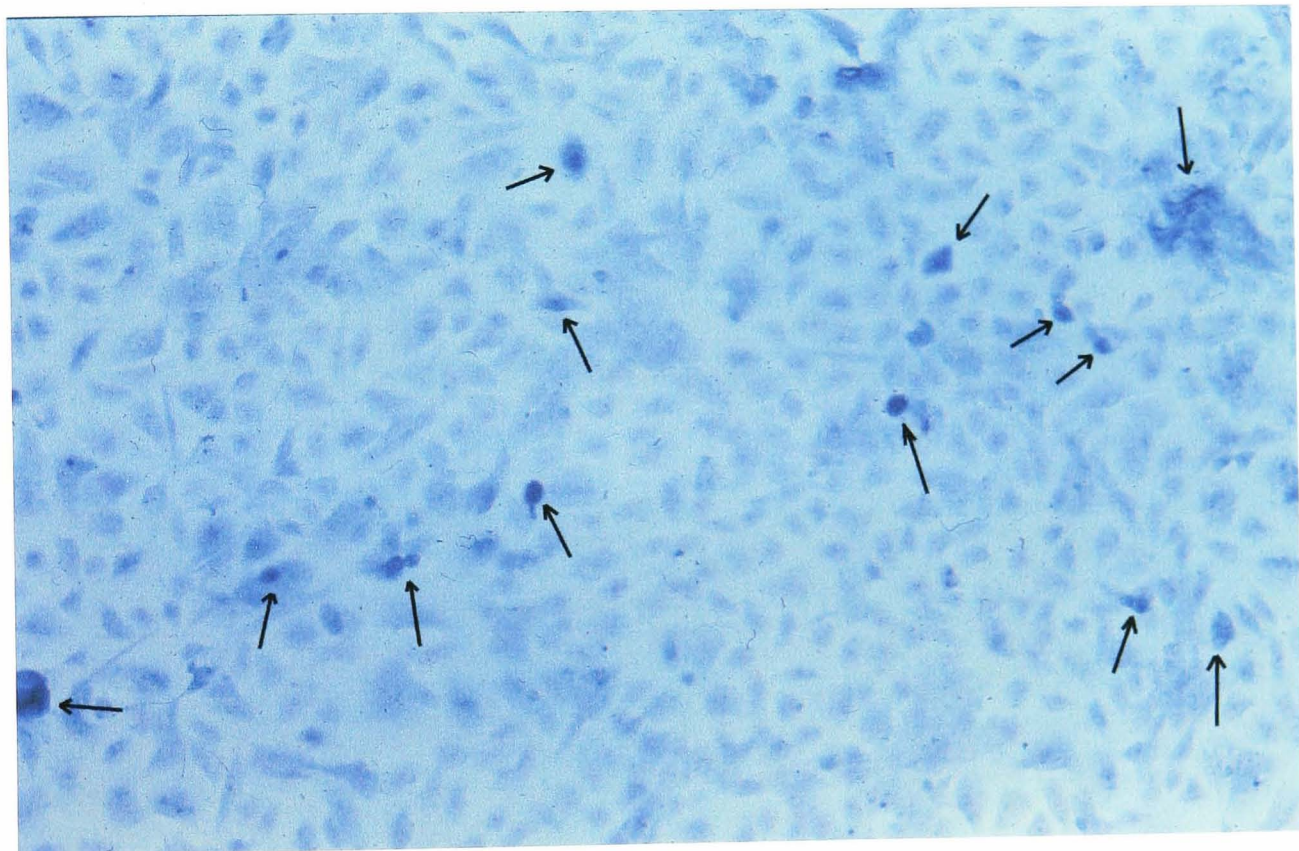

Figure 3.4 Primary human endometrial epithelial (A) and stromal (B) cells at 8 days of culture. Magnification x 200.

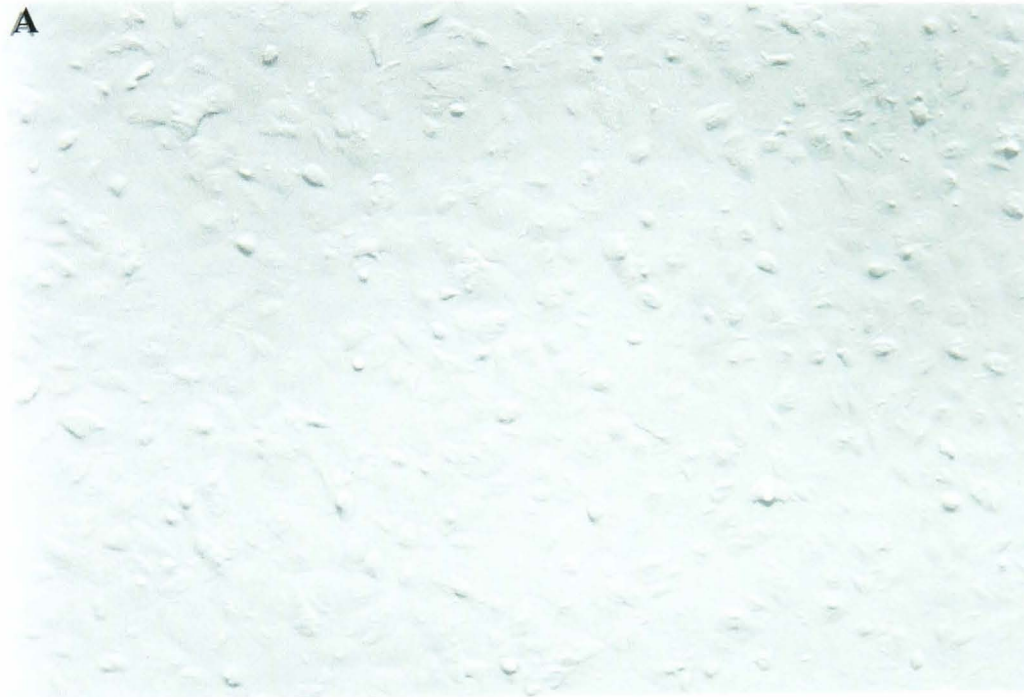
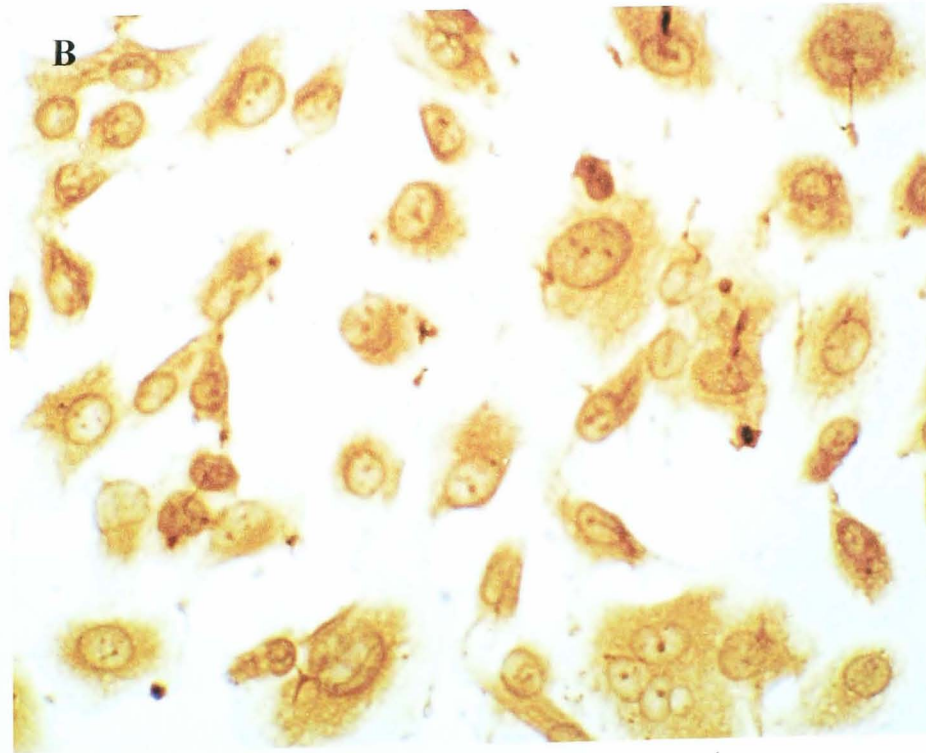
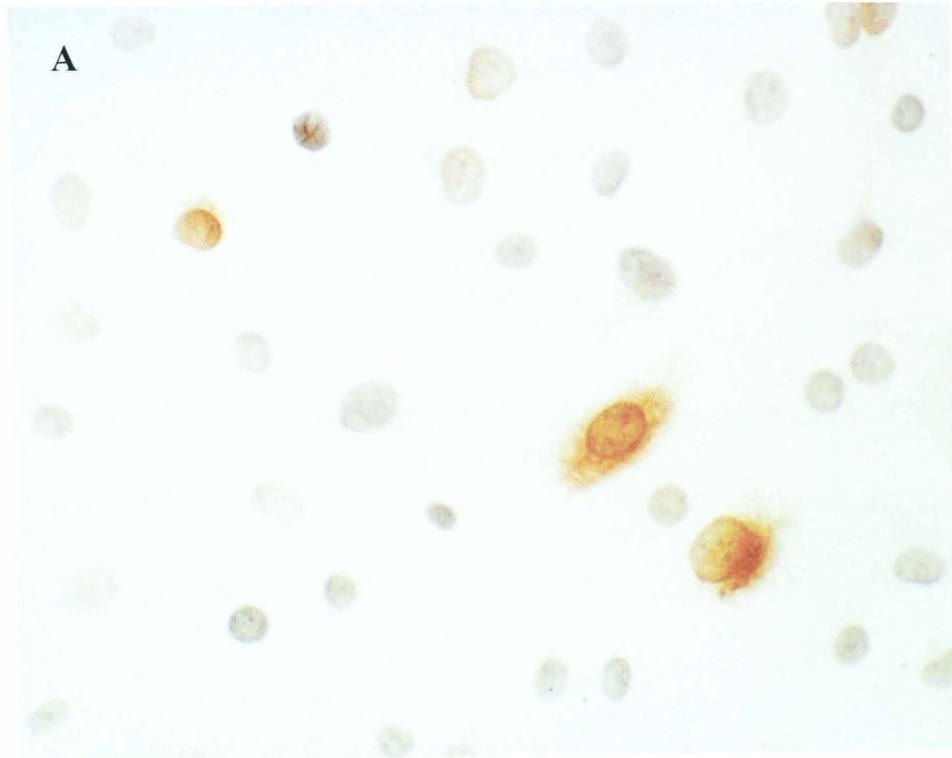

Figure 3.5 Epithelial cell marker, anti-cytokeratin (A), and stromal cell marker, anti-vimentin (B) staining of human endometrial cells after 7 days in culture. Magnification x 400.



3.4.4 Cell function

3.4.4.1 PP14

Measurable levels of PP14 were detected in the conditioned media from primary endometrial cells obtained from both the proliferative and secretory phases of the menstrual cycle. Figure 3.6 show graphs of PP14 levels throughout culture in both proliferative and secretory phase cells from individual tissues. Levels of PP14 were found to be almost 17 times higher ($p = <0.01$) in the supernatants from secretory phase cells than those from proliferative phase cells during the first 5 days in culture. Release of PP14 from both proliferative phase and secretory phase cells declines over time in culture. By day 16 the difference in PP14 levels between proliferative and secretory phase levels was no longer significant (see Table 3.1).

3.4.4.2 IGFBP-1

Conditioned media from cultured cells from the secretory phase of the menstrual cycle had measurable levels of IGFBP-1 which decreased over time (Figure 3.7) but, in the media from cultured proliferative phase cells, levels of IGFBP-1 remained undetectable throughout cell culture (see Table 3.1), being below the limit of detection of the assay ($<0.5 \mu\text{g/l}$).

Table 3.1 *In vitro* concentrations of PP14 and IGFBP-1 (total mass in ng) produced by primary endometrial cells taken from the proliferative and secretory phases of the menstrual cycle.

		Proliferative phase	secretory phase	
Protein	days from seeding (n)	Median (range)(ng)	median (range)(ng)	p value
PP14	0 – 5 (5)	185.7 (29.4 – 242.9)	964.3 (250.0 – 8758.0)	0.009
	6 – 10 (5)	117.3 (29.4 – 323.7)	658.1 (250.0 - 964.3)	0.028
	11 – 15 (4)	95.6 (29.4 – 227.6)	317.8 (220.0 - 810.4)	0.043
	16 – 20 (4)	111.8 (56.0 – 166.7)	136.8 (82.4 - 195.0)	0.480
	21 – 25 (4)	58 (56.0 – 120.0)	112.0 (17.0 - 165.0)	0.470
	26 – 30 (4)	63 (58.0 – 80.0)	51.0 (17.0 - 128.0)	0.290
IGFBP-1	0 – 5 (4)	undetectable	617.8 (3.1 – 3611)	0.021
	6 – 10 (4)	“	555.8 (2.4 – 3675)	“
	11 - 15 (4)	“	54.9 (1.1 – 3928)	“
	16 – 20 (4)	“	137.5 (3.7 – 829)	“
	21 – 25 (4)	“	65.0 (4.8 – 130)	“
	26 – 30 (4)	“	22.0 (0.6 – 54.0)	“

(Cells seeded at 10^6 per 25cm^2 flask)

(p value indicates the difference between proliferative and secretory endometrial cells using the Mann Whitney U test)

Figure 3.6 *In vitro* concentrations of PP14 (total mass in ng) produced by primary endometrial cells taken from the proliferative and secretory phases of the menstrual cycle. Error bars represent maximum and minimum values. * significant difference between proliferative and secretory phases ($p < 0.05$).

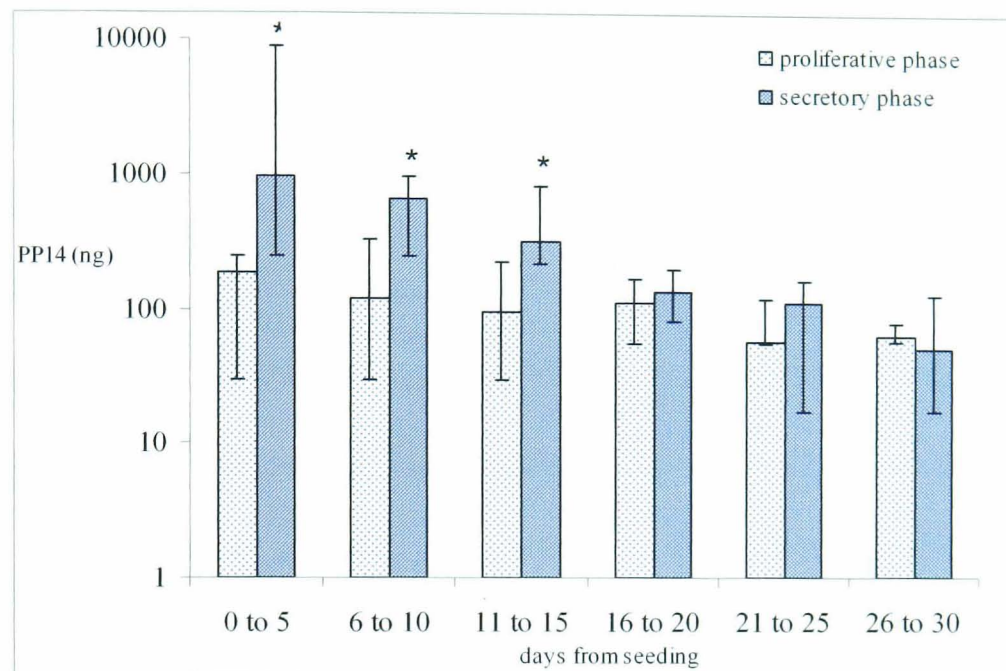
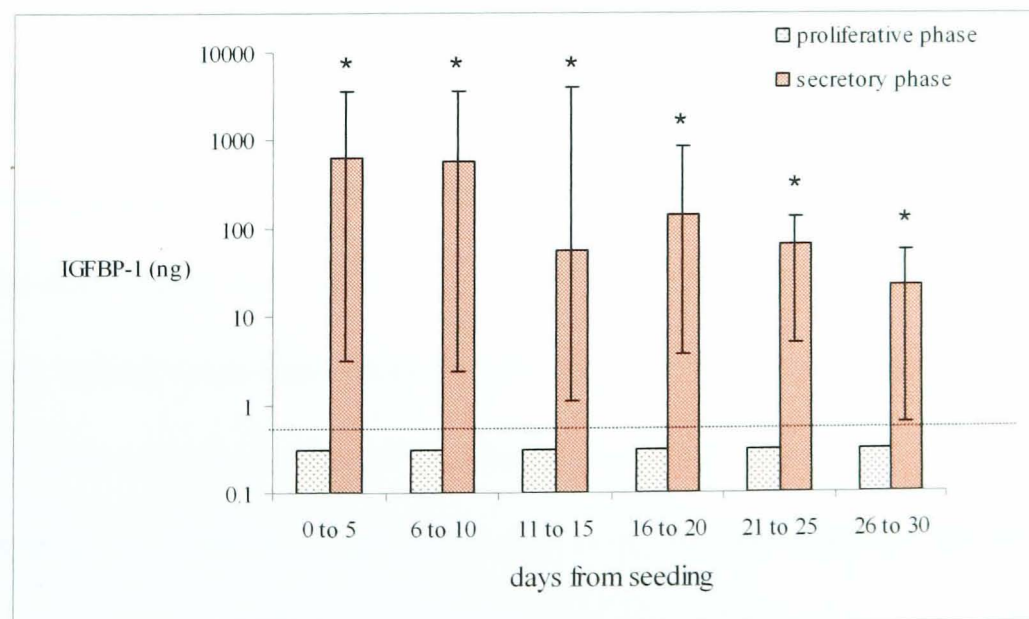

Figure 3.7 *In vitro* concentrations of IGFBP-1 (total mass in ng) produced by primary endometrial cells taken from the proliferative and secretory phases of the menstrual cycle. Error bars represent maximum and minimum values. * significant difference between proliferative and secretory phases ($p < 0.05$). Dotted line represents limit of detection.



3.5 Discussion

The results of the measurement of proteins and cytokines produced by the primary human endometrial cells grown for this study indicate that the culture consists of a mixed population of both stromal and epithelial cells with stromal fibroblasts being the predominant cell type from day 8 onwards. For the most part, these cells are producing proteins characteristic of that cell type and the phase of the menstrual cycle from which they have been taken.

Production of PP14 shows that epithelial cells from both phases of the cycle are present in the culture with production being significantly higher in the secretory phase cells and this is in agreement with the literature (Laird et al 1993; Julkunen et al 1986; Wood et al 1989; Laird et al 1995). The production of PP14 becomes non-significant after the first 15 days of culture. *In vivo* production of PP14 is stimulated by progesterone (Julkunen et al 1986; Wood et al 1989) and it has been shown that progesterone also stimulates PP14 production by endometrial cells *in vitro* (Taylor et al 1998; Bersinger et al 1995; Laird et al 1993). However, in this study the media was not supplemented by progesterone (see section 3.1) and this may account for the reduction in PP14 production by the secretory phase cells in culture.

IGFBP-1 is a protein which is very phase-specific being secreted solely by stromal cells of the secretory phase of the menstrual cycle. The results show that there were stromal cells present in the secretory phase cell culture producing IGFBP-1. However, the proliferative phase cell culture did not produce detectable levels of IGFBP-1. It would seem unlikely that there were no stromal cells present in the proliferative phase culture but these cells *in vitro* were representative of those *in vivo* in that stromal cells of the proliferative phase of the menstrual cycle do not produce IGFBP-1. Post

ovulation it is the increased levels of progesterone which stimulate the stromal cells to produce IGFBP-1 (Liu et al 1997). The secretory phase cells in this study show a reduction in production of IGFBP-1 over time with a large decrease in production from day 16 onwards. This reduction may be due to the lack of progesterone in the culture medium which has been observed by Bell et al (1991). The reduction in production of IGFBP-1 in response to a lack of progesterone is similar to the pattern of PP14 production.

CHAPTER 4

CYTOKINE PRODUCTION BY ENDOMETRIAL CELL CULTURES

4.1 Introduction

Many of the events that occur in the endometrium during the normal menstrual cycle and early pregnancy are reminiscent of the processes of inflammation (Epifanova 1971) and repair (Ferenczy et al 1979). It is therefore not surprising that there is evidence for a close involvement of cytokines in these tissues (Arai et al 1990; Wolvekamp et al 1990; Chard and Rice 1998). Hypotheses include the possibility that they modulate the maternal immune response to the invading embryo-derived trophoblast during implantation.

4.1.1 Cytokines

4.1.1.1 Leukaemia inhibitory factor (LIF)

LIF is a 38-67 kDa glycoprotein and was initially characterised by its ability to induce differentiation of mouse myeloid leukaemia M1 cells into macrophages (Gearing et al 1987). Since then LIF has been found to have many activities in various tissues and cell types including the suppression of differentiation of normal embryonic stem cells (Williams et al 1988; Smith et al 1992). In mice LIF is expressed in large quantities at the time of implantation (Bhatt et al 1991) and implantation fails to occur in mice with deletion of the LIF gene (Stewart et al 1992). Synthesis of LIF by human endometrial cells in culture has been observed (Chen et al 1995; Laird et al 1997). It has been shown that LIF mRNA expression in human endometrium changes during the menstrual cycle and that expression in endometrial glandular epithelial cells is much greater than that by stromal cells (Kojima et al 1994).

4.1.1.2 Interleukin 6

Interleukin 6 (IL6) is one of a family of proteins typically produced by T lymphocytes and macrophages. Endometrial IL6 is heterogenous and consists of isoforms in the size range 23-30 kDa (May et al 1988). IL6 has been found to stimulate trophoblast *in vitro* to produce human placental lactogen (hPL) (Stephanou and Handwerger 1994) and human chorionic gonadotrophin (hCG) (Nishino et al 1990). Cultured human endometrial stromal cells can be stimulated to produce IL6 by a number of inflammatory-associated cytokines, for example, TNF α and IFN γ and modulated by oestrogen (Tabibzadeh et al 1989). Other studies have shown that both epithelial and stromal endometrial cells can secrete IL6 and the levels vary according to the phase of the menstrual cycle (Laird et al 1993).

4.1.1.3 Tumour necrosis factor α

Tumour necrosis factor α (TNF α) is a 17kDa protein which exerts a variety of effects ranging from proinflammatory and cytotoxic to growth and immunomodulatory in many different types of cells. It has been suggested that TNF α secreted during the secretory and menstrual phases plays a role in induction of programmed cell death in these cells (Tabibzadeh et al 1995). It will stimulate the production of IL6 in trophoblastic cells (Li et al 1992) and will induce interferon β production in human endometrial stromal cells (Tabibzadeh et al 1989) and dissociation of human endometrial epithelial cells (Tabibzadeh et al 1995). TNF α has been shown to be present within stromal, epithelial and leukocyte cells of the human endometrium (Tabibzadeh 1991a; Tabibzadeh 1991b; Hunt et al 1992) with the majority of it present in the glandular epithelial cells (Garcia et al 1994). The factors controlling

TNF α production are not clearly understood and studies show conflicting results as to the pattern of its production. Some have suggested that TNF α levels increase during the secretory phase of the menstrual cycle (Philippeaux and Piguet 1993; Tabibzadeh et al 1995) while others have shown an increase during the late proliferative phase (Hunt et al 1992; Laird et al 1996).

4.1.1.4 Hepatocyte growth factor

Hepatocyte growth factor, or scatter factor, is a heparin-binding glycoprotein consisting of two subunits, a 60 kDa α -chain and a 32 or 36 kDa β -chain, linked by disulphide bonds and shares a 38% structural homology with plasminogen (Gherardi et al 1989; Weidner et al 1991). HGF is the most potent mitogen for hepatocytes in primary culture (Nakamura et al 1984) and is considered the major mediator of liver regeneration *in vivo*. The human liver has a tremendous regenerative capacity and in response to hepatic resection the hepatocyte, under the influence of mitogenic cytokines like HGF, can proliferate to restore the liver to its original mass. HGF not only stimulates the growth of hepatocytes and renal tubular epithelial cells but is produced by non-parenchymal cells in both the liver and kidney suggesting a role as a paracrine effector of cell-cell interactions (Gherardi and Stoker 1991).

HGF has been shown to stimulate the proliferation, migration and morphogenesis of endometrial epithelial cells (Sugawara et al 1997; Negami et al 1995) and is considered to be involved specifically in the regeneration or reconstruction process of the endometrium after menstrual shedding (Negami et al 1995). The nature of endometrial tissue regeneration following menstruation is poorly understood.

However, as the endometrium is a regenerative tissue, undergoing regeneration every month, and HGF is able to stimulate regeneration of the liver, levels of HGF, produced by human endometrial cells *in vitro*, were measured.

4.1.1.5 Interferon γ

Interferon γ , the immune interferon, is a type II interferon – one that is labile at pH 2 - produced by a variety of cells, in particular T-cell lymphocytes, following antigenic (viral) or mitogenic stimulation.

IFN γ is a 45 kDa heterodimeric molecule consisting of one subunit of 25 kDa and one of 20 kDa (Yip et al 1982). It is a pleiotropic cytokine involved in the regulation of nearly all phases of immune and inflammatory responses including the activation, growth and differentiation of T cells, B cells, macrophages, natural killer (NK) cells and other cell types including fibroblasts and endothelial cells. It has anti-proliferative activity and potentiates the effect of interferons α and β (Vilcek et al 1985; Farrar and Schrieber 1993).

In the human endometrium IFN γ induces HLA-DR expression and inhibits proliferation of epithelial cells (Tabibzadeh et al 1988). This evidence supports the concept of the paracrine effect of IFN γ in the human endometrium.

IFN γ expression has been localised by immunohistochemistry to the glandular epithelial and stromal cells of the human endometrium during the secretory phase of the menstrual cycle (Chiang and Hill 1997). Yeaman and colleagues (1998) have shown that IFN γ is produced by polymorphonuclear neutrophils in the human endometrium.

IFN γ increases the production of the cytokines IL-6, monocyte chemoattractant protein-1 (MCP-1) and macrophage colony-stimulating factor (M-CSF) in human endometrial stromal cells *in vitro* (Nasu et al 1998).

The cytokines leukaemia inhibitory factor (LIF), interleukin 6 (IL-6), tumour necrosis factor α (TNF α), hepatocyte growth factor (HGF) and interferon γ (IFN γ) were measured in the conditioned media from both proliferative and secretory endometrial cells. Endometrial cell expression and production of cytokines LIF, IL-6 and TNF α have been extensively studied (see above) and are similar to PP14 and IGFBP-1 in that they are good markers of epithelial and stromal cell function. While less has been published about the role and function of the cytokines HGF and IFN γ in the human endometrium, these were also measured in the conditioned media from proliferative and secretory phase endometrial cultured cells.

4.2 Methods

All the following cytokines were assayed in media removed from the culture flasks containing endometrial cells at the time of passaging. The culture of endometrial cells is described previously in Section 3.2.2.

4.2.1 Cytokine enzyme immunoassays

All the kits used monoclonal antibodies. The basic protocol was the same for all the cytokines measured and was briefly as follows. To a well of a microtitre plate, 100 μ l of standard or sample was added and incubated for 20 mins at 37°C. The contents of the plate were discarded and the wells were washed extensively using an automated plate washer. Then 100 μ l of biotin anti-cytokine conjugate was added to each well

and incubated as before. After discarding the contents of the wells and washing as before 100µl of streptavidin-HRP conjugate was added and incubated as above. Finally, the wells were incubated with a 1:1 mixture of phosphate-citrate buffer with peroxide and tetramethylbenzidine (TMB) and the absorbance of each well at 450 nm was determined using a plate reader.

The minimum detectable concentrations of LIF, IFN γ , TNF α , IL6, and HGF were 10 pg/ml, 17.5 IU/ml, 20 pg/ml, 5 pg/ml and 0.25 ng/ml respectively.

The intra- and interassay coefficients of variation of both the protein and cytokine assays were less than 10%.

4.3 Statistical analysis

Levels of cytokines from proliferative and secretory endometrium were not normally distributed (Kolmogorov-Smirnoff test $p < 0.05$) and therefore it was necessary to compare the groups using the Wilcoxon Mann Whitney U-test.

In all cases, differences between the groups were considered significant when the probability of the events occurring by chance was < 0.05 .

4.4 Results

4.4.1 LIF

Figure 4.1 show levels of LIF throughout culture in both proliferative and secretory phase cell supernatants from individual tissues. Levels were significantly higher in the media from secretory phase cells than those from the proliferative phase throughout culture except for the period 16-20 days (see Table 4.1).

4.4.2 IL-6

Measurable levels of IL-6 were found in conditioned media from both proliferative and secretory phase cultured cells. Figure 4.2 shows IL-6 levels throughout culture from individual tissue taken from either the proliferative or secretory phase of the cycle. IL-6 levels steadily increase with time in medium from secretory phase cells reaching a plateau by day 16 in culture. Although proliferative phase cell production of IL-6 is lower than that produced by secretory phase cells, levels only become significantly different from day 21 of culture onwards (see Table 4.1).

4.4.3 HGF

Measurable levels of HGF were found in the conditioned media from both proliferative and secretory phase cultured cells. Figure 4.3 show levels throughout culture from individual tissue taken from either the proliferative or secretory phase of the cycle. However, at no period during culture was there a significant difference between secretory and proliferative phase cell HGF production (Table 4.1).

4.4.4 TNF α and IFN γ

Levels of TNF α and IFN γ produced by secretory and proliferative cells in culture were both negligible throughout the entire culture period, being below the limits of detection of the assays (20 pg/ml and 17.5 IU/ml respectively).

Table 4.1 *In vitro* concentrations of cytokines LIF, IL-6 and HGF (total mass in ng) produced by primary endometrial cells taken from the proliferative and secretory phases of the menstrual cycle.

		Proliferative phase	secretory phase	
Cytokine	days from seeding (n)	Median (range)(ng)	median (range)(ng)	p value
LIF	0 – 5 (5)	2.5 (0.3 – 3.9)	8.9 (3.3 – 55.3)	0.016
	6 – 10 (5)	1.7 (0.3 - 3.8)	11.5 (8.8 - 39.4)	0.014
	11 – 15 (4)	1.7 (0.45 – 3.5)	10.3 (7.6 - 13.6)	0.020
	16 – 20 (4)	1.3 (0.1 – 2.5)	2.6 (2.2 - 4.7)	0.110
	21 – 25 (4)	0.7 (0.2 – 0.7)	2.6 (1.4 - 4.0)	0.034
	26 – 30 (4)	0.4 (0.2 – 0.8)	2.9 (1.3 - 4.4)	0.034
	IL-6	0 – 5 (5)	36.9 (4.4 – 142.5)	81.0 (16.7-277.8)
6 – 10 (5)		33.9 (4.4 – 87.0)	151.6 (59.3-234.3)	0.090
11 - 15 (4)		31.3 (4.1 – 56.3)	144.7 (60.8-357.2)	0.083
16 – 20 (4)		31.2 (11.0 – 267.0)	281.3 (72.9-321.4)	0.160
21 – 25 (4)		17.0 (12.0 – 41.0)	283.0 (76.2-339.0)	0.034
26 – 30 (4)		28.0 (13.0 – 55.0)	254.0 (76.0-358.0)	0.034
HGF		0 – 5 (5)	1.1 (0.7 – 1.8)	3.1 (0.9 - 25.6)
	6 – 10 (5)	1.0 (0.8 – 5.9)	3.8 (0.9 - 6.0)	0.210
	11 - 15 (4)	1.7 (0.7 – 3.1)	3.3 (2.8 - 5.9)	0.140
	16 – 20 (4)	2.8 (1.4 – 4.2)	1.7 (1.3 - 1.9)	0.290
	21 – 25 (4)	1.4 (1.4 – 3.0)	1.3 (0.5 - 2.8)	0.290
	26 – 30 (4)	1.6 (1.5 – 2.0)	1.6 (0.6 - 3.0)	0.860

Figure 4.1 *In vitro* concentrations of cytokines LIF (total mass in ng) produced by primary endometrial cells taken from the proliferative and secretory phases of the menstrual cycle. Error bars represent maximum and minimum values. * significant difference between proliferative and secretory phases ($p < 0.05$).

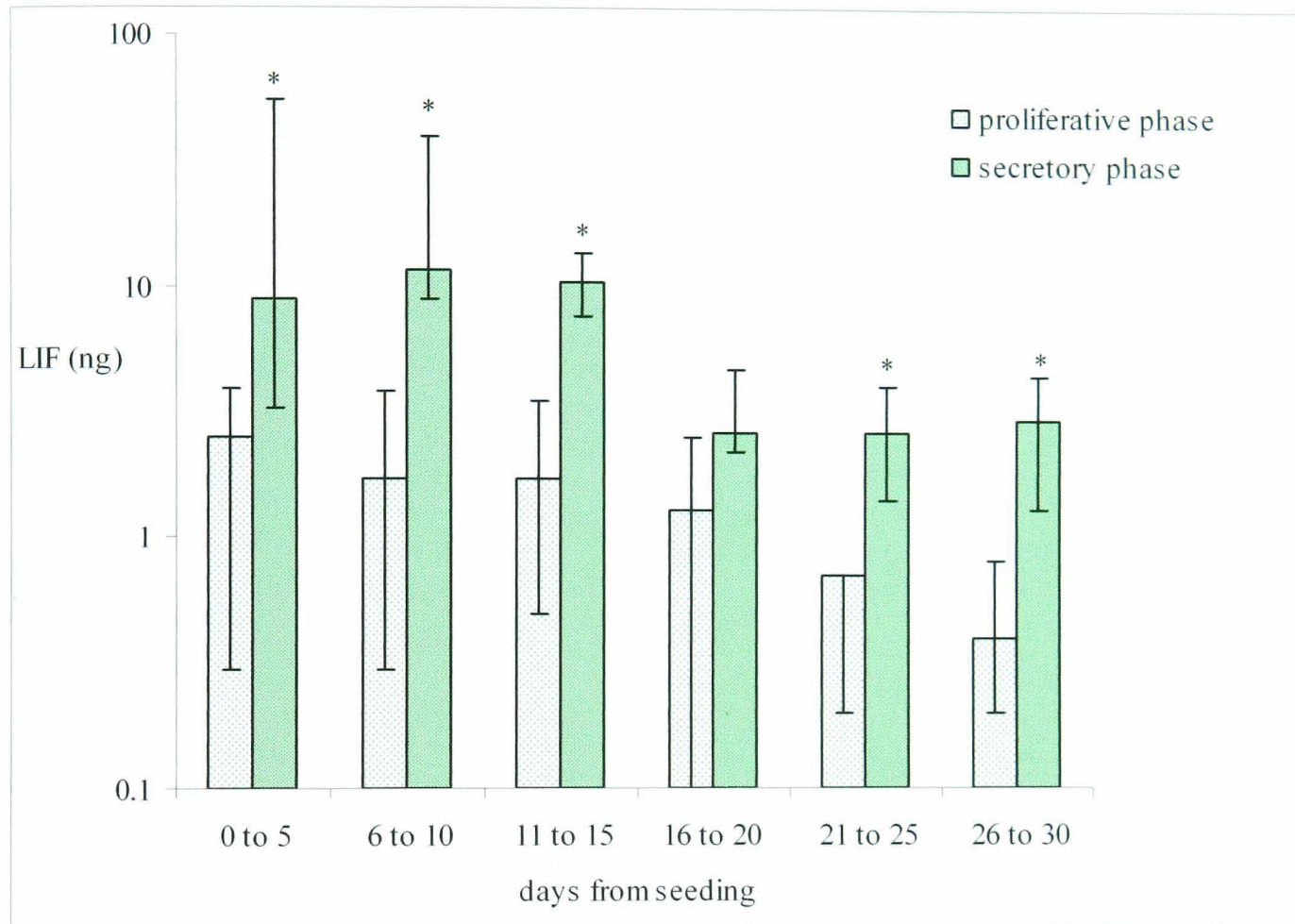

Figure 4.2 *In vitro* concentrations of cytokines IL-6 (total mass in ng) produced by primary endometrial cells taken from the proliferative and secretory phases of the menstrual cycle. Error bars represent maximum and minimum values. * significant difference between proliferative and secretory phases ($p < 0.05$).

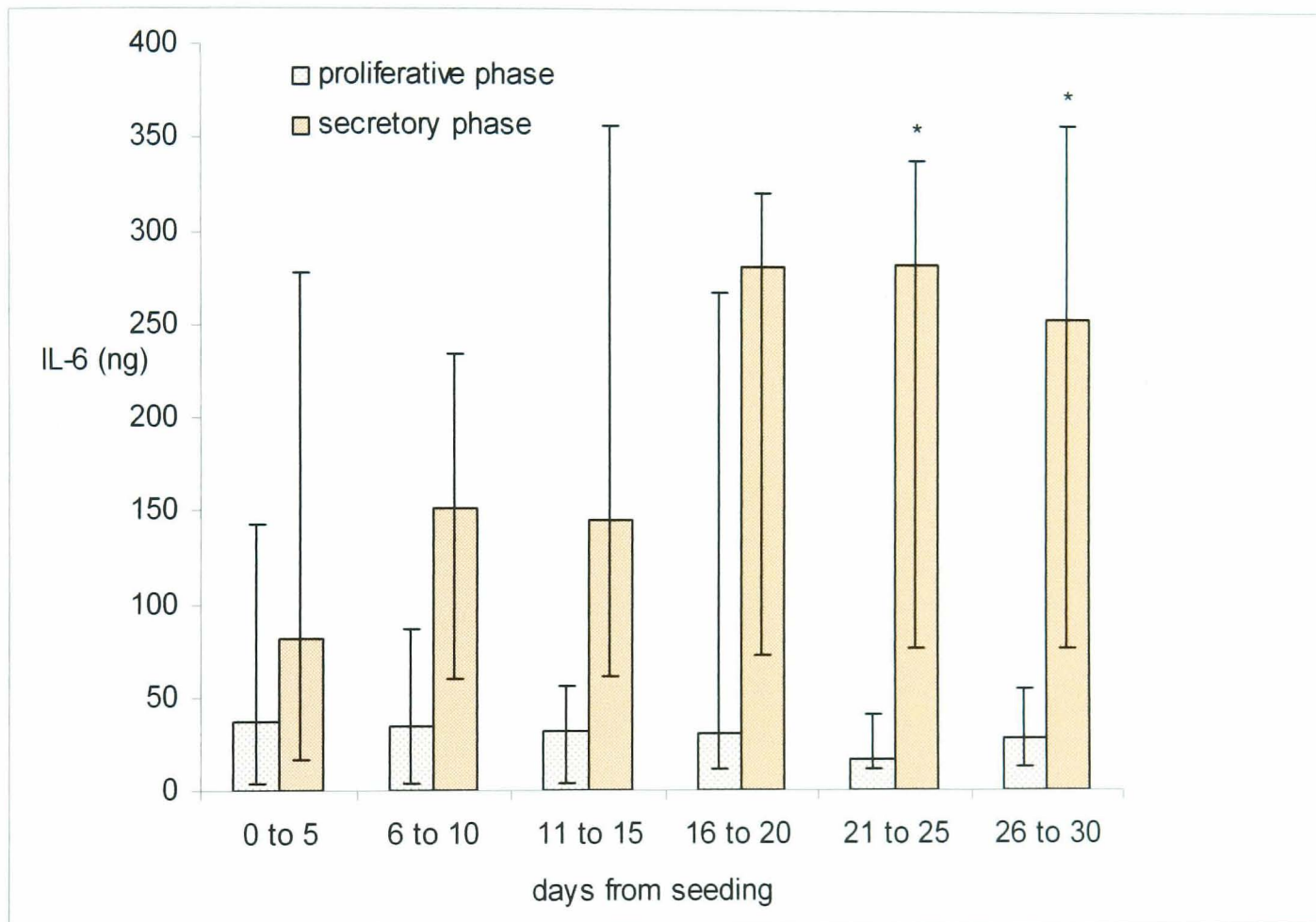
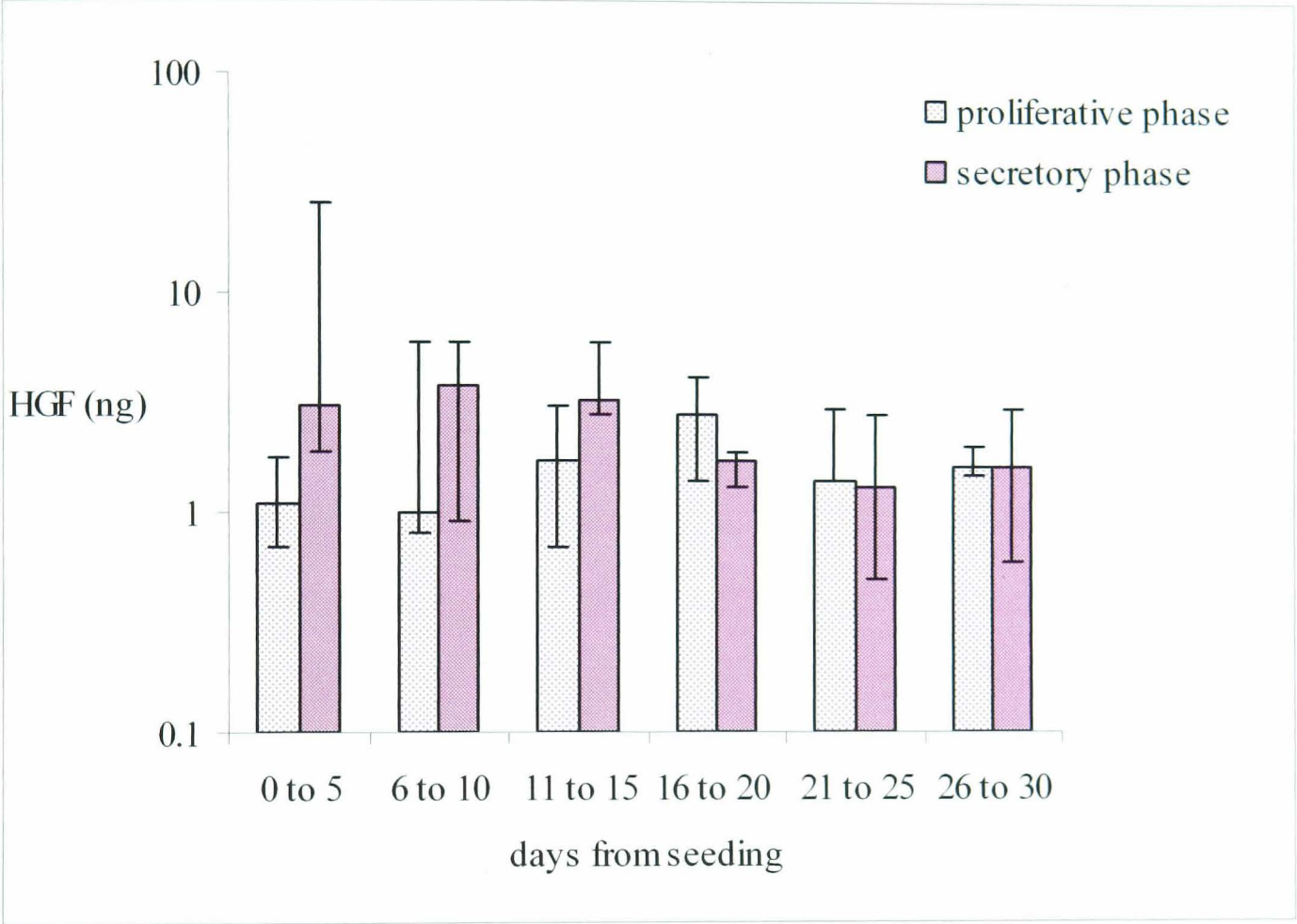

Figure 4.3 *In vitro* concentrations of cytokines HGF (total mass in ng) produced by primary endometrial cells taken from the proliferative and secretory phases of the menstrual cycle. Error bars represent maximum and minimum values. Not significant at any time point.



4.5 Discussion

The production of LIF by the endometrial cell culture in this study follows that found by other workers (Chen et al 1995; Laird et al 1997). The production of LIF is significantly higher by those cells cultured from the secretory phase than those cultured from the proliferative phase.

IL-6 was produced by cultured cells from both proliferative and secretory phase tissue. There is a greater production of IL-6 by secretory phase cells than that of proliferative phase cells although this difference is not significant until day 21 onwards of culture. IL-6 has been demonstrated in normal endometrium throughout the menstrual cycle and can be produced by both stromal and epithelial cells (Tabibzadeh et al 1989; Laird et al 1993). Tabibzadeh et al (1989) showed that IL-6 production by stromal cells is down regulated by physiological concentrations of oestradiol. However, there appears to be no reduction of IL-6 production by the cultured cells, if anything, there is a small increase from day 21 onwards in the secretory phase cell culture. Human endometrial stromal cells can be induced by a number of inflammatory-associated cytokines (IL-1 α , IL-1 β , TNF α and IFN γ) (Tabibzadeh et al 1989) to secrete IL-6 but TNF α and IFN γ cannot be detected in the conditioned media from the cell culture so this would not be a possible explanation for the apparent increase of IL-6 in the secretory phase cell culture.

Negami et al (1995) measured serum levels of HGF throughout the menstrual cycle and found that HGF increased throughout the luteal phase and reached a peak during the menstrual phase followed by a decline throughout the follicular phase. Groups studying the production of HGF by endometrial cells in culture did so using tissue taken from the proliferative phase only and found that production is confined to

stromal cells (Sugawara et al 1997; Fukaya et al 1999). However, Nasu et al (1999) found that levels of HGF in conditioned media were undetectable in their assay. No group to date has looked at the secretion of HGF by stromal cells from the secretory phase of the cycle. In this study HGF was detected in the conditioned supernatant from proliferative and secretory phase cell culture. The difference in production is not significant although the secretory phase levels are generally higher than those of the proliferative phase.

Reports of TNF α production by the endometrium are inconsistent. TNF α has been shown by various methods, including mRNA expression, immunohistochemistry and quantitative assays to be present in the endometrium throughout the menstrual cycle with low levels in the proliferative phase and higher in the secretory phase (von Wolff et al 1999). Laird et al (1996) found that stromal cells did not produce TNF α at any stage of the menstrual cycle whilst Bergqvist et al (2000) found TNF α was detected in medium from most stromal cell cultures but less often in the media from epithelial cell culture. In this study TNF α was not detected in the supernatants from any of the cultures. The measurement of TNF α is fraught with difficulties (Coxon 1996). Most methods of detection rely upon the use of an antibody and, for TNF α , monoclonal and polyclonal antibodies are available. TNF α exists as a monomer but associates readily to form relatively stable trimers which are more biologically active and possess a higher binding capacity for an antibody. A monoclonal antibody, which is highly specific, will be directed against a single epitope and is unable to form a large antigen-antibody complex whereas a polyclonal antibody can be used for macromolecules with multiple epitopes, of which TNF α is an example (Coxon 1996). The kit used in this study uses a monoclonal antibody and all other reported assays

use a polyclonal antibody. The difference between assay systems may be explained by the use of these antibodies. During the formation of a multimeric isoform of the TNF α molecule the epitope to which the monoclonal antibody has been developed may be hidden thus preventing binding whereas a polyclonal antibody would be more likely to bind to more than one epitope. In summary, the TNF α molecule may be biologically inactive owing to unfolding, protease action or physical effects, such as temperature and pH, yet may preserve the immunoreactive epitope and therefore read 'positive' in the immunoassay.

IFN γ has been shown to be localised to T-cell containing lymphoid aggregates and other cells in the stroma of the basalis region of the human endometrium (Tabibzadeh 1994). Chiang and Hill (1997) found IFN γ in both epithelial and stromal cells of the secretory phase endometrium with staining being more intense in the basalis layer. A group using confocal microscopy (Yeaman et al 1998) found IFN γ in stromal cells and intraepithelial lymphocytes through all stages of the menstrual cycle. The stromal cells containing intracellular IFN γ were later identified as polymorphonuclear neutrophils which on stimulation by certain ligands, for example, TNF α , produced IFN γ (Yeaman et al 1998).

To date no data has been published on the secretion of IFN γ by endometrial cells *in vitro*. This study found that IFN γ levels were undetectable in the conditioned media from a mixed endometrial cell population. It is possible that this lack of IFN γ may be due to the absence of suitable stimuli, for example TNF α .

CHAPTER 5

ENDOMETRIAL CELL RESPONSE TO IFN α

5.1 Introduction

Type I interferon signalling is mediated via a cytokine type II receptor. Cytokine receptors are transmembrane proteins with a single membrane-spanning region and are divided into two classes depending on their amino acid sequence and structural features. The majority of cytokine receptors fall into class I whilst the IFN α , β and γ , IL-10 and tissue factor receptor belong to class II.

Early investigations revealed cell surface expression of both low and high affinity receptors for type I interferons (Branca and Baglioni 1981; Aguet 1980). Binding and cross-linking studies using radiolabelled IFNs suggested that the putative receptor had a multi-subunit structure (Joshi et al 1982). The existence of this multi-subunit structure was later demonstrated using specific monoclonal antibodies to the receptor subunits (Colamonici et al 1990; Colamonici et al 1992).

The first receptor subunit to be cloned was the IFN α R (Uze et al 1990). This is a 557 amino acid glycoprotein which does not bind most IFN α subtypes nor IFN β with high affinity but is required for signal transduction (Uze et al 1990). The extracellular region of the IFN α R is composed of two domains of about 200 amino acids (D200) each of which can be further subdivided into two homologous SD100 domains (figure 5.1).

Subsequently the second receptor subunit was isolated. This was a 331 amino acid glycoprotein designated IFN α / β R which binds and responds to IFN β and most of the IFN α subtypes (Novick et al 1994). The extracellular region of the IFN α / β R contains just two SD100 domains (figure 5.1).

Figure 5.1 The Type I interferons bind to the same receptor which comprises of two transmembrane subunits that are classified as Type II cytokine receptors. The IFN α BR sub-unit, also known as IFNAR-1, has an extracellular region composed of two homologous regions of about 200 amino acids each of which contain two fibronectin type III domains. The IFN α/β R sub-unit, also known as IFNAR-2, comprises of two FNIII domains. From Callard and Gearing (1994).

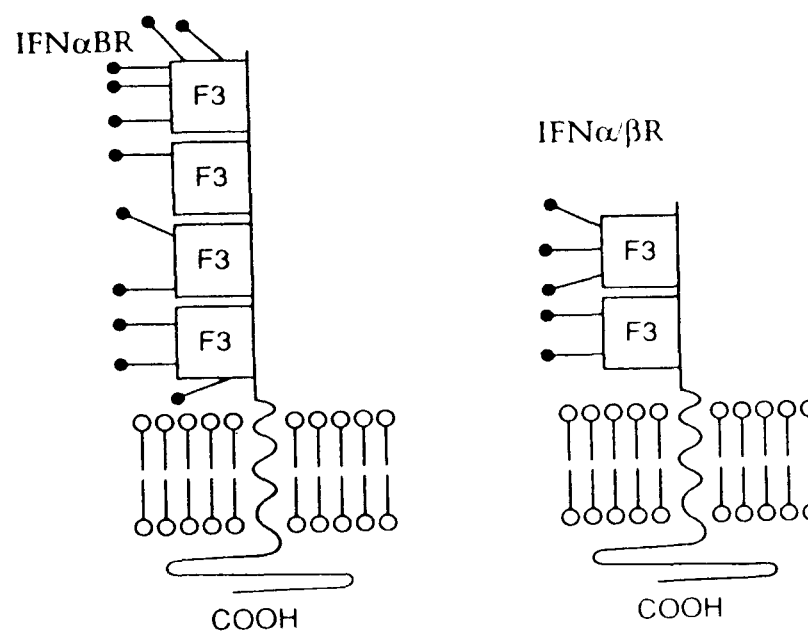

Unlike growth factor receptors, cytokine receptors do not possess any intrinsic tyrosine kinase activity directly. However, the IFN α R and the IFN α/β R constitutively associate with the Janus kinases, Tyk2 and JAK1 respectively, which provide the tyrosine kinase activity necessary for receptor activation (Darnell et al 1994; Stark et al 1998). IFN α R, IFN α/β R, Tyk2 and JAK1 are known to form the functional type I IFN receptor complex (Darnell et al 1994; Stark et al 1998).

A soluble form of the receptor has been identified in human serum and urine (Novick et al 1992) and is a potent blocker of all Type I IFNs and it is thought to function as a modulator of IFN activity *in vivo*.

Subunits of the receptor are expressed in all tissues (Haque and Williams 2001) however the pattern of expression in human endometrial tissue has not been fully elucidated. Lee and colleagues (1998) assessed the effects of IFN α on primary cultures of leiomyoma, myometrial and endometrial stromal cells and found that it was a potent inhibitor of proliferation for endometrial stromal cells.

The aim of this study was to elucidate the signal transduction mechanisms of Type I interferons in human primary endometrial cells. Type I interferons are known to elicit an effect in mammalian endometrium (see Chapter 1 Introduction), yet it was important to establish that primary human endometrial cells maintained *in vitro* possess a functioning receptor, as this would be the model system used.

Therefore, it was necessary to conduct an experiment to confirm the presence of a functioning IFN α/β receptor on cultured endometrial cells.

Inhibition of endometrial cell proliferation by IFN α would provide evidence for the presence of a Type I interferon receptor.

All IFNs demonstrate antiproliferative effects on many cell types grown *in vitro* (Pfeffer et al 1987). In the presence of IFN there is an increase in the time taken for completion of the cell cycle but it remains unclear which, of several mechanisms, are involved.

In this study, human endometrial cells were cultured in the presence of increasing concentrations of human IFN α . The effect of IFN α on cell proliferation would provide evidence for a functioning receptor but would not localise it to a particular cell or cells. To do this immunohistochemistry was carried out (Chapter 6).

5.2 Methods

Endometrial tissue was seeded out and grown to confluence in a 75 cm² flask. At this point the cells were trypsinised and passaged on equally into 5 x 25 cm² flasks. Ten ml of supplemented DMEM:Ham's F12 medium, with or without IFN α , was added to each flask. The concentration of IFN α added was 100, 1000, 10,000 and 50,000 units per ml of medium. The flask containing medium without added IFN α served as the control.

After 4 days growth the cells were assessed for viability using the Trypan blue exclusion method as described in section 3.2.4 before undergoing Giemsa staining.

For this process the cells were washed twice with PBS followed by PBS and increasing concentrations of methanol until a 50% methanol/PBS solution was reached. This mixture was discarded and replaced with methanol alone. After 10 min the methanol was removed and 2ml of undiluted Giemsa was added to the flask. The stain was diluted with 8ml of water after 2 min and after a further 2 min was discarded. The cells were extensively washed in running tap water and finally

examined and photographed while still wet. Once stained, the cells could be stored dry and wetted for re-examination.

To assess the reduction in proliferation of endometrial cells in response to IFN α the number of cells seen in 4 different fields of view at x 400 magnification was recorded for each concentration of IFN α . From this data a mean cell count could be calculated for each IFN concentration.

5.3 Results

Primary human endometrial cells are capable of responding to IFN α since cell proliferation is clearly suppressed in the presence of 100 units and 50,000 units of IFN α per ml of media (Figure 5.2). The Trypan blue exclusion method showed that approximately 10 cells per 10,000 cells had taken up the dye. Therefore about 0.1% of cells were non-viable.

Table 5.1 shows the number of cells counted in the field of view at x 400 magnification for each concentration of IFN α used.

Figure 5.2 Primary human endometrial cells cultured in the absence of IFN α (A) or in the presence of 100 units/ml (B) or 50,000 units/ml IFN α (C). Magnification x 100.

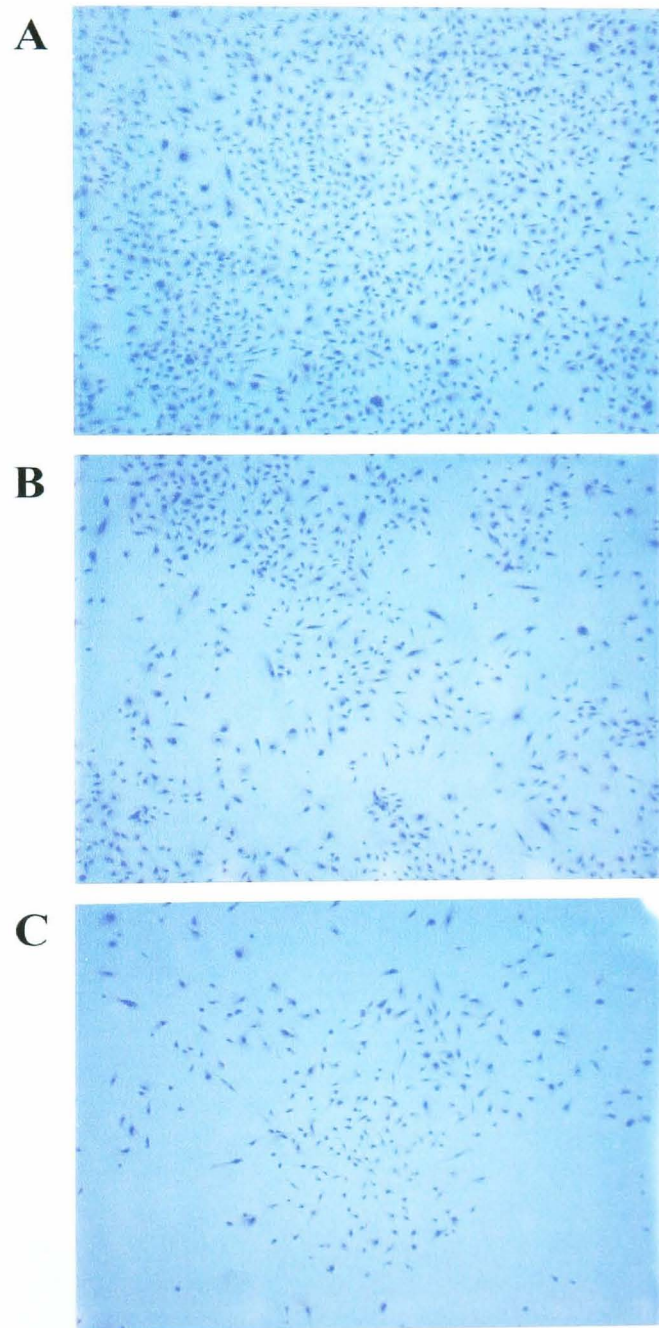
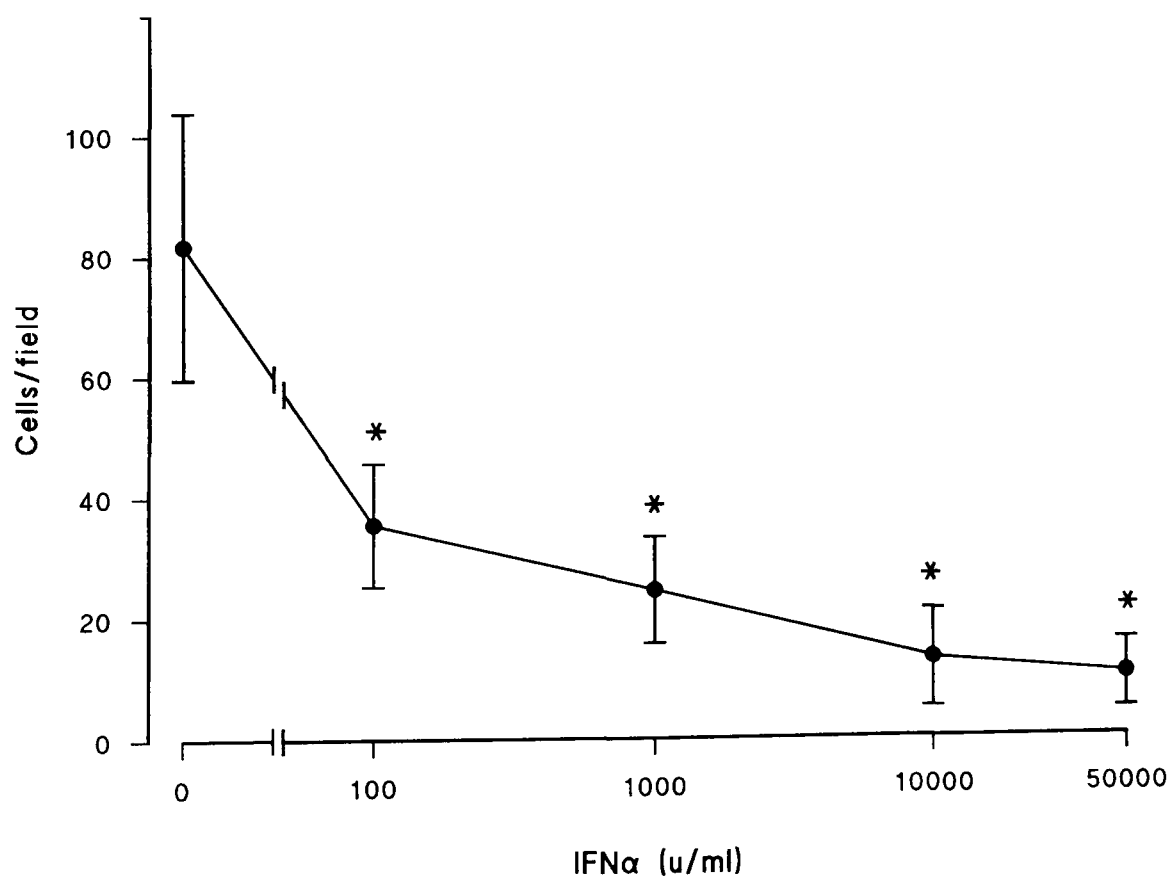

Table 5.1 Number of endometrial cells seen in a x 400 magnification field of view having been cultured in the presence of increasing concentrations of IFN α

IFN α (u/ml)	1 st count	2 nd count	3 rd count	4 th count	mean cell count (+/- SD)
0	91	53	78	105	81.75 +/- 22.1
100	45	38	21	38	35.5 +/- 10.2
1000	35	28	15	20	24.5 +/- 8.8
10 000	10	21	3	18	13 +/- 8.1
50 000	5	6	17	13	10.25 +/- 5.7

Figure 5.3 Effect of IFN α concentration on cell number. * indicates $p < 0.01$ vs control cells without addition of IFN α .



5.4 Discussion

The results provide direct evidence for the presence of an IFN receptor on endometrial cells because the primary endometrial cells in culture respond to IFN α . Endometrial cell proliferation was suppressed in the presence of 100 units and 50,000 units of IFN α per millilitre of culture medium. Type I interferons have demonstrable antiproliferative effects on many cells and cell lines grown *in vitro* (Pfeffer et al 1987). IFN α has been shown to be a potent inhibitor of human endometrial stromal cell proliferation (Lee et al 1998).

In this study, stromal and epithelial endometrial cells from both the proliferative and secretory phases of the menstrual cycle showed an anti-proliferative response on exposure to IFN α , providing evidence for a functioning IFN α/β receptor on these cultured cells. These results confirm the findings of Lee et al (1998) that IFN α is a potent inhibitor of endometrial stromal cell proliferation and, in addition, this study has shown that IFN α also inhibits the proliferation of epithelial endometrial cells *in vitro*. The antiproliferative effect seen in these cells must be considered to be due to the cells responding to IFN α and not to any cytotoxic effect the IFN α may have conferred as only a negligible number of cells (<0.1%) were found to be non-viable by the Trypan blue exclusion method.

Since human endometrial cells *in vitro* respond to IFN α , one can deduce that they must possess a receptor through which this response is mediated.

Nevertheless, the fact that the cells clearly respond to IFN α indicates that primary human endometrial cells of both cell lineages possess a functioning receptor.

CHAPTER 6

LOCALISATION OF A TYPE I INTERFERON RECEPTOR ON ENDOMETRIAL CELLS

6.1 Introduction

To date, there have been relatively few studies on Type I IFN receptor expression in the human endometrium. The effect of IFN α on cell proliferation provides evidence for a functioning receptor in these cells (Chapter 5) but does not localise receptor expression to a particular cell or cells. To do this immunohistochemistry was carried out on proliferative and secretory endometrial tissue.

For the purposes of this thesis, it is essential to determine whether such expression is maintained in long term culture of isolated cells. As far as we are aware, there are no reports on the localisation of the Type I IFN receptor on primary human endometrial cells in culture. Thus, in this chapter we also investigate the presence of functioning Type I IFN receptor in these cells following long-term culture.

6.1.1 Immunohistochemistry

Immunohistochemistry, using a monoclonal antibody (anti-IFN α/β R) raised against the 27-210 amino acids of the human IFN α/β receptor (IFNAR-2) and a polyclonal antibody (anti-IFN α R) raised against the 458-557 amino acids mapping the carboxy terminal end, the intracellular domain, of the human IFN α receptor (IFNAR-1), was performed on paraffin embedded and frozen sections of endometrial tissue taken from various stages of the menstrual cycle (see section 6.2.1). Immunohistochemistry on biopsied tissue localises the receptor to cells within that tissue but would not indicate the presence of a receptor on the cells grown for this study. To do this, it was necessary to carry out further experiments to try and locate a receptor on cultured cells using radiolabelled ligand binding and electron microscopy using a gold conjugated second antibody.

6.1.2 Binding of ¹²⁵I-IFN α

Endometrial cells were cultured in media supplemented with labelled IFN α and then visualised according to the methods explained in section 6.2.2.

6.1.3 Electron microscopy

Cells were cultured in small mesh-bottomed inserts as described in section 6.2.3 and then incubated firstly with the monoclonal IFN α / β R first antibody and then with the mouse second antibody conjugated to gold before being fixed, embedded and prepared for electron microscopy (see section 6.2.3).

6.2 Methods

6.2.1 Immunohistochemistry

Paraffin embedded and frozen slides of endometrial tissue from various stages of the menstrual cycle were prepared by the Department of Histopathology, St Bartholomew's Hospital, London. These slides underwent immunoperoxidase staining using the monoclonal anti-IFN α / β receptor at 1:100 dilution and the polyclonal anti-IFN α receptor at a dilution of 1:50. The paraffin embedded slides were pre-treated by brief, high temperature, heat denaturation pressure cooking to increase antigen retrieval (Norton et al 1994).

Briefly, the slides were blocked for endogenous peroxidase activity using a 3% hydrogen peroxidase in methanol solution. Then washed and blocked for non-specific binding using 10% normal rabbit serum in 50 mM Tris-buffered saline. The blocking solution was replaced with the primary antibody of interest. After incubation the slides were washed and reagents from the ABC kit were applied according to the

manufacturer's protocol. Next diaminobenzidine (DAB) solution was added to the slides, washed off and counter-stained with haematoxylin. Finally, the slides were dehydrated, cleared, mounted, examined by microscopy and photographed.

6.2.2 ¹²⁵I-IFN α method

IFN α was labelled with ¹²⁵Iodine using a modification of the technique used by Greenwood et al (1963).

Into a vial was placed 5 μ g of IFN α in 5 μ l of 50mM PBS and 5 μ l of 250mM PBS. To this was added 500 μ Ci (5 μ l) of sodium ¹²⁵iodide followed by 12.5 μ g of chloramine T in 5 μ l 50mM PBS, pH 7.5. After mixing for 15s the reaction was stopped by the addition of 31.25 μ g of sodium metabisulphite in 5 μ l of 50mM PBS. The contents of the vial were mixed thoroughly and 75 μ l of 50mM PBS containing 0.1% BSA was added before applying the contents to a 1 x 60 cm column of Sephadex G-100 previously equilibrated with 50mM PBS/0.1% BSA, pH 7.5 to separate ¹²⁵I-IFN α from damaged materials or unreacted sodium ¹²⁵iodide. Appropriate fractions were assessed for immunoreactivity by binding in the presence and absence of IFN α antibody at an initial dilution of 1:100. Fractions showing greatest binding were pooled, aliquoted and stored at -20°C.

Endometrial tissue was grown to confluence and then trypsinised. The resulting cell suspension was divided equally into the 8 chambers of two Nunc chamber slides. As an enclosed system for incubating cells was being employed the chamber slides had to be incubated in an enclosed unit containing 95% air and 5% carbon dioxide. This was achieved by using a small, sterilised dessicator with a tap which allowed the gas to be introduced. After 5 days the medium was discarded and the cells washed x 3 with

sterile PBS. Then ^{125}I -IFN α , diluted in PBS to give 10,000 counts in 100 μl , was added to the chambers of one slide and as a control iodinated anti-digoxin, diluted to give the same counts as the ^{125}I -IFN α , was added to another. Anti-digoxin was used as a control because many radiolabelled ligands available would bind to their specific receptors whilst anti-digoxin would only bind to the drug digoxin. Both slides were then incubated for 1 hr at 37 °C. The radioactive material was then discarded and the slides washed extensively with PBS and the cells fixed using increasing concentrations of methanol until 100% methanol is reached. The dried slides were exposed to x-ray film using an intensifying screen for 5 days at -20°C and then visualised.

6.2.3 Electron microscopy

On the recommendation of the Department of Photomicrography, St Bartholomew's Hospital, London, who carried out the fixing, embedding and electron microscopy, the endometrial tissue was seeded out onto Falcon cell culture inserts with a 0.4 μm pore size membrane. Cells were grown in 5 inserts, one for control purposes and the other 4 for different dilutions of first antibody. After 5 days of growth the medium in the inserts was discarded and the cells were washed with PBS. The medium was replaced with either 200 μl of PBS containing 1% BSA for the control or monoclonal anti-IFN α/β receptor at an initial dilution of 1:50 1:100, 1:500 or 1:1000. The cells were incubated for 1 hr at room temperature. The first antibody was discarded and the cells washed with PBS/BSA prior to the addition of the second antibody - gold conjugate goat anti-mouse antibody. The cells were then incubated and washed as above and fixed in 200 μl of 1% paraformaldehyde with 0.1% gluteraldehyde in

0.125M phosphate buffer, pH 7.3. They were then embedded and examined by electron microscopy in the Department of Photomicrography. Alterations to the method included incubating at 37°C for 2 hours, using 400µl of first and second antibody and treating the insert membranes with poly-l-lysine to enhance adhesion.

6.3 Results

Localisation of the IFN α R and IFN α / β R.

6.3.1 Immunohistochemistry

Figures 6.1 and 6.2 show that antibodies to the IFN α R and IFN α / β R bind to the cells of endometrial tissue. Both IFN receptor subunits were expressed in stromal and glandular epithelial cells from both proliferative and secretory phases of the menstrual cycle. Expression of both receptor subunits was more intense in glandular epithelium compared with the surrounding stromal tissue.

A more intense staining of the IFNAR-1 receptor subunit was observed in the glandular epithelium of secretory compared to the proliferative phase tissue. IFNAR-2 expression was similar in secretory and proliferative tissue.

6.3.2 ¹²⁵I IFN α binding

The autoradiograph of endometrial cells labelled with ¹²⁵I IFN α (Figure 6.3a) shows a few cells have been radiolabelled. There was no radioactivity detected on the autoradiograph of the control experiment (Figure 6.3b).

6.3.3 Electron microscopy

No results were obtained using electron microscopy as a means of localising the Type I interferon receptor to endometrial cells in culture. The endometrial cells were grown on a mesh within an insert within the wells of an 8 well culture dish specifically for the purposes of electron microscopy. The cells did not adhere well and the mesh had to be treated with poly-l-lysine to enhance adhesion. Generally, endometrial cells grow as a monolayer and because of the small surface area of the mesh, the growth of a large number of endometrial cells was restricted. Although the adhesion of the cells was improved and they remained fixed to the mesh throughout the incubation with the first and second antibody once they went through the fixing and embedding process they became dislodged and were subsequently lost within the block of Araldite. Larger well sizes, and thus a greater mesh surface area, were used to raise the number of cells grown, however, this did not improve the recovery of cells once they had been embedded in Araldite. Finally, attempts to localise the receptor by this method were abandoned.

Figure 6.1 Immunostaining of endometrial tissue with polyclonal IFN α receptor antibody at 1 in 50 dilution. Magnification x 200.

proliferative phase

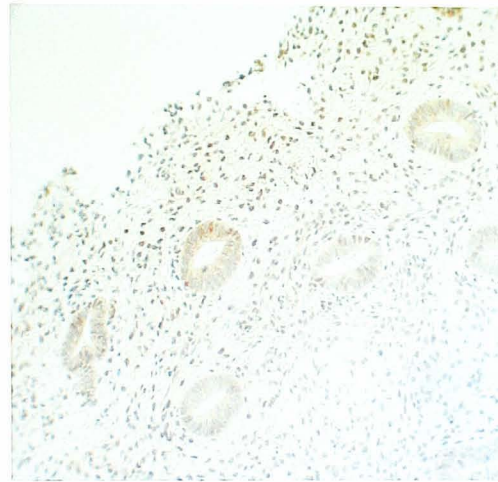

secretory phase

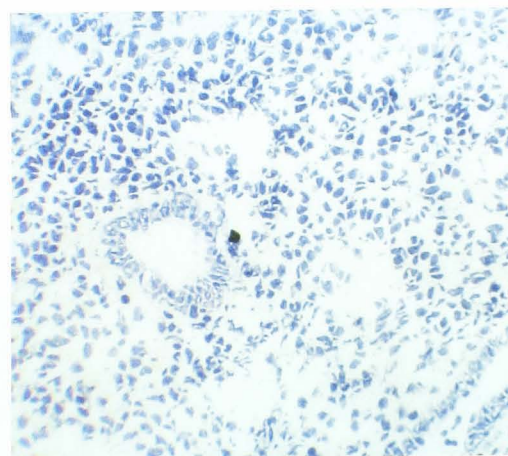
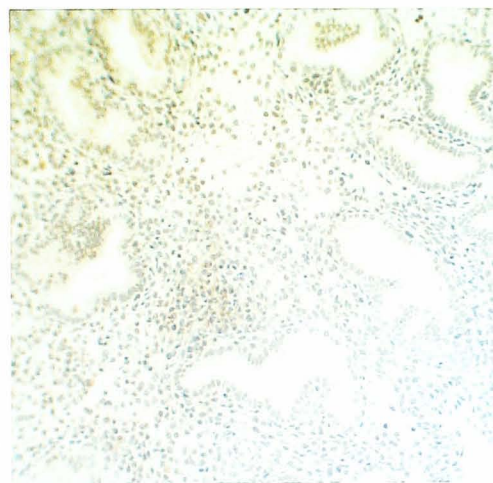

Figure 6.2 Immunostaining of endometrial tissue with monoclonal IFN α / β receptor antibody at 1 in 100 dilution. Magnification x 200.

proliferative phase



secretory phase

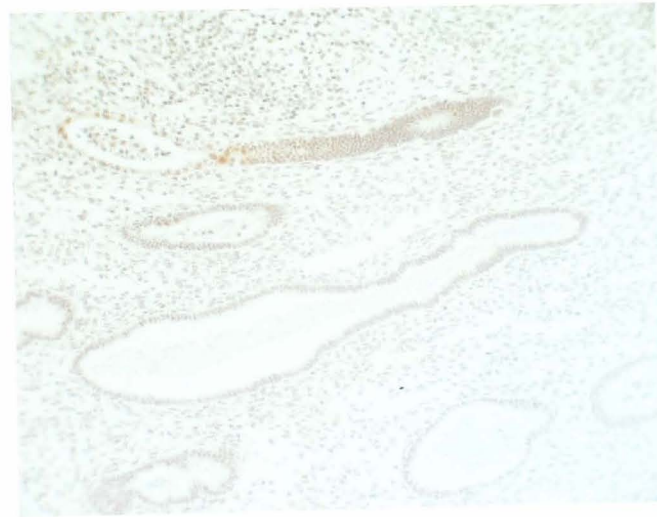
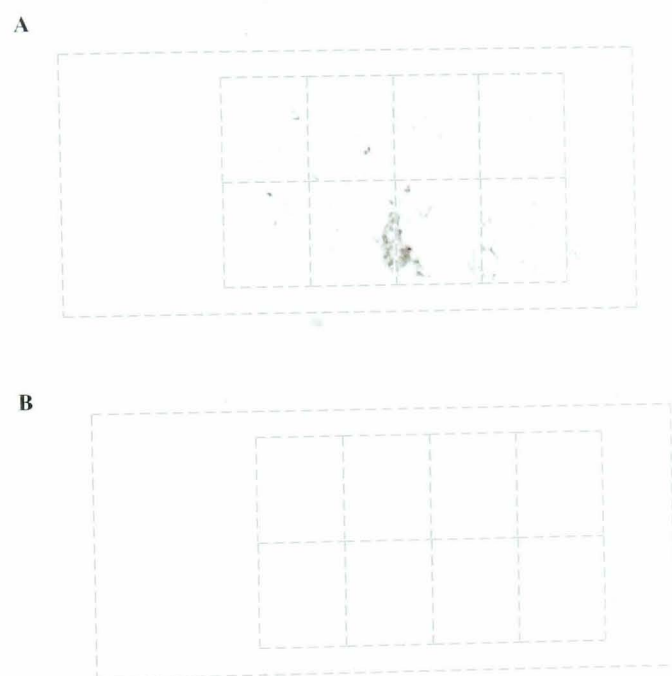

Figure 6.3 Autoradiograph showing cultured primary endometrial cells incubated with (A) ^{125}I IFN α and (B) ^{125}I anti-digoxin



6.4 Discussion

The results provide evidence for the presence of an IFN receptor on human endometrial cells. This is because (a) there was binding of radiolabelled IFN α to cells in culture and (b) there was binding of antibodies to both subunits of the IFN receptor (IFNAR-1 and IFNAR-2) on epithelial and stromal endometrial cells from tissues taken from the proliferative and secretory phases of the menstrual cycle.

Indirect evidence for the presence of a Type I IFN receptor on human endometrial cells in culture was demonstrated using ^{125}I -IFN α which showed some radioactive binding to the cells *in vitro*. However, this does not localise this receptor to a particular cell or cell types found in the endometrium. To do this, antibodies raised against the receptor subunits IFN α R (IFNAR-1) and IFN α / β R (IFNAR-2) were used in immunohistochemical staining of endometrial tissue sections taken from both the proliferative and secretory phases of the menstrual cycle. The immunohistochemistry, showed staining in both stromal and glandular epithelial cells in both proliferative and secretory tissue.

These results are in agreement with Ozaki et al (2005) who also found expression of both subunits in proliferative and secretory endometrial tissues.

Our results also confirm those of Russell and colleagues (1993) who found the radiolabelled IFN α bound to endometrial tissue.

CHAPTER 7

**PHOSPHOLIPID TURNOVER FOLLOWING
TYPE I INTERFERON STIMULATION**

7.1 Introduction

For a cell to generate a response it must be stimulated by an extracellular signal which interacts with a receptor to activate a set of second messengers which will elicit the response.

Since the discovery of cyclic adenine monophosphate (cAMP) and its mechanism of action, which provided the basis for the concept of second messengers, many other signal pathways have been discovered. The first indication that a lipid molecule could be involved in a signalling pathway came from the observations of Hokin and Hokin (1953). They reported that the administration of acetylcholine to pancreatic tissue increased the incorporation of radioactive phosphate groups (PO_4 groups containing ^{32}P) into phosphatidylinositol (PI) – one of the constituent lipids of the plasma membrane. Like other membrane lipids it has a hydrophobic constituent (two fatty acid chains attached to a glycerol molecule) and a hydrophilic constituent (the inositol phosphate ‘head’ group). The administration of acetylcholine caused the PI to cleave into its two major constituents – diacylglycerol and inositol phosphate while the observed increased incorporation of ^{32}P was due to the resynthesis of PI.

Subsequent studies established that increased turnover of membrane lipids occurred in response to many stimuli. In 1975 Michell and colleagues noted a strong correlation between stimulated lipid turnover and internal cell calcium signals and that it was another lipid, phosphatidylinositol-4,5-bisphosphate (PIP_2), whose hydrolysis was, in part, responsible for the increase in intracellular calcium. Phosphatidylinositol-4,5-bisphosphate (PIP_2) is converted from PI by the addition of two extra phosphate groups derived from adenine triphosphate (ATP) to the carbon 4 and carbon 5 positions on the six-carbon inositol ring (Figure 7.1). Further experiments (Haslam & Davidson 1984; Gomperts & Cockcroft 1985) found that guanosine triphosphate

Figure 7.1 The formation of PIP₂ from its precursor PI and its subsequent hydrolysis in response to an external stimulus with the formation of IP₃ and DAG, leading to an increase in intracellular Ca²⁺. PLC = Phospholipase C, P = Phosphate group, ^^^^^ = fatty acyl chains, ADP = adenine diphosphate, ATP = adenine triphosphate

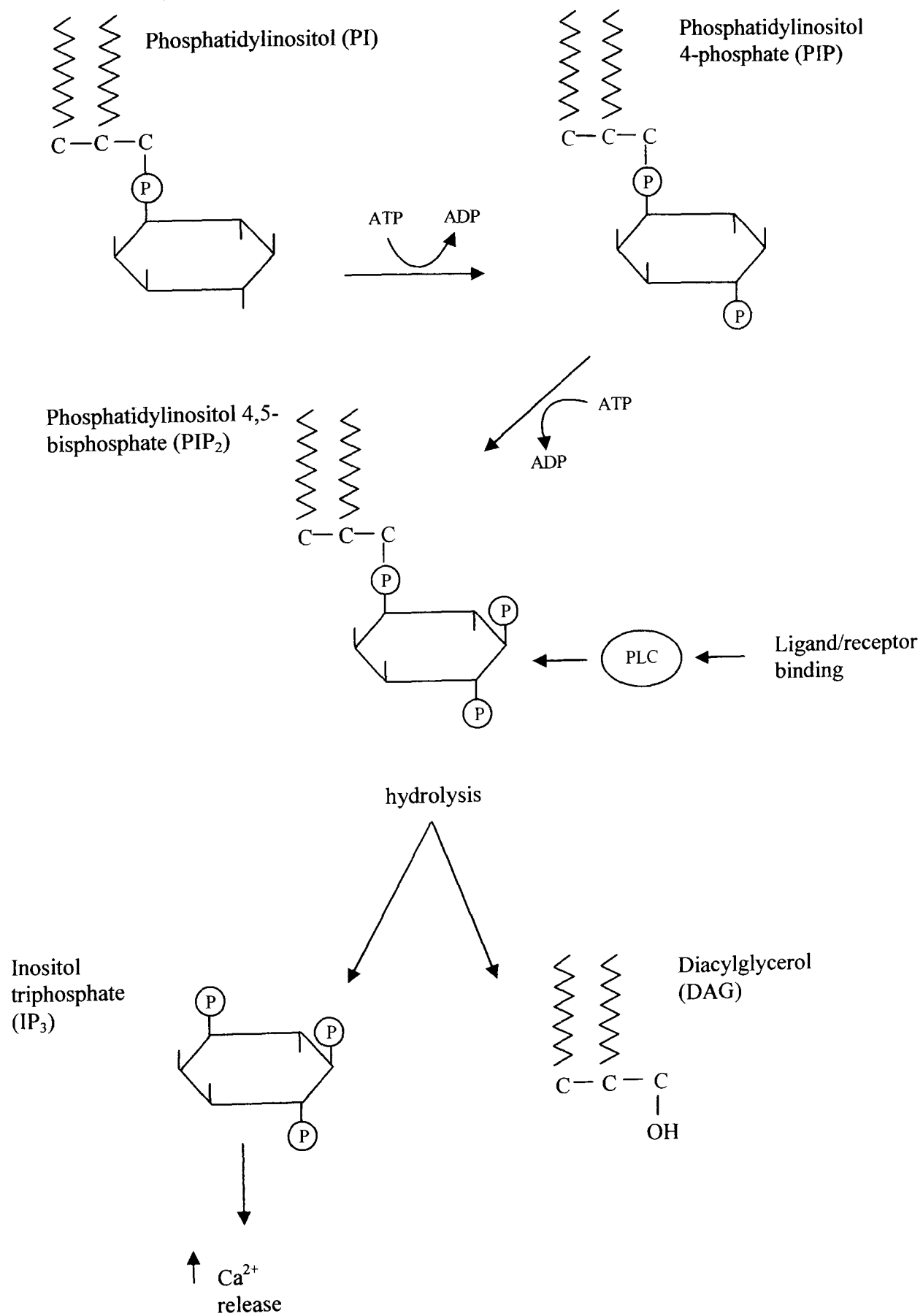

(GTP) is necessary for the IP₃ and DAG signalling mechanism. The G protein couples the surface receptor to the enzyme phospholipase C (PLC) which then cleaves the PIP₂ into IP₃ and DAG. IP₃, being water soluble, diffuses into the cytoplasm where it releases Ca²⁺ from storage in the endoplasmic reticulum. The role of IP₃ as a novel second messenger in cellular signal transduction was confirmed by experiments carried out by Berridge and Irvine (1984). The demonstration of Ca²⁺ release induced by IP₃ has since been shown in many cell types (Berridge 1991). IP₃ also elicits many of the early events of fertilisation and the injection of IP₃ into eggs can cause waves of Ca²⁺ to travel across the egg mimicking that seen by spermatozoa at fertilisation (Rice et al 2000).

The diacylglycerol formed from the hydrolysis of PIP₂ remains within the plasma membrane where it also acts as a second messenger by activating protein kinase C (PKC) which phosphorylates several proteins involved in cellular mechanisms, for example, cell growth. IP₃ and DAG are rapidly recycled to form PIP₂ and complete the inositol-lipid cycle (Figure 7.2).

However, the generation of second messengers as a result of phospholipid turnover is not restricted to PLC hydrolysis of PIP₂ (Figure 7.3). Indeed, activation of different membrane phospholipases which hydrolyse other phospholipids to generate second messengers are also responsible for a variety of cellular effects. For example, PLA₂ is known to act upon PC to release arachidonic acid (AA) which is converted by cyclooxygenases to prostaglandins and thromboxanes and by lipoxygenases to leukotrienes (Figure 7.3a). The sites of action of the phospholipases A₂, C and D are shown in Figure 7.4.

Figure 7.2 Inositol-lipid cycles replenish the supply of second messengers made from inositol lipids. An external signal acts through a PIP_2 phosphodiesterase, phospholipase C, which cleaves PIP_2 into DAG and IP_3 . These two messengers go through a series of chemical reactions which require ATP and CTP as sources of phosphate groups P_i to form PI and eventually reform PIP_2 . PDE = phosphodiesterase, CMP = cytosine monophosphate, CTP = cytosine triphosphate. From Rasmussen (1991).

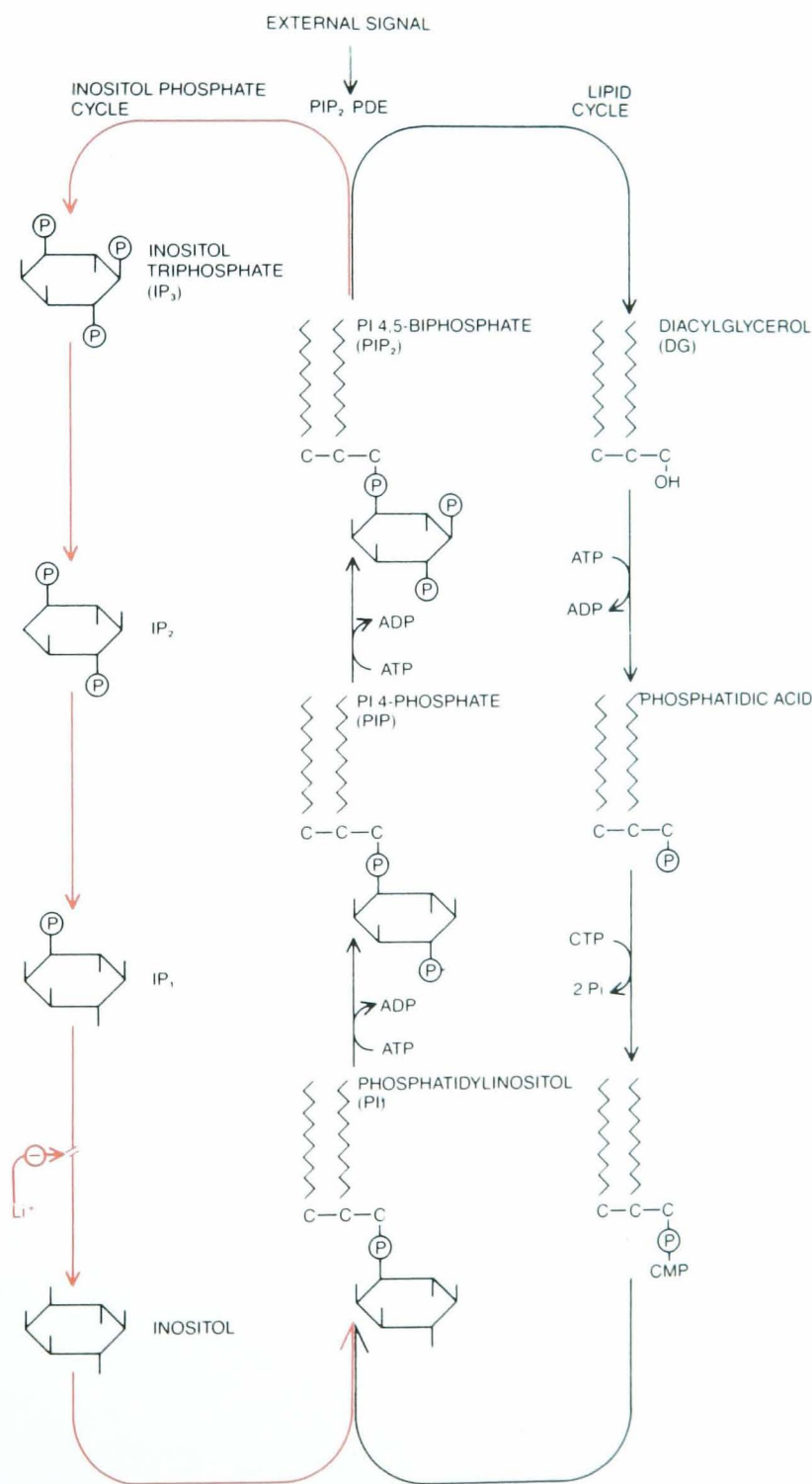
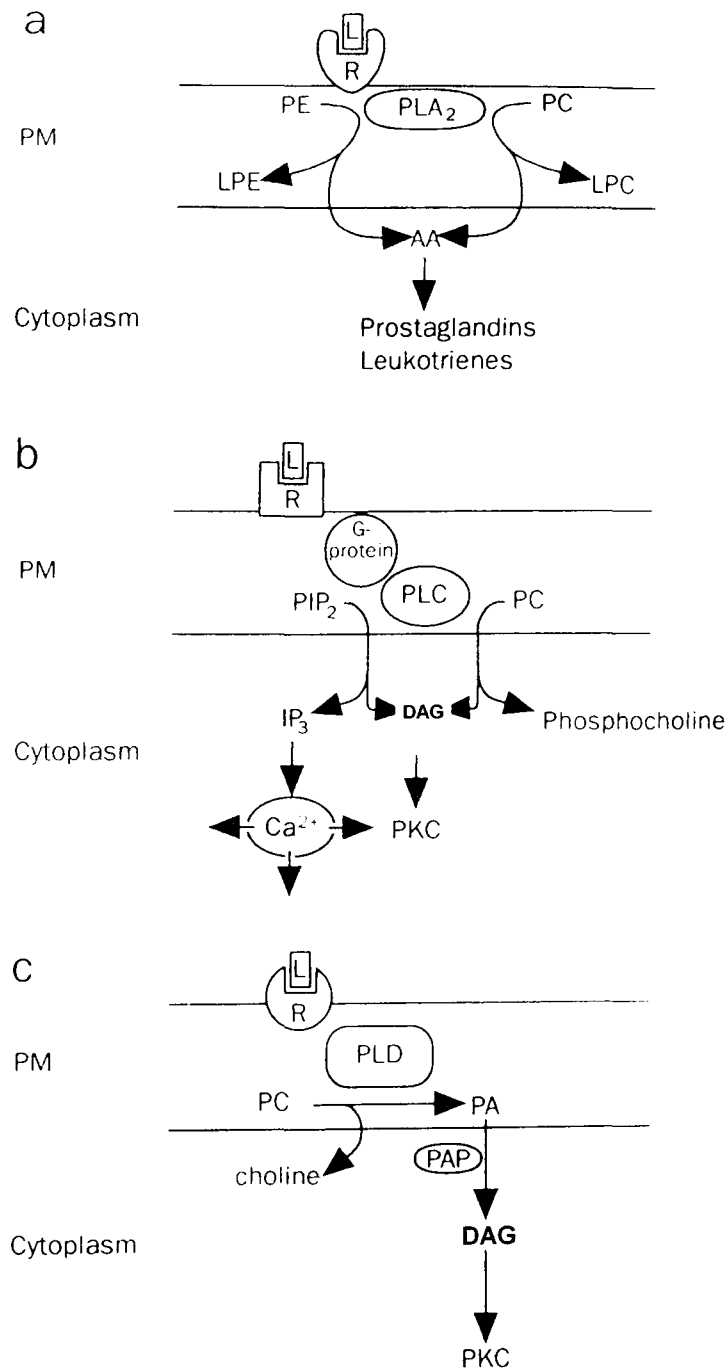

Figure 7.3 Transmembrane signalling mediated by phospholipid hydrolysis. (a) phospholipase A₂ (PLA₂); (b) phospholipase C (PLC); (c) phospholipase D (PLD). PM = plasma membrane; L = ligand; R = receptor; PE = phosphatidylethanolamine; LPE = lysophosphatidylethanolamine; PC = phosphatidylcholine; LPC = lysophosphatidylcholine; AA = arachidonic acid; PIP₂ = phosphatidylinositol 4,5-bisphosphate; IP₃ = inositol 1,4,5-trisphosphate; DG = diacylglycerol; PA = phosphatidic acid; PAP = PA phosphatase.



DAG is also hydrolysed by lipases leading to production of arachidonic acid (AA). Prostaglandins are important molecules in the regulation of endometrial processes such as menstruation, implantation and particularly that of parturition (Salamonsen et al 1999; Giudice 1999; Challis et al 1997).

Phospholipase D catalyses the hydrolysis of phosphatidylcholine with the production of phosphatidic acid (PA) and a free polar head group – inositol. Phosphatidic acid can be further cleaved by the enzyme phosphatidic acid phosphohydrolase (PAP) to form DAG which is a protein kinase C activator (Figure 7.3c).

Phospholipid turnover is now known to be mediated by numerous signals including neurotransmitters, releasing factors, hormones, growth factors, spermatozoa and Type I IFNs (Berridge 1991).

IFNs produce a variety of responses known to be associated with phospholipid turnover and phospholipid turnover generates all kinds of second messengers which could possibly mediate an IFN response. However, while phospholipid turnover has been linked to IFN signalling the relationship between Type I interferons and phospholipid signalling is unclear, although it does appear to be involved. IFN α stimulates diacylglycerol (DAG) production in HeLa cells which is accompanied by an increase in PC hydrolysis (Pfeffer et al 1990).

IFN α induces transcriptional responses with the activation of a cytoplasmic transcription factor known as interferon-stimulated gene factor (ISGF3) (Levy et al 1988) and an inhibitor of PKC blocks this activation (Reich and Pfeffer 1990). A possible activator of the ISGF3 is arachidonic acid (Kessler and Levy 1991).

Figure 7.4 Diagram of phosphatidylinositol showing sites of action of phospholipases A₂, C and D. R₁ and R₂ denote long chain hydrocarbons which are linked to the glycerol backbone and X denotes, in this case, an inositol polar head group, although it could be one of a variety of bases, for example, choline or ethanolamine.

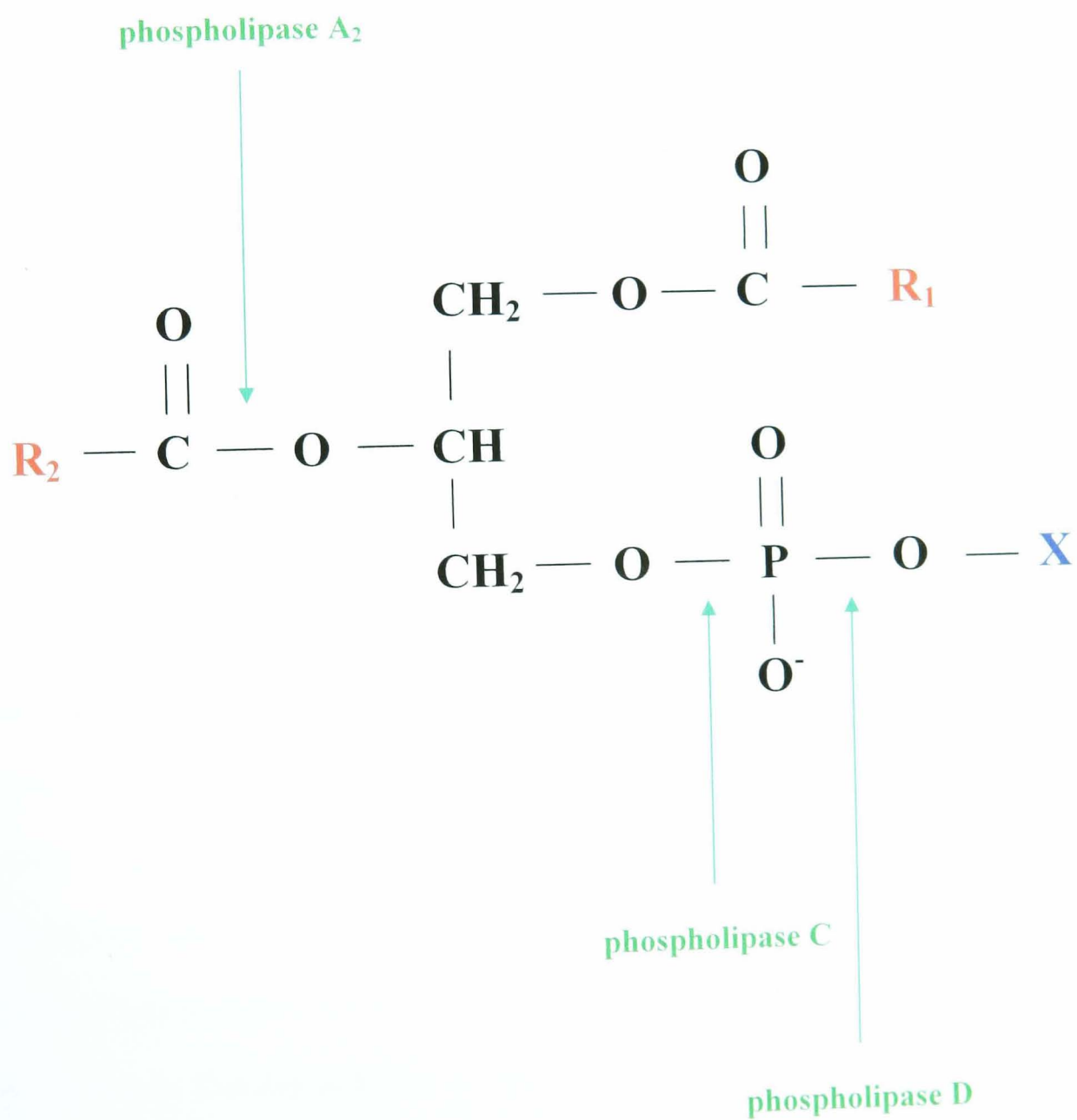

Subsequently, Cataldi and colleagues studied IFN α and β stimulated phosphoinositide hydrolysis in Daudi cells and human lymphocytes (Cataldi et al 1990 and 1995). In response to IFN α treatment of Daudi cells an increase in DAG mass was observed (Cataldi et al 1990), whilst IFN β treatment of human lymphocytes produced an increase in DAG levels associated with a rapid and transient PIP₂ hydrolysis derived from the sequential activation of the PLC and PLD pathways (Cataldi et al 1995).

Following the identification of the Type I interferon receptor (Class II cytokine receptor, Chapter 5 section 5.1) attention was focussed on the JAK (Janus kinases) and STAT (signal transducers and activators of transcription) proteins and the current model for IFN α and β signalling was established (see Chapter 8). Subsequently, work on the effects of Type I interferons on phospholipid turnover with the production of second messengers has been largely overlooked. However, it is important that phospholipid turnover in response to Type I IFNs continues to be investigated because to accept that the JAK/STAT pathway is the only signal transduction pathway through which the IFNs mediate their response may not be sufficient to explain the diversity of responses seen as a result of stimulation by the IFNs. It has already been shown that IFNs induce phospholipid turnover (Pfeffer et al 1990; Cataldi et al 1990 and 1995) and it is possible to conjecture, therefore, that the JAK/STAT pathway is perhaps regulated by second messengers generated by phospholipid turnover. However, to date, Type I IFN induced phospholipid turnover in the human endometrium has not been reported. Yet, induction of phospholipid turnover in endometrium has been reported as a result of oxytocin stimulation in the porcine endometrium which subsequently leads to prostaglandin secretion (Uzumcu et al 2000).

The aim of this thesis was to elucidate the mechanism by which Type 1 interferons exert their effects by using human endometrial cells as the model. Endometrial cells have been shown to undergo phospholipid turnover and respond to stimulation by IFNs. The IFN receptor has been well characterised in endometrial cells. So it is these properties that make endometrial cells a good model in which to study the mechanisms of Type I IFNs. It is known that Type I IFNs stimulate the JAK/STAT pathway in many cell types and in this study the stimulation of this pathway in human endometrial cells in response to IFNs α , β and τ was investigated as one of the possible mechanisms (see Chapter 9). Another possible mechanism is the stimulation of phospholipid turnover. In this chapter the following questions have been addressed:

- i) do Type I interferons stimulate phospholipid turnover in primary human endometrial cells *in vitro*?
- ii) and if so, what species of phospholipid are involved?

To examine Type I IFN-induced phospholipid turnover, primary human endometrial cells were prelabelled with [^{33}P] orthophosphate and then exposed to IFNs α , β and τ for increasing lengths of time. The phospholipids were extracted from the cells and then separated into their different types using TLC. The individual phospholipids were then removed from the TLC plated and counted to assess the change in radioactive content.

7.2 Methods

Before use, all glassware was thoroughly cleaned using chromic acid (75g of sodium dichromate initially dissolved in 100ml of distilled water followed by 1300ml of concentrated sulphuric acid) overnight, rinsed thoroughly in distilled water and then dried completely prior to siliconising using Sigmacoate (Sigma) to prevent adhesion of lipids to glass.

7.2.1 Extraction of lipids

The isolation of lipids from cells or tissues is neither simple nor straightforward and so it was important to recognise the potential problems in extraction procedures.

The most widely used method for extraction of total tissue lipids is that of Bligh and Dyer (1959). This procedure uses a mixture of chloroform and methanol in a ratio with tissue water of 1:2:0.4. However, there would be some loss of the polar phosphatidylinositols, so to increase the extraction of these lipids the method of Shukla and Hanahan (1984) was evaluated which uses an extraction mixture of chloroform:methanol:concentrated HCL (12N):0.5M EDTA in the ratio 200:400:5:1.6 v/v. The use of salt and acid solutions in the upper phase prevents the loss of the polar or acid phospholipids, for example, phosphatidylethanolamine, phosphatidylserine and phosphatidylinositol. Thus for experiments where phospholipid turnover was examined, the method of Shukla and Hanahan was used, while for experiments primarily investigating the release of diacylglycerol, Bligh and Dyer was the method of choice.

7.2.1.1. Extraction of total lipids by the method of Bligh and Dyer (1959)

Briefly, 1ml of endometrial cell suspension was extracted with 3.75ml of chloroform:methanol (1:2 v/v), followed by 1.25ml of chloroform and finally 1.25ml of distilled water. After the first two additions the mixture was shaken vigorously and left to

stand for 30 min at room temperature, following the final addition the mixture was shaken and left to stand overnight at 4°C. The lower organic phase was carefully removed into a siliconised tube and the aqueous phase was washed twice with 2ml of chloroform. All the organic phases were combined and blown dry under a stream of oxygen-free nitrogen. The residue was reconstituted in 2ml of chloroform:methanol (1:2 v/v).

7.2.1.2 Extraction of total lipids with an increased extraction of polar phospholipids by the method of Shukla and Hanahan (1984)

Briefly, the method follows that of Bligh and Dyer as described above except that 3.75ml of chloroform:methanol (1:2 v/v) was replaced with 3.75ml of chloroform:methanol:conc HCl:0.5M EDTA (200:400:5:1.6 v/v).

7.2.2 Thin layer chromatography methods

7.2.2.1 TLC for total lipids

Before carrying out any chromatography the solvent tank was prepared and equilibrated. The tank was rinsed with chloroform and dried in the fume hood. The solvent - methyl acetate, chloroform, n-propanol, methanol and 0.25% (w/v) potassium chloride (KCl) in the ratio 25:25:25:10:9 by volume – was added to the tank and mixed by gently swirling. Whatman filter paper was wrapped completely around the inside of the tank and the lid was firmly placed on top. The tank was left to equilibrate, that is when the paper was fully wetted with solvent.

The Whatman LHP-K plate was then spotted with the samples and standards phosphatidylethanolamine (PE), phosphatidylinositol (PI), phosphatidic acid (PA), phosphatidylserine (PS), phosphatidylcholine (PC) and lysophosphatidylcholine (LPC)

at a concentration of 1 mg/ml in individual lanes. One lane contained a combination of standards to verify separation.

The standards, if not already purchased in chloroform, were dissolved into chloroform to give a concentration of 1 mg/ml.

The plate was then placed in the chromatography tank until the solvent front was close to the upper edge of the plate when it was removed and air dried for about 15 min. The lipids were then visualised by placing the plate into a tank of iodine crystals for about 10 min or when the spots were clearly visible. The standards and unknowns were marked by lightly drawing around the spots with a pencil (Figure 7.6).

7.2.2.2 TLC for phosphoinositides

The silica gel 60 plates were pre-treated by spraying with a 1% (w/v) potassium oxalate solution and then heating to 110°C for 1 hour. To avoid any interference by Ca^{2+} on the mobility of PIP_2 Gonzalez-Sastro and Folch-Pi (1968) used plates including 1% potassium oxalate to bind any traces of Ca^{2+} . The tank was prepared as described for phospholipid TLC. The solvent system was chloroform:methanol:water:concentrated ammonia in the ratio 48:40:7:5 by volume.

The plate was run and visualised as described previously in section 7.2.2.1. The standards used were PE, PI, PA, phosphatidylinositol 4 phosphate (PIP) and phosphatidylinositol 4,5 bisphosphate (PIP_2) (Figure 7.5a).

7.2.3 Cell viability in phosphate-free medium

For the purposes of the following experiments in which phosphoinositide turnover was monitored by the production of radiolabelled phosphoinositides it was necessary to determine how long endometrial cells would remain viable in medium which contained no source of unlabelled phosphates.

Figure 7.5 (a) The separation of phosphoinositides by TLC using silica gel 60 plates impregnated with 1% (w/v) potassium oxalate and **(b)** the separation of phospholipids using Whatman LHP-K plates.

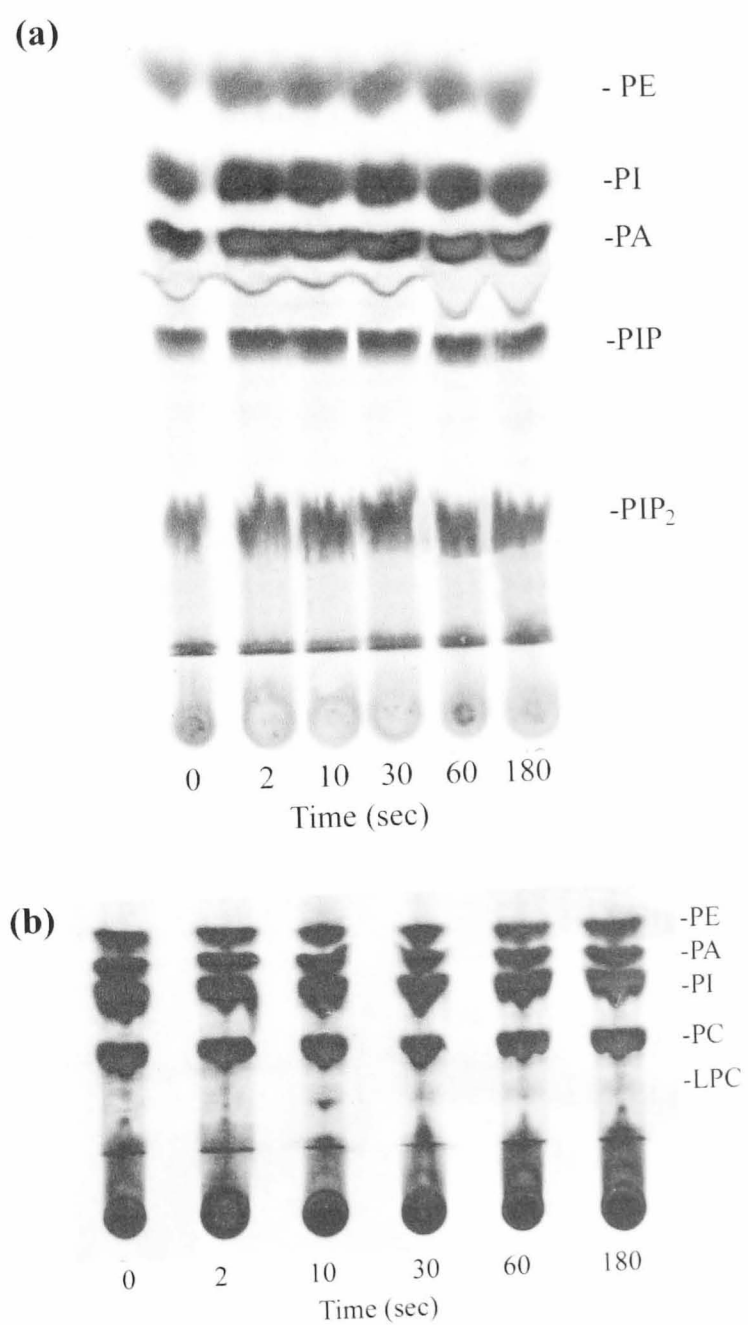

Two 75 cm² flasks containing cells at confluence were trypsinised as previously described and the cell suspensions were pooled into a silicon-coated glass tube. The tube was centrifuged for 5 min at 300 x g and the supernatant was discarded. The pellet of cells was resuspended in 1ml of medium which was free of phosphate, fetal calf serum, antibiotics and antimycotics. The suspension was centrifuged as before and the cells were once again resuspended in 1ml of depleted medium. The cells were then placed in the 37°C incubator but prior to this 100µl of the cell suspension was removed, this was time 0, and added to 5mls of fully supplemented media, as used in the cell culture protocol, which was then gassed and returned to the 37°C incubator for 1 hr. After this time, the tube was centrifuged, the supernatant discarded and 1ml of a 1:1 Trypan blue solution (in PBS) was added. After 5 min the sample was tipped into a Petri dish and the proportion of dead to live cells was ascertained by visualising several groups of 10 cells and taking the average. The above procedure was repeated by removing 100µl from the cell suspension in the depleted medium at 30 min, 1, 2, 2.5, 3.0, 3.5 and 4 hr from time 0.

7.2.4 Equilibration of [³³P] orthophosphate uptake by endometrial cells

Trypsinised endometrial cells were transferred to a siliconised glass tube and centrifuged at 300 x g for 5 min at room temperature. The cell pellet, after an initial wash in phosphate-free medium, was resuspended in 5.1ml of phosphate-free medium. 100µl of the cell suspension was removed for cell count. To 5 ml of cell suspension 25µl (250µCi) of [³³P] orthophosphate were added and mixed thoroughly. One millilitre of the suspension was removed immediately (time 0) and transferred into a siliconised glass tube containing 4ml of ice-cold 10mM PBS were added.

Following centrifugation at 300 x g for 5 min at RT, the supernatant was discarded and the pellet resuspended in 3ml of PBS which was divided into 3 x 1 ml aliquots which proceeded to lipid extraction using the methods of Shukla and Hanahan and Bligh and Dyer. The phospholipids and phosphoinositides were separated by TLC as previously described in section 7.2.2. The TLC plate was then exposed to X-Omat XAR-5 (Kodak) film using an intensifying screen overnight at -20°C. The film was then developed using an automatic developer (Department of Radiography, St Bartholomew's Hospital, London, UK). A 1ml cell suspension was removed at increasing time intervals (30, 60, 90, 120, 150 and 180 min), transferred into ice cold PBS and processed as described above. In each case, the remaining cell suspension was returned to the 37°C incubator and gassed periodically with 5% CO₂ in air. Once the sample of cell suspension had been removed all the steps leading to lipid extraction were executed as quickly as possible.

After visualisation (Figure 7.6) each individual phospholipid and phosphoinositide spot was scraped off the plate using a scalpel (and, if necessary, the silica gel was moistened with distilled water to prevent cracking) and put into a vial containing 5ml scintillation fluid. Each vial was capped and shaken vigorously and then allowed to settle in the dark before being counted on a β counter (Packard Minaxi 4000 series, Packard, Berkshire, UK) using the ³²P channel.

Until recently the most commonly used phosphorus isotope was ³²P. The counter used for the measuring [³³P] labelled phosphoinositides was designed to detect the β emitters ³H, ¹⁴C and ³²P. Although the counter did not have a channel dedicated to counting ³³P it would seem appropriate to count it on the ³²P setting. However, ³²P and ³³P have very different energies (1710 and 249 KeV respectively). In fact, the energy of ³³P is nearer to that of ¹⁴C at 155 KeV. The scintillation counter could be

programmed to measure one of three regions of energy, (i) 2-19 KeV, (ii) 4-156 KeV and (iii) 50-1700 KeV. The energy of ^{33}P falls just outside region (ii) and is at the low end of region (iii). Therefore, to ascertain which is the channel of choice one of the preliminary lipid extraction experiments was counted on all three channels and the resulting counts were compared (Table 7.1). There was not much difference in the counting efficiency of the ^{32}P and ^{14}C channels where there were many counts. However, the ^{32}P channel was more sensitive where there were fewer counts and, as a result of this comparison, the ^{32}P setting was used for all subsequent experiments.

Figure 7.6 Time course of ^{33}P uptake by phospholipids separated by thin layer chromatography. The migration of unlabelled standard material is indicated by pencil outline. PE = phosphatidylethanolamine, PI = phosphatidylinositol, PA = phosphatidic acid, PS = phosphatidylserine, PC = phosphatidylcholine and LPC = lysophosphatidylcholine.

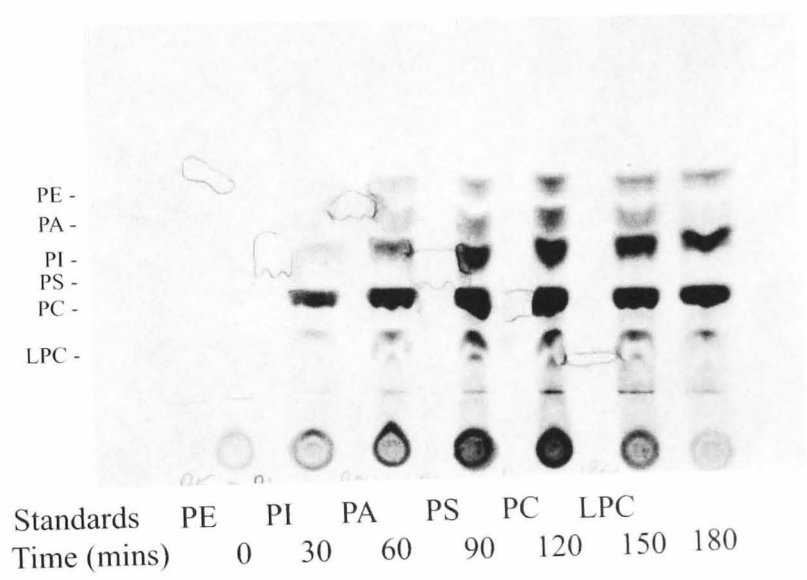

Table 7.1 A lipid extraction experiment was counted on the three channels available on the scintillation counter

experimental details	³² P channel cts/min	¹⁴ C channel cts/min	³ H channel cts/min
Blank 0'	19	26	15
PC 0'	56	49	22
LPC 30'	196	210	82
PC 30'	1468	1363	593
PS 30'	244	189	75
PA 30'	71	76	33
PE 30'	69	71	29
LPC 60'	524	423	217
PC 60'	4736	4363	1884
PS 60'	909	864	357
PA 60'	445	439	171
PE 60'	291	276	115
LPC 90'	902	820	343
PC 90'	8211	7453	3327
PS 90'	2194	1979	943
PA 90'	777	698	309
PE 90'	452	442	188

³³P has a half-life of 25.4 days and the experiments were carried out at various times from its reference date sometimes a month or more away. To correct for this an equation was devised so that the counts per 10⁵ cells could be adjusted for specific activity. Therefore, if an experiment took place using ³³P on, for example, day 1 or day 20, the counts would be adjusted to give values that would have been obtained on day 0 – the reference date of the isotope.

A graph was drawn of the decay profile of ^{33}P against the days from the reference date (Figure 7.7) and using this information the following formula was derived:

If there are 5×10^5 cells per ml removed at each time point and the isotope is 7 days from its reference date then it follows:-

$$X^a = X/5 \text{ per } 10^5 \text{ cells}$$

where X^a are the counts after adjusting for specific activity

X are the counts from the β counter

the decay from the graph for day 7 is 0.826, therefore, if counted on day 0

$$X^a = X/5 \times 1/0.826 \text{ per } 10^5 \text{ cells}$$

so $X^a = X/4.13 \text{ per } 10^5 \text{ cells}$

Figure 7.7 The decay profile of ^{33}P

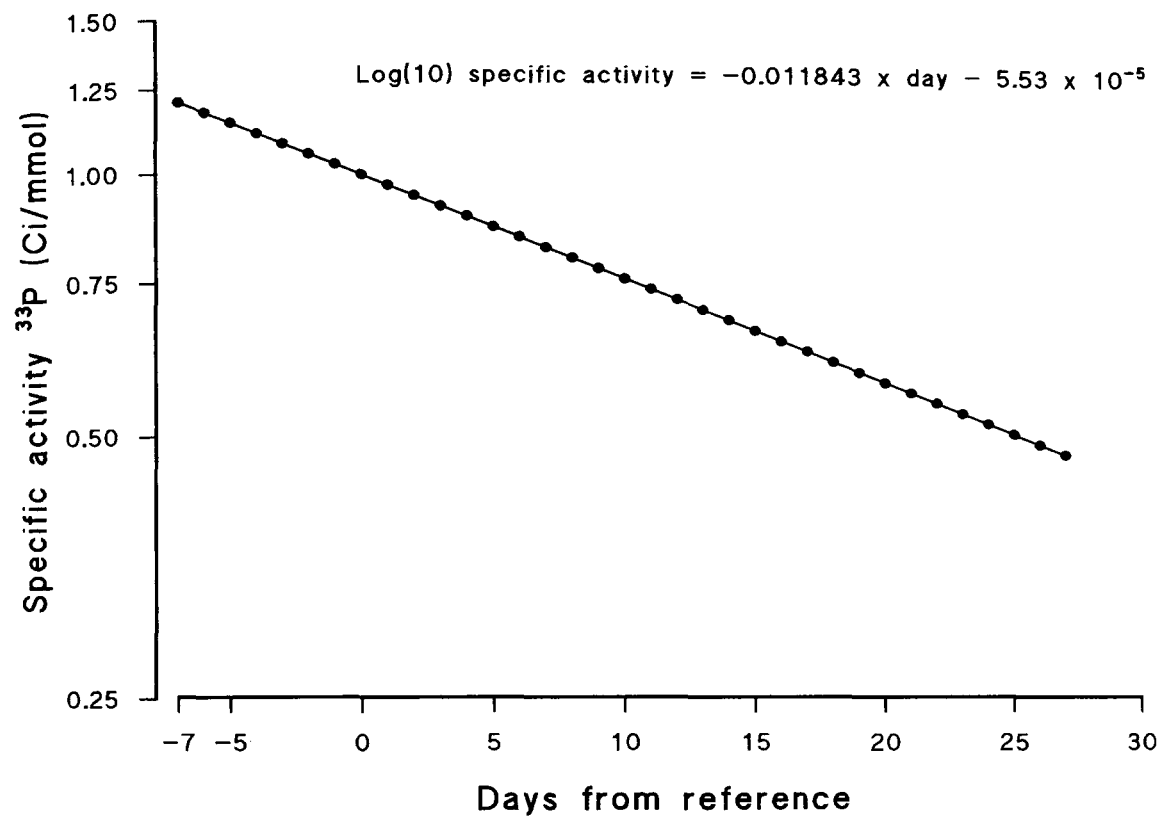

7.2.5 Phospholipid turnover following IFN stimulation

Endometrial cell suspensions were prelabelled with [³³P] orthophosphate for 90 min at 37 °C using the method previously described in section 7.2.4. After this time the cells were washed, centrifuged and resuspended in 6.5ml of 10mM PBS. One ml of cell suspension was aliquoted into 6 siliconised glass tubes. To the first tube 3.75ml of acidified chloroform:methanol was added (time 0). To subsequent tubes 2 through to 6, IFN (α , β or τ) at a concentration of 100 units per ml of cell suspension was added. Ice-cold acidified chloroform:methanol was added at 2, 10, 30, 60 and 120 second intervals. The phospholipids and phosphoinositides were extracted according to the method of Shukla and Hanahan and separated by TLC as previously described in sections 7.2. After autoradiography ³³P activity in the individual phospholipids and phosphoinositides was measured as described in section 7.2.4.

7.2.6 Equilibration of [³H] glycerol uptake in endometrial cells

Established endometrial cells were passaged on into 5 x 25 cm² flasks ensuring that cell numbers were approximately the same for each flask. These cells were grown to confluency at which point the old medium was discarded and replaced with 10ml of normal fully supplemented medium containing 20 μ Ci [³H] glycerol (2 μ Ci [³H] glycerol per ml of medium). The flasks were gassed and returned to the 37°C incubator. The uptake of [³H] glycerol was assessed at 3, 6, 24, 30 and 48 hr after its addition to the flasks. At the allotted time point a flask was taken and the cells trypsinised as previously described in section 7.2.4. One millilitre of the resulting cell suspension was extracted using the method of Bligh and Dyer. After drying down in a stream of N₂ the precipitate was resuspended in scintillant, poured

into a vial and then counted using the ^3H channel on the scintillation counter. The levels of [^3H] glycerol at the given time points were compared.

7.2.7 Measurement of diacylglycerol levels following IFN stimulation.

Endometrial cells were grown to confluency and prelabelled with [^3H] glycerol for 48 hr as previously described in section 7.2.6. One millilitre of cell suspension was aliquoted into 6 siliconised glass extraction tubes. To the first tube 3.75 ml of ice-cold chloroform:methanol (1:2 v/v) was added (time 0). To the other 5 tubes 100 μl of IFN (α , β or τ), at a concentration of 100 units per ml of cell suspension, was added for 2, 10, 30, 60 and 120 sec the reaction being stopped by the addition of 3.75 ml of ice-cold chloroform:methanol. The phospholipids were extracted using the method of Bligh and Dyer and separated by TLC. TLC for mono-, di- and triacylglycerol used a Silica gel 60 plate and the solvent system was hexane:ether:methanol:acetic acid in the ratio 180:40:6:4 by volume. Tritiated glycerol cannot be visualised by conventional autoradiography therefore to aid visualisation of the sample spots in iodine vapour a small amount of the unlabelled standards were run with the samples. The mono-, di- and triacylglycerol spots were scraped off the plate and put into vials containing scintillant and counted.

7.3 Statistical analysis

The data obtained from the analysis of phosphoinositide production and hydrolysis in response to different stimuli was normally distributed and the paired T test was used to compare values.

In all cases, differences between the groups were considered significant when the probability of the events occurring by chance was < 0.05 .

7.4 Results

7.4.1 Cell viability in phosphate-free medium

To allow the maximum uptake of [³³P] orthophosphate into endometrial cell phospholipids, the cells should, ideally, be cultured in the presence of radiolabel but in the absence of unlabelled phosphate. As the addition of radiolabel would represent such a minute source of phosphate for the cells, it was necessary to determine the viability of cells in phosphate-free medium. Endometrial cells were cultured in the absence of phosphate for up to 4 hours and the viability assessed at regular intervals using the Trypan Blue exclusion method. The experiment shows that the majority of endometrial cells remain viable in phosphate-free medium for at least 90 minutes which allows enough time for the equilibration of [³³P] orthophosphate (Table 7.2).

Table 7.2 Endometrial cell viability with increasing incubation time in phosphate-free medium (cell count represents mean of 4 experiments).

Time (minutes)	Mean number of non-viable cells per 10 cells	% live cells
0	1.0	90
30	2.0	80
60	2.5	75
90	2.5	75
120	4.5	55
150	5.0	50
180	7.0	30
210	7.5	25
240	7.5	25

7.4.2 Equilibration of [³³P] orthophosphate uptake in endometrial cells

To determine the rate of uptake of radiolabelled [³³P] orthophosphate, cells were cultured for an increasing period of time in phosphate-free media to which the radiolabel was added. At various times, phospholipids were extracted by the method of Shukla and Hanahan (1984), as described in Materials and Methods, to determine the incorporation of [³³P] orthophosphate. The experiments demonstrated that unstimulated human endometrial cells from primary culture rapidly incorporated the radiolabel into the various phospholipid classes within 60 mins of exposure to [³³P] orthophosphate. There were no statistically significant increases in the uptake of [³³P] orthophosphate after 90 mins (Figure 7.8 A and B). For all subsequent experiments examining phospholipid turnover in response to IFN, endometrial cells were prelabelled with ³³P for 90 mins prior to stimulation.

Figure 7.8 A and B. Uptake of [^{33}P] orthophosphate into phospholipids by human endometrial cells. A. ^{33}P uptake into the phospholipids PC, PI/PS, LPC and PE (n=3). B. ^{33}P uptake into the phospholipids PI, PA, PIP and PIP_2 (n=2). Error bars represent SEMs.

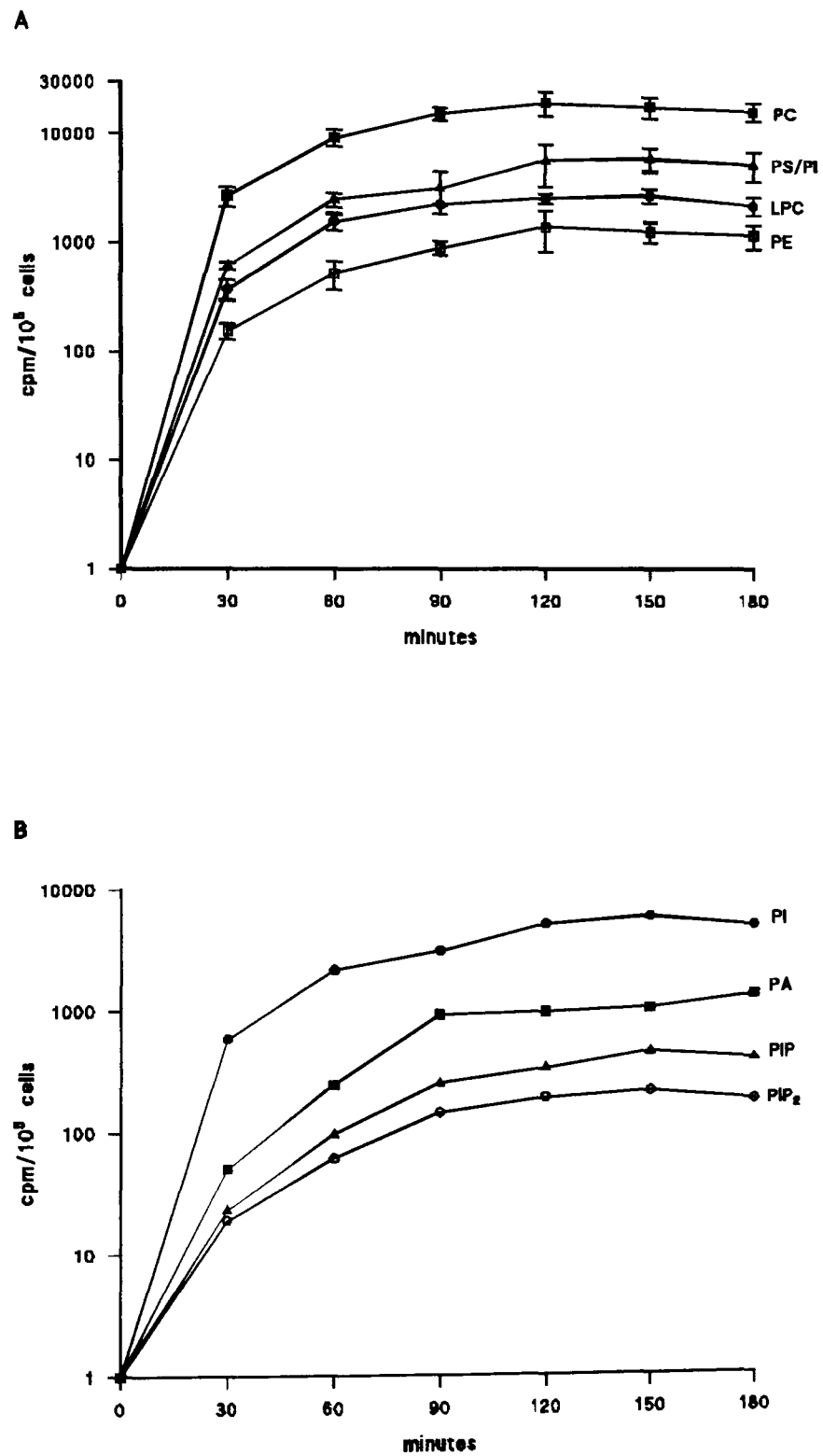

7.4.3 Phospholipid turnover following stimulation by IFN α

Primary endometrial cells, pre-labelled with [^{33}P] orthophosphate, were stimulated with IFN α (100 units per ml of cell suspension) and the reaction was stopped at 2, 10, 30, 60 and 120 second intervals. The phospholipids and phosphoinositides were then extracted, separated and counted as previously described in this chapter. The response of endometrial cell phospholipids to stimulation by IFN α is summarised in Table 7.3. The data in Table 7.3 shows the means and SEMs calculated on counts from three experiments. The counts for each experiment are represented as a percentage of the total counts incorporated into the cells initially. This data (means and SEMs) is represented graphically in Figure 7.9.

There is significant hydrolysis of PIP $_2$ at 2 seconds ($p = 0.007$) with a significant recycling of PIP $_2$ from 2 seconds to 10 seconds ($p = 0.029$).

In addition, there is significant hydrolysis at 2 seconds of PIP ($p = 0.038$) and PA ($p = 0.040$).

There was no significant hydrolysis or production of any of the other phospholipids.

7.4.4 Phospholipid turnover following stimulation by IFN β

The methods used were the same as those described for stimulation by IFN α , section 7.4.3. The response of endometrial cell phospholipids to stimulation by IFN β is summarised in Table 7.4.

Table 7.3 IFN α induced changes in [^{33}P] orthophosphate labelled endometrial cell phospholipids with time. The values are given as cpm/ 10^5 cells.

lipid	Time in seconds					
	0	2	10	30	60	120
PIP₂						
n	3	3	3	3	3	3
mean	9144	5786	7411	7021	7002	7133
SEM	1574	1624	1104	1421	1962	875
PIP						
n	3	3	3	3	2	3
mean	8653	7361	8123	7750	7731	7764
SEM	1651	1393	1350	1308	2156	969
PI						
n	3	3	3	3	3	3
mean	22692	21959	25284	22471	23518	23128
SEM	3518	2230	4001	3585	3109	3654
PA						
n	3	3	3	3	3	2
mean	9023	6843	7369	8666	5909	5805
SEM	204	717	660	2055	644	1034
PC						
n	3	3	3	3	3	2
mean	37600	29093	27556	29903	25055	26537
SEM	8225	3735	5060	2320	3752	5843
PE						
n	3	3	3	3	3	2
mean	3187	2872	2959	3166	2589	2438
SEM	177	402	527	800	543	163
LPC						
n	3	3	3	3	3	2
mean	8072	6573	8585	8129	8704	7603
SEM	637	1245	857	1185	1425	1353

Figure 7.9 Endometrial cell phospholipid response to IFN α represented as a percentage of the total counts incorporated initially (means \pm SEMs). * indicates significant hydrolysis of PIP₂, PIP and PA at 2 seconds ($p = 0.007$, 0.038 and 0.04 respectively) and # indicates significant recycling of PIP₂ between 2 and 10 seconds ($p = 0.029$).

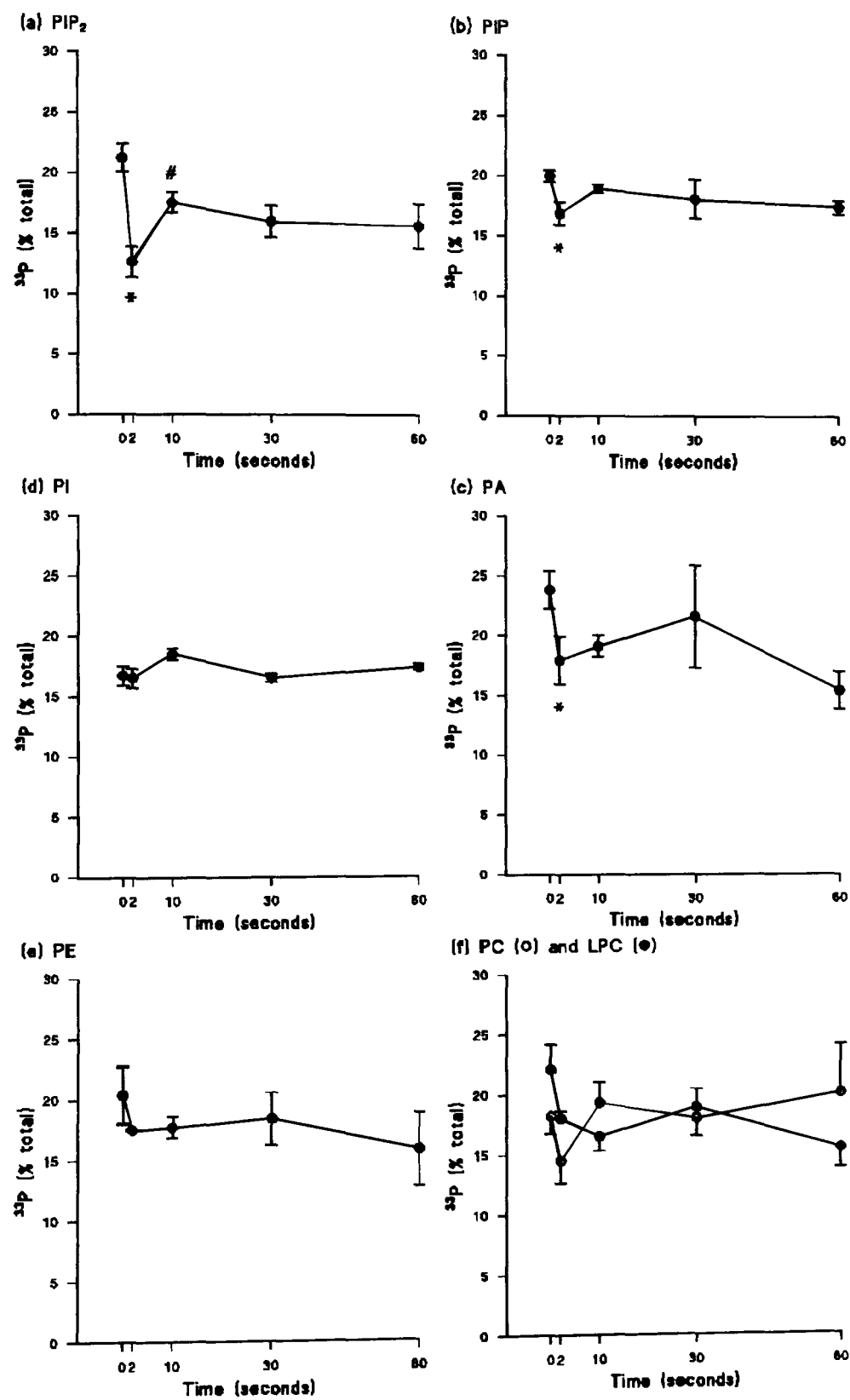

Table 7.4 shows the means and SEMs calculated on the raw data. Figure 7.10 shows the same data represented as a percentage of the total counts added at the beginning of each experiment.

There is no significant hydrolysis or production of any of the phospholipids following stimulation by IFN β .

7.4.5 Phospholipid turnover following stimulation by IFN τ

The methods used were the same as those briefly described for stimulation by IFN α , section 7.4.3. The response of endometrial cell phospholipids to stimulation by IFN τ is summarised in Table 7.5.

Table 7.5 shows the means and SEMs calculated on the raw data. Figure 7.11 shows the same data represented as a percentage of the total counts added at the beginning of each experiment.

In response to IFN τ there is no significant hydrolysis of PIP₂ at 2 seconds but there is significant hydrolysis of PIP₂ at 10 seconds ($p = 0.048$) with maximal hydrolysis at 30 seconds ($p = 0.0007$). Following hydrolysis, there is significant recycling of PIP₂ from 30 to 60 seconds ($p = 0.014$).

Similarly, there is significant hydrolysis of PIP at 10 seconds ($p = 0.012$) with maximal hydrolysis at 30 seconds ($p = 0.0004$) followed by significant recycling of PIP from 30 to 60 seconds ($p = 0.05$) although at 60 seconds levels of hydrolysed PIP are still significantly reduced ($p = 0.003$).

There is no significant hydrolysis or production of any of the other phospholipids measured.

Table 7.4 IFN β induced changes in [^{33}P] orthophosphate labelled endometrial cell phospholipids with time. The values are given as cpm/ 10^5 cells.

lipid	Time in seconds					
	0	2	10	30	60	120
PIP₂						
n	5	5	5	5	5	4
mean	13283	15330	13590	14749	12315	12501
SEM	1962	3357	4103	4930	3130	3445
PIP						
n	5	5	5	5	5	4
mean	9197	11394	9934	10499	9337	8427
SEM	1567	2875	2951	3109	2485	3074
PI						
n	5	5	5	5	5	4
mean	24145	27388	25432	27997	26125	26038
SEM	2260	3860	5172	4747	4269	5795
PA						
n	5	5	5	5	5	4
mean	34757	43630	40284	42367	40601	38312
SEM	10912	14083	14086	14186	13087	16089
PC						
n	3	3	3	3	3	2
mean	21330	29117	29356	27422	31730	29873
SEM	3855	8501	9884	7887	7627	13116
PE						
n	5	5	5	5	5	4
mean	5935	7489	6598	7939	7042	6277
SEM	2085	2721	2752	3173	2520	3036
LPC						
n	3	3	3	3	3	2
mean	1232	1475	1531	1948	1766	1687
SEM	104	223	326	185	145	231

Figure 7.10 Endometrial cell phospholipid response to IFN β represented as a percentage of the total counts incorporated initially (means \pm SEMs).

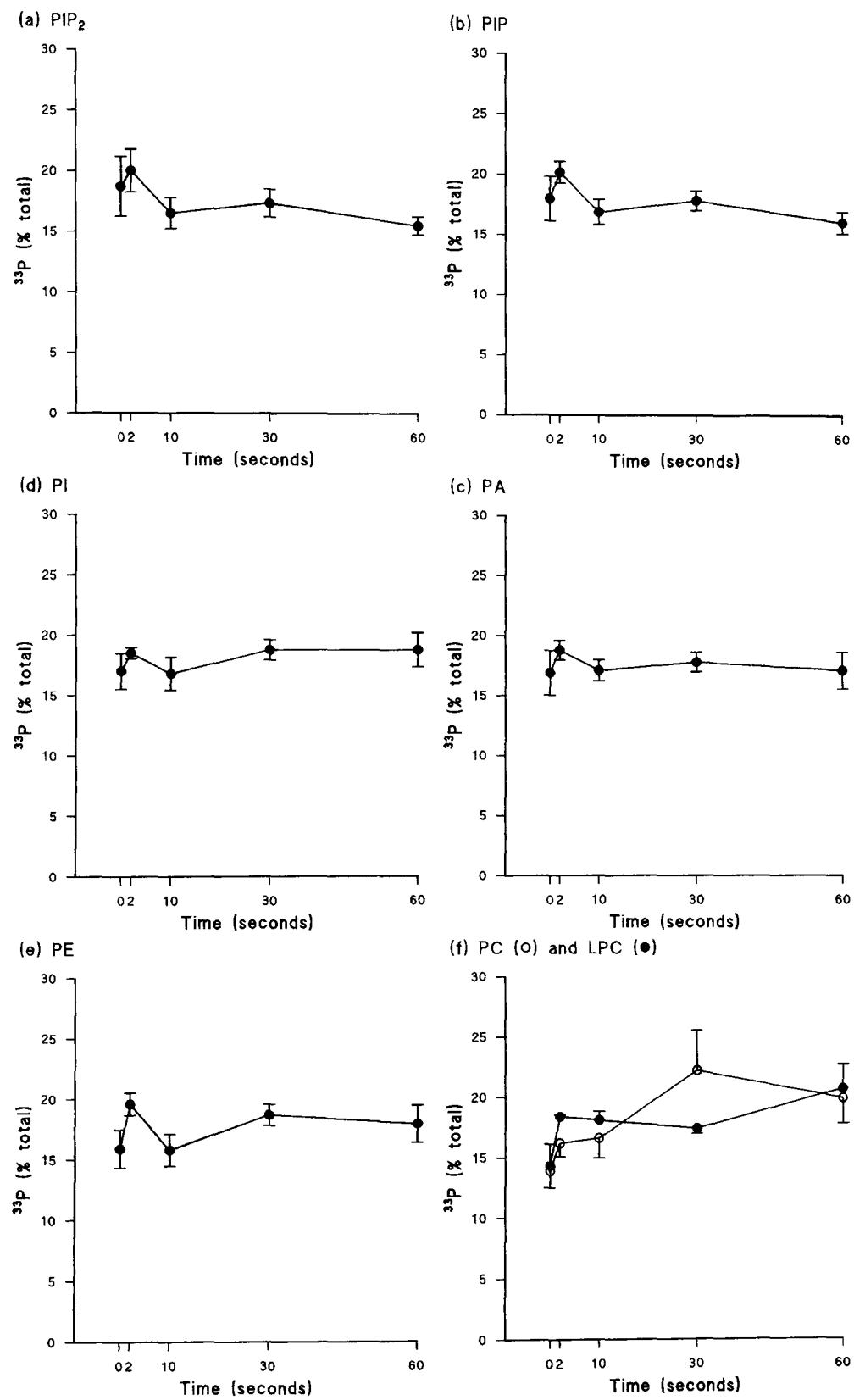
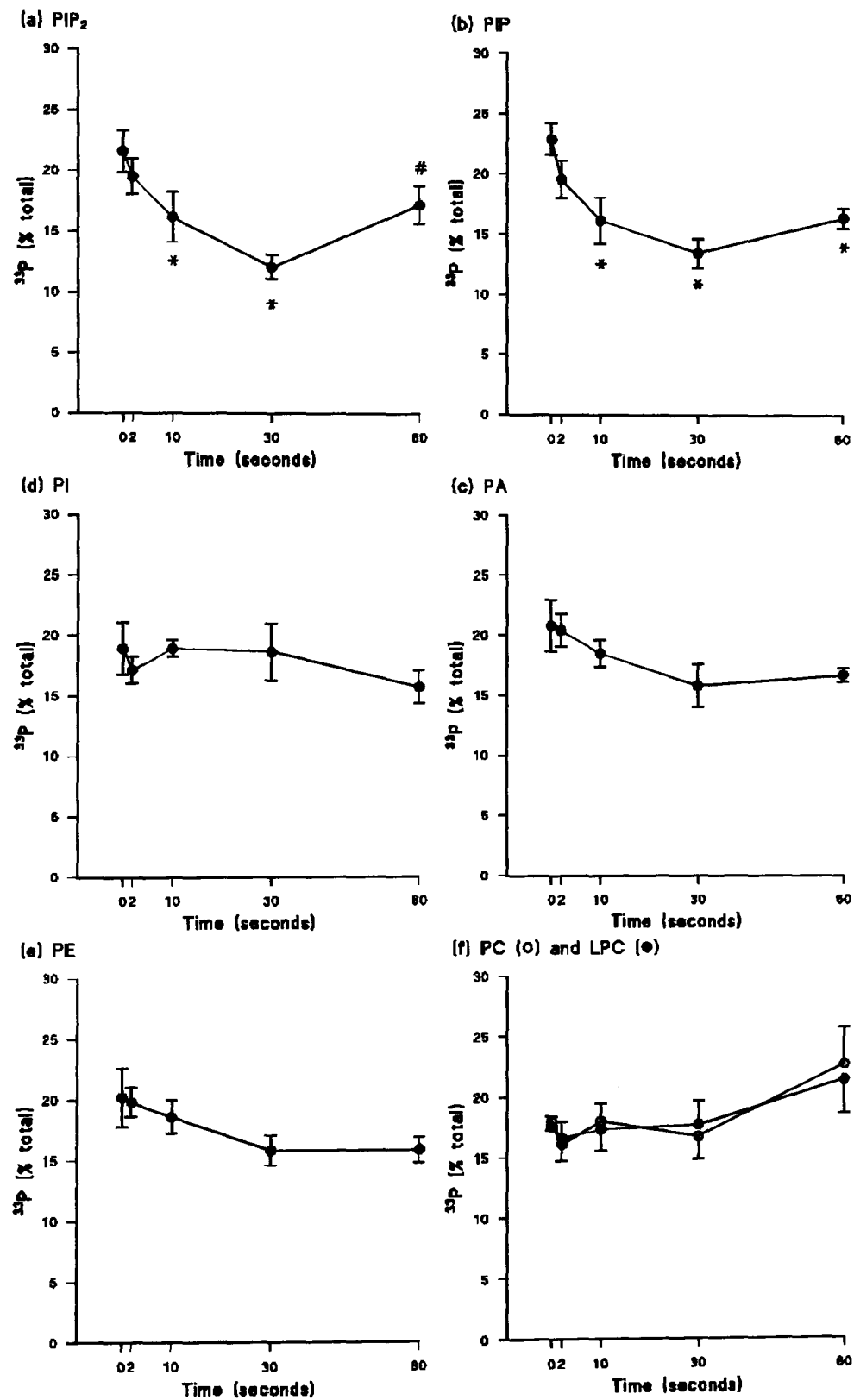

Table 7.5 IFN τ induced changes in [^{33}P] orthophosphate labelled endometrial cell phospholipids with time. The values are given as cpm/ 10^5 cells.

lipid	Time in seconds					
	0	2	10	30	60	120
PIP₂						
n	6	6	6	6	5	6
mean	4828	4443	3699	2720	3740	3541
SEM	634	704	771	388	698	776
PIP						
n	6	6	6	6	5	6
mean	4497	3728	3299	3020	3030	3112
SEM	486	534	554	415	469	476
PI						
n	5	5	5	5	4	5
mean	17087	16230	16879	17137	15487	15857
SEM	2618	2542	3264	3447	3651	1977
PA						
n	5	5	5	5	4	5
mean	10997	10617	9698	8711	9953	9410
SEM	1506	1544	1877	1445	2001	1048
PC						
n	6	6	6	5	5	6
mean	28026	25537	27599	29031	27420	28349
SEM	5891	5591	6748	7300	4784	5113
PE						
n	5	5	5	5	4	5
mean	1707	1638	1440	1301	1241	1207
SEM	301	201	187	166	60	179
LPC						
n	6	6	6	5	5	6
mean	2657	3413	3150	2327	2982	2846
SEM	703	926	872	685	1052	503

Figure 7.11 Endometrial cell phospholipid response to IFN τ represented as a percentage of the total counts incorporated initially (means \pm SEMs). * indicates significant hydrolysis of PIP₂ and PIP at 10 and 30 seconds ($p = 0.048$, 0.0007 and 0.012 , 0.0004 respectively) and PIP at 60 seconds ($p = 0.003$). # indicates significant recycling of PIP₂ and PIP from 30 to 60 seconds ($p = 0.014$ and 0.05 respectively).



7.4.6 Equilibration of [³H] glycerol uptake in endometrial cells.

Production of DAG was measured using incorporation of [³H] glycerol.

To determine the rate of uptake of radiolabelled [³H] glycerol, unstimulated cells were cultured for up to 72 hours in media to which the radiolabel was added. At various times total lipids were extracted by the method of Bligh and Dyer (1959) and the neutral lipids were separated by TLC, as previously described in section 7.2.2. The experiments demonstrated that unstimulated human endometrial cells from primary culture incorporated the radiolabel into diacylglycerol after 48 hours of exposure (Figure 7.12). For all subsequent experiments examining diacylglycerol turnover in response to IFN, endometrial cells were prelabelled with [³H] glycerol for 48 hours prior to stimulation.

7.4.7 Diacylglycerol turnover following stimulation by Type I interferons

The methods used were basically the same as those briefly described for stimulation by IFN α , section 7.4.3. The response of endometrial cell diacylglycerol to stimulation by Type I IFNs is summarised in Table 7.6.

Table 7.6 shows the means and SEMs calculated on the raw data. Figure 7.13 shows the same data represented as a percentage of the total counts added at the beginning of each experiment.

In response to stimulation by IFN α there is significant production of DAG at 2 seconds ($p = 0.009$) followed by a significant hydrolysis of DAG from 2 to 10 seconds ($p = 0.019$).

There is no significant production or hydrolysis of DAG on exposure to IFN β .

On exposure to IFN τ there was significant production of DAG at 10 seconds ($p = 0.04$) and this production was more significant at 60 seconds ($p = 0.026$).

Figure 7.12 Uptake of [^3H] glycerol into diacylglycerol by human endometrial cells over time.

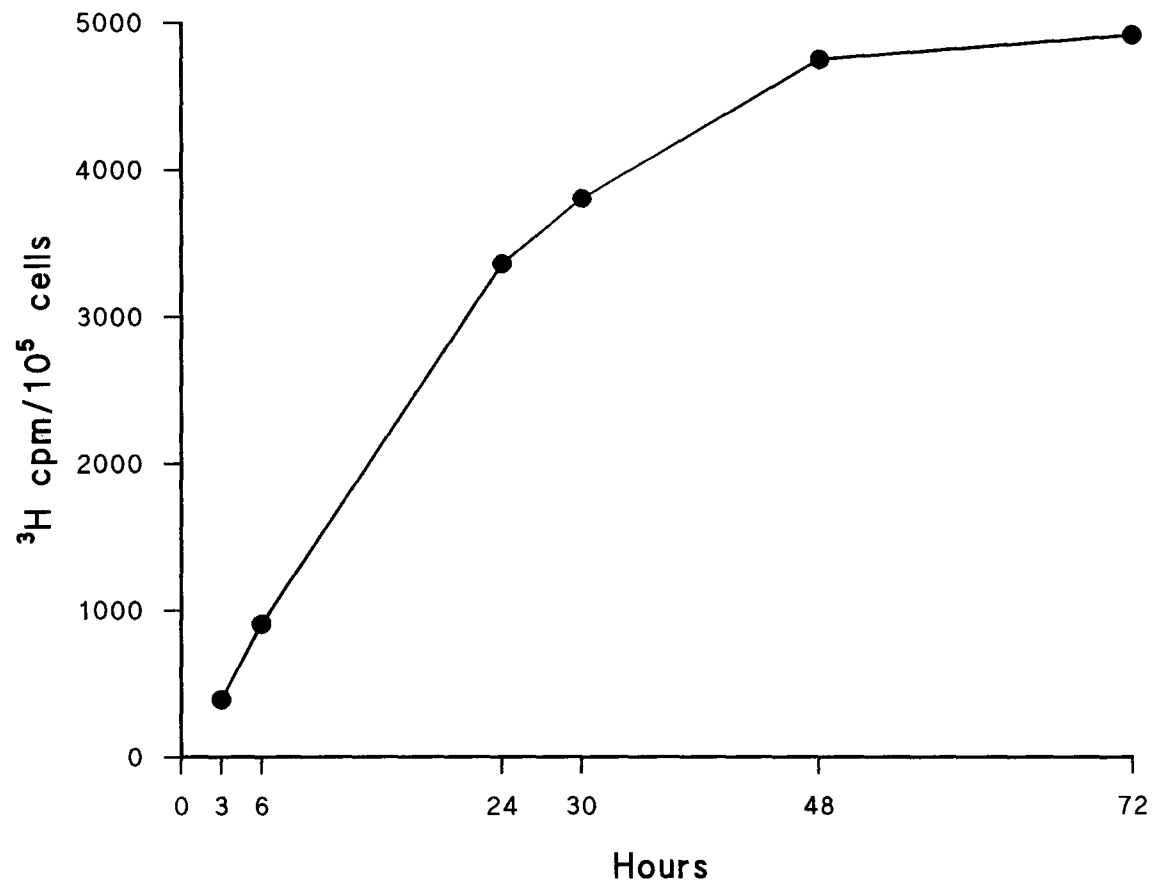
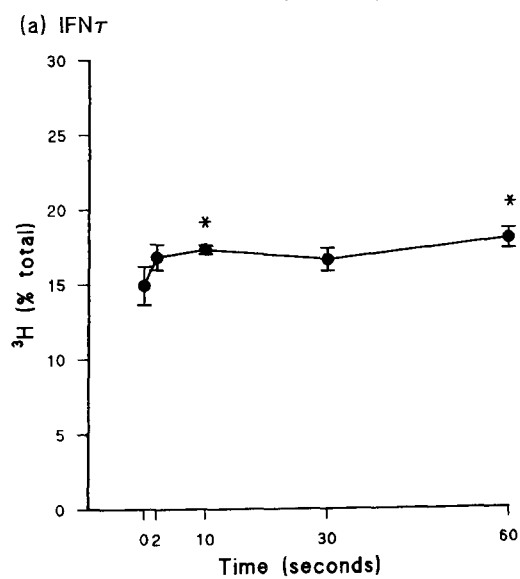
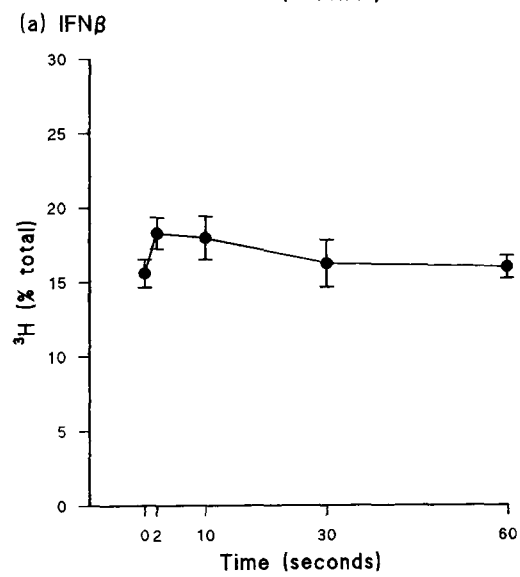
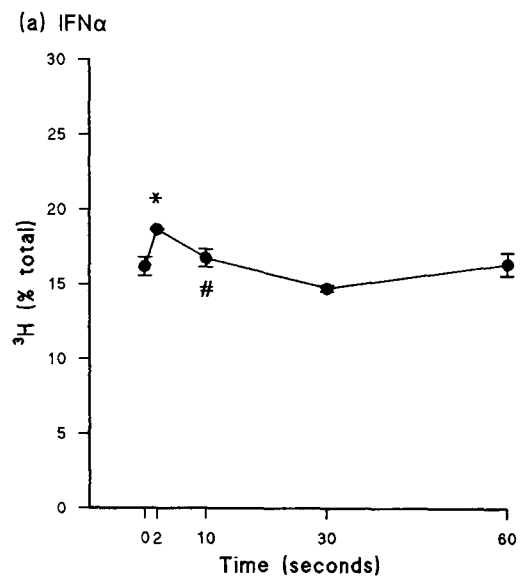

Table 7.6 IFN α , β and τ induced changes in [^3H] glycerol labelled endometrial cell diacylglycerol (DAG) with time. The values are given as cpm/ 10^5 cells.

IFN	Time in seconds					
	0	2	10	30	60	120
IFNα						
n	3	3	3	3	3	3
mean	292	332	296	261	283	300
SEM	107	116	100	89	85	102
IFNβ						
n	5	5	5	5	5	5
mean	363	400	414	353	370	372
SEM	70	69	78	74	65	37
IFNτ						
n	5	5	5	5	5	5
mean	207	228	231	199	238	235
SEM	28	34	26	25	19	32

Figure 7.13 Endometrial cell diacylglycerol response to IFNs α , β and τ represented as a percentage of the total counts incorporated initially (means \pm SEMs). * indicates significant production of DAG. # indicates significant hydrolysis of DAG.



7.5 Discussion

These experiments show for the first time that IFNs α and τ activate phospholipid signalling pathways in primary endometrial cells *in vitro*. In contrast, IFN β is not apparently associated with any phospholipid signalling pathway.

7.5.1 The response to IFN α

This study shows that IFN α stimulates rapid hydrolysis of PIP₂, PIP and PA in primary human endometrial cells with a concomitant release of DAG at 2 secs. DAG and IP₃ are rapidly recycled to form PIP₂ (see Figure 7.2) which is shown in these experiments by the significant incorporation of label into PIP₂ at 10 seconds with significant decrease in radiolabelled DAG at the same time. In response to IFN α there is significant decrease of PIP at 2 seconds. Some of these findings agree with other studies which found that the interaction of IFN α with other cell types, Daudi and HeLa cells, stimulates the production of DAG (Cataldi et al 1990; Pfeffer et al 1990).

However, neither of these previous studies detected phosphoinositide turnover in response to IFN α , although one group found an increase in PA which paralleled that of DAG formation (Pfeffer et al 1990). This disparity of results could be because of the different cell types used; which would, therefore, support the theory that IFNs can activate different signalling mechanisms in different cell types and, in doing so, can have different effects.

However, there is an alternative explanation. In the current study the hydrolysis of the phosphoinositides and the production of DAG occurred within 2 seconds of exposure to IFN α . It is known that the initial event following the binding of the ligand to its receptor is a rapid formation of second messengers usually within 30

seconds. The studies which report no phosphoinositide turnover may not see a change because their experimental procedures have the first time points for the measurement of the phospholipids at 1 and 2 minutes after IFN stimulation (Cataldi et al 1990; Pfeffer et al 1990). It could be argued, therefore, that these previous studies have missed the response and that the investigators were looking at levels of phospholipids which have returned to those found prior to IFN exposure. Alternatively, it could be because different cell types are involved, DAG can be generated by the action of phospholipase C on PIP₂ with the simultaneous production of another second messenger IP₃. The results reported here suggest that IFN α -receptor binding activates a PLC to produce a signalling mechanism involving phosphoinositide turnover. In addition, the results suggest that PA turnover is also involved. The levels of PA are significantly reduced even at 1 minute ($p = 0.01$) PA can be hydrolysed by the enzyme phosphatidic acid phosphohydrolase to form DAG (Figure 7.3 C). Therefore, the increase in DAG seen after IFN α stimulation may be derived not only from PIP₂ but also from PA.

7.5.2 The response to IFN β

The results of the present study show that IFN β does not stimulate hydrolysis of any of the phosphoinositides investigated nor does it stimulate production of DAG in primary human endometrial cells. This is in contrast with the findings in human lymphocytes and Daudi cells where exposure to IFN β led to an increase in DAG together with hydrolysis of PIP₂ in the former (Cataldi et al 1995) and an increase in DAG production but no changes in the levels of PI, PIP or PIP₂ in the latter (Yap et al 1986). Yap and colleagues measured this change in DAG within 30 seconds of exposure of IFN β but, in the present study, there was no significant increase in

labelled DAG from 2 to 60 seconds and at 30 seconds ($p = 0.469$). This could again reflect differences in response to IFNs depending upon cell types.

However, for this study the cells were stimulated with 100 units of IFN β per ml of cell suspension whereas Yap and colleagues used 20,000 units/ml IFN β . These high levels of IFN β are way beyond those found *in vivo* and the observations in the study presented here are more likely to represent the physiological situation. There is no evidence to suggest that IFN β is detectable in normal tissue unless stimulated in some way or by external administration. Following subcutaneous administration, serum levels of IFN β between 40-475 IU/ml, depending upon the method of measurement used, have a marked effect on the course of multiple sclerosis (Khan et al 1996). It would, therefore, be possible to assume that levels of approximately 100 units/ml of IFN β would be sufficient to cause an effect in cells that are responsive.

Likewise, Cataldi and colleagues used a ten-fold higher concentration of IFN β (1000 IU/ml) to stimulate the human lymphocytes compared to the concentration used in the current study.

It would appear that the response to IFN β is very different to IFN α in endometrial cells with respect to phospholipid signalling which may reflect the different binding affinity of IFN β for the endometrial IFN receptor.

Although IFN α and β transmit their actions via the same IFN α/β receptor there is much evidence to suggest that there is differential interaction of α and β IFNs with their receptor. Mutant IFNAR-2 proteins in the N-terminal subdomain confer complete resistance to IFN α but not to IFN β whilst, in complete contrast, an alanine substitution of Tyr 127 in IFNAR-2 prevents IFN β binding but not IFN α binding (Lewerenz et al 1998). Certain highly conserved amino acids in the loops of the IFN

α/β receptor are important for functional IFN α binding because mutational studies reveal that substitution of these amino acids reduce the binding of IFN α but not that of IFN β (Runkel et al 1998). Studies have shown that both IFN α and IFN β need to make physical contact with IFNAR-1 and IFNAR-2 for intracellular signal transduction although IFNAR-1 appears to engage IFN β differently than IFN α (Novick et al 1994; Lutfalla et al 1995; Rani et al 1996). Differences have been observed between cell signalling by IFN α and IFN β . Mutant U1A cells are completely defective in response to recombinant or natural IFN α but retain a partial response to IFN β (Pellegrini et al 1989). Identification of a gene which is selectively induced by IFN β , but not IFN α , provides further evidence that IFN β may use a distinct pathway for cell signalling (Rani et al 1996). It is also of interest that IFN α and IFN β , although both Type I interferons having many characteristics in common, are, structurally, only 30% homologous. Therefore, it may be possible to speculate that the IFN receptor found on human endometrial cells is more suited for IFN α binding rather than IFN β binding.

These studies may go some way in explaining that phospholipid signalling pathway is not triggered in response to IFN β on primary human endometrial cells.

7.5.3 The response to IFN τ

This data shows for the first time that IFN τ can stimulate a response through the IFN α/β receptor on human endometrial cells *in vitro*.

At the present time there is no published data on the activation of phospholipid signalling mechanisms by IFN τ in any cell type, although there is a single report on the effects of IFN τ (OTP) on oxytocin-induced phosphatidylinositol turnover in sheep endometrium (Vallet and Bazer 1989). The results of the experiments carried out for

this study show that IFN τ stimulates the hydrolysis of PIP₂ and PIP with maximal hydrolysis taking place at 30 seconds after exposure to IFN τ ($p = 0.0007$ and 0.0004 respectively). The patterns of PIP₂ and PIP hydrolysis are very similar but are different to that seen with IFN α . The response to IFN τ is far less rapid than that by IFN α . Significant hydrolysis is first seen at 10 seconds (PIP₂ $p = 0.048$; PIP $p = 0.012$), not 2 seconds as with IFN α , and this hydrolysis continues to be significant becoming maximal at 30 seconds. This is followed by significant production of both PIP₂ and PIP (PIP₂ $p = 0.014$; PIP $p = 0.05$) by 60 seconds after exposure to IFN τ although these levels have not returned to those found prior to stimulation by IFN τ . The pattern of DAG production mirrors that of PIP₂ and PIP hydrolysis. There is a significant increase in DAG production in response to IFN τ at 10 seconds ($p = 0.04$) and there is continued production with levels still significantly raised at 60 seconds ($p = 0.026$).

IFN α and IFN τ bear a striking sequence homology, approximately 70% (Stewart et al 1987; Imakawa et al 1987), and they share a common receptor in the bovine endometrium (Li and Roberts 1994). The ovine Type I interferon receptor (oIFNAR1) is a 560 amino acid transmembrane protein which has 80% homology with the human IFNAR1 and 95% homology with the bovine IFNAR1 (Kaluz et al 1996). It appears from the results obtained in this study that IFN τ binds to the IFN α/β receptor on human endometrial cells and that this interaction stimulates a similar pattern of phospholipid turnover. The response is not as rapid as that which occurs with IFN α (figure 7.9 and figure 7.11) and is slow to return to pre-stimulated levels. The relative slowness of the response may be due to differences in the IFN α and IFN τ interaction with the IFN receptor. In this regard it is of interest to note that

studies have shown that IFN τ can slow the proliferation of bovine kidney epithelial cells and human WISH cells whereas the same concentration of IFN α significantly inhibit growth (Pontzer et al 1991). Subramaniam and colleagues found that although IFN τ is as potent an antiviral and antiproliferative agent as IFN α on MDBK cells, it is far less cytotoxic at the same concentrations and this cytotoxicity is associated with maximal receptor occupancy (Subramaniam et al 1995). They found that IFN α at high concentrations has approximately a 10-fold lower K_d , and hence a greater binding affinity for the receptor than does IFN τ . The higher binding affinity of IFN α for the receptor and the differential competition properties of IFN τ and IFN α also suggest that these IFNs recognise the receptor differently (Subramaniam et al 1995). This report may help to explain why we observe minor differences in phospholipid signalling in response to stimulation by IFN α and τ .

However, the phospholipid response to IFN α and IFN τ stimulation in endometrial cells is very similar compared to the lack of response observed when the cells are stimulated with IFN β . IFN α and IFN τ are structurally very similar, 70% homology, whereas the structural similarity between IFN α and IFN β is only 30%. This difference may possibly help to explain the differences in response.

In summary, this study shows that Type I interferons stimulate phospholipid turnover in human primary endometrial cells. We found a distinct difference in the activation of this pathway between the IFNs tested. The greatest response followed incubation with IFN α and IFN τ , whereas IFN β did not stimulate this pathway. These differences may be explained by differences in the structures of these IFNs and their interaction with the IFN receptor.

CHAPTER 8

**DETERMINATION OF THE PRESENCE OF JAK
AND STAT PROTEINS IN UNSTIMULATED
ENDOMETRIAL CELLS**

8.1 Introduction

8.1.1 The classic IFN signalling pathway

The elucidation of IFN signalling via the JAK and STAT pathway began with studies of IFN-inducible genes in the early 1990s. It was known that when Type I IFNs bind to their receptor the end point is transcriptional activation of a sequence called the IFN-stimulated response element (ISRE) in the absence of *de novo* protein synthesis (Sen and Lengyel 1992; Darnell et al 1994). This DNA sequence is present in IFN α and IFN β inducible genes. For the activation of ISRE containing genes a complex known as IFN-stimulated gene factor 3 (ISGF3) is required. ISGF3 is present in an inactive form in the cytoplasm where it becomes activated immediately after IFN receptor binding. The activated ISGF3 complex moves to the nucleus and binds to the ISREs. What was less certain was how the signal was transduced from the initial binding of the ligand to the receptor through to the activation of the ISRE. It had been reported that certain protein kinases blocked IFN-induced gene expression (Sen and Lengyel 1992) and that IFN α binding caused activation of phospholipase A₂ with the formation of arachidonic acid in mouse fibroblasts (Hannigan and Williams 1991).

Further studies showed that the ISGF3 complex consisted of two biochemically distinct activities. The α component (ISGF3 α) was shown to be rapidly and specifically activated in the cytoplasm in response to IFN α . The γ component, ISGF3 γ , also known as p48 or interferon regulatory factor-9 (IRF-9), was found to be present in both cytoplasmic and nuclear compartments and possessed intrinsic DNA binding activity (Levy et al 1989). Later it was demonstrated that ISGF3 α was made

up of 3 proteins p84, p91 and p113 all of which contain one SH2 domain and a weak SH3 domain.

The potential involvement of kinases in the signal transduction mechanism had already been suggested by previous studies and with the use of antibodies against the ISGF3 proteins it was shown that IFN α and IFN β activate the rapid tyrosine phosphorylation of the three ISGF3 α proteins (Pellegrini and Schindler 1993). These events trigger the association of these proteins which form the ISGF3 α complex and translocate to the nucleus. These proteins serve dual roles as signal transducers as well as activators of transcription and so the generic name of STAT (Signal Transducers and Activators of Transcription) was given to this family of proteins (Darnell et al 1994). Proteins p91 and p84 are STAT1 α and STAT1 β respectively and p113 is STAT2.

The family of STATs consists of six mammalian members which participate in numerous signalling pathways (Briscoe et al 1994; Ihle and Kerr 1995). The STAT proteins contain several conserved regions scattered throughout their entire length including a highly conserved SH2 domain and a conserved tyrosine residue carboxy-terminal of the SH2 domain. SH2 domains bind phosphotyrosine residues. STAT activation requires protein tyrosine phosphorylation at the conserved carboxy-terminal tyrosine (Darnell et al 1994). The non-phosphorylated STATs exist as monomers in the cytoplasm and upon phosphorylation they form homo- or heterodimers through interactions of their SH2 domains and the phosphotyrosine residues. The tyrosine phosphorylation of the STATs occurs at the cell membrane in association with the receptor components. STAT2 is probably constitutively associated with the IFNAR2 subunit of the IFN α / β receptor.

Activation of STAT1 at the IFN receptor depends upon the presence of STAT2 and receptor engagement.

As a result of studies using IFN response mutant cell lines a gene, *tyk2*, was identified as being responsible for restoring the mutant cell's response to IFN α . This gene encodes a protein tyrosine kinase lacking a SH2 domain but containing two kinase-like domains. This protein kinase was named Tyk2 and is necessary for the IFN α / β response (Pellegrini and Schindler 1993). A further protein tyrosine kinase was identified as being necessary for a response to IFN α and IFN β and this was called JAK1.

The JAK family is a novel family of cytoplasmic kinases which are involved in the signalling of a wide range of cytokines. The acronym JAK stands for Janus kinase which refers to the two-faced Roman god of gates and doorways and the JAKs' structural feature of two kinase domains. In mammals, there are 4 family members (JAK 1, JAK 2, JAK 3 and Tyk 2). JAKs uniquely contain two kinases homology domains JH1 and JH2. Experiments using mutant cell lines show that a pair of JAKs are required for Type I interferon signalling. JAK 1 is required for signalling through both the Type I and Type II interferon receptors, whereas Tyk 2 is necessary for IFN α / β responses and JAK 2 for IFN γ signalling (Velazquez et al 1992; Muller et al 1993). There is interdependence between the pairs of kinases – if either pair is missing, the remaining kinase is not activated.

JAKs associate with conserved motifs in the membrane proximal region of the receptor. There is constitutive association of Tyk 2 with IFNAR1 and JAK 1 with IFNAR2 subunits of the IFN α / β receptor (Novick et al 1994; Abramovich et al 1994; Colamonici et al 1994). Protein tyrosine phosphorylation is a key reaction in the

activation of cytokine receptors (Velazquez et al 1992; Levy 1995; Hague and Williams 1998).

However, unlike most growth factor receptors, the cytokine receptors do not possess any cytoplasmic tyrosine kinase domain, instead they constitutively associate with members of the JAK family of tyrosine kinases that provide tyrosine kinase activity necessary for receptor activation and subsequent signal transduction (Velazquez et al 1992; Ihle and Kerr 1995; Stark et al 1998).

In summary, IFN α and IFN β binding to the Type I IFN receptor leads to dimerisation of the different subunits of the receptor. This receptor aggregation brings JAK1 and Tyk2 into close proximity through their constitutive association with receptor subunits. This results in tyrosine phosphorylation of the receptor components. The phosphotyrosine residues in the receptor complex recruit STAT1 and STAT2 through their SH2 domains which are, in turn, phosphorylated on their carboxy-terminal tyrosine residue. The activation of the STAT proteins leads to dimerisation of the proteins to form the complex ISGF3 α . This complex moves into the nucleus where it associates with the 48kD DNA-binding protein, ISGF3 γ /IRF-9, and forms a stable multimeric complex, ISGF3, on the ISRE with the IRF-9 protein interacting directly with the DNA (Figure 8.1).

Figure 8.1. The mechanism of Type I interferon signalling via the JAK/STAT pathway (A-D).

Key to symbols:

● represents the ligands IFN α and IFN β , ● represents tyrosine phosphorylation

A The initial event in cell signalling by the Type I interferons is the activation of the cell surface cytokine class II receptor by IFN α and IFN β .

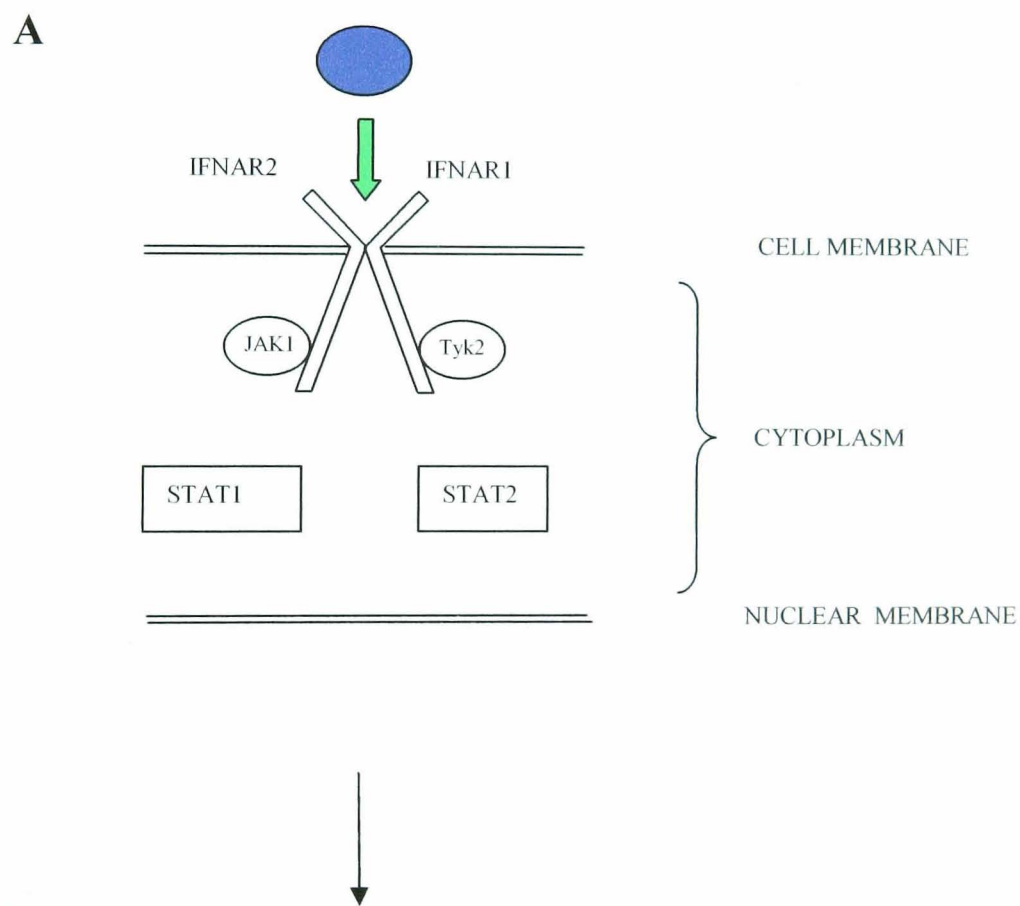

B The signalling mechanism is initiated when, after ligand-receptor binding, the receptor subunits dimerize bringing the associated kinases, JAK1 and Tyk2, into close proximity. This action results in tyrosine phosphorylation and an increase in catalytic activity.

B

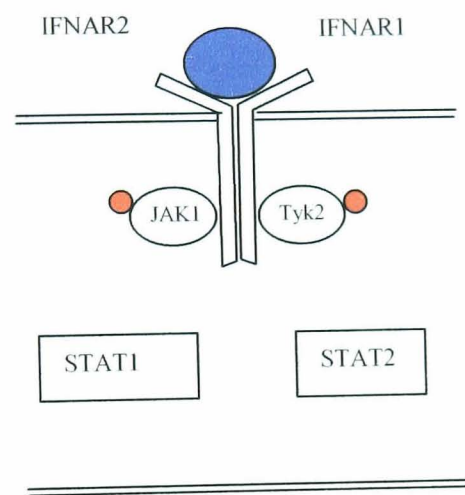

C The phosphotyrosine residues in the receptor complex recruit STAT1 and STAT2 through their SH2 domains which, in turn, are phosphorylated. The activation of the STATs facilitates heterodimerization of the proteins by SH2-phosphotyrosine interactions leading to the formation of the ISGF3 α . The ISGF3 α then translocates to the nucleus and the DNA-binding protein p48/IRF-9 (ISGF3 γ).

C

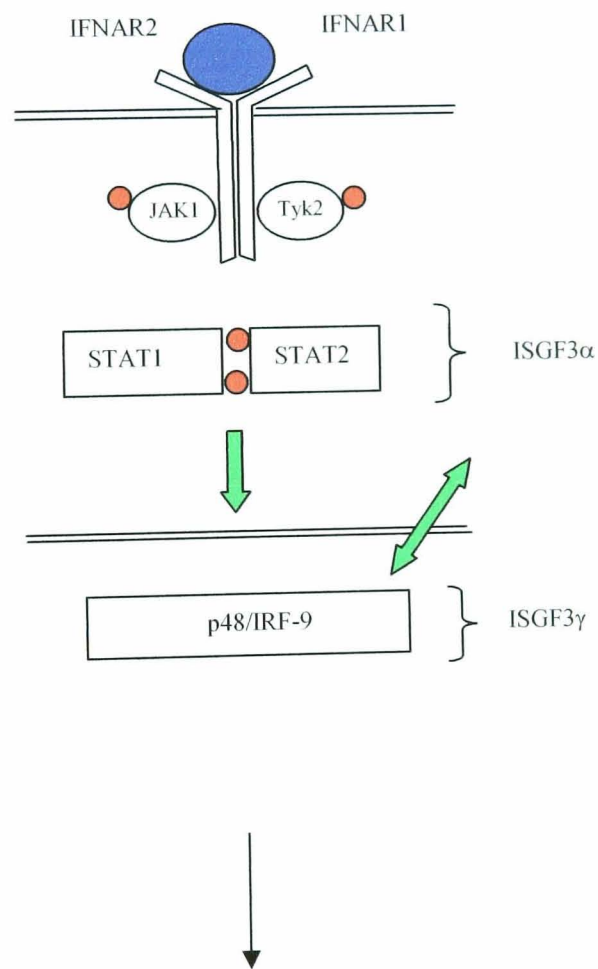

D Within the nucleus the ISGF3 α associates with the DNA-binding protein p48/IRF-9 (ISGF3 γ) to form a stable ISGF3 complex on the ISRE. This association leads to the induction of the target genes.

D

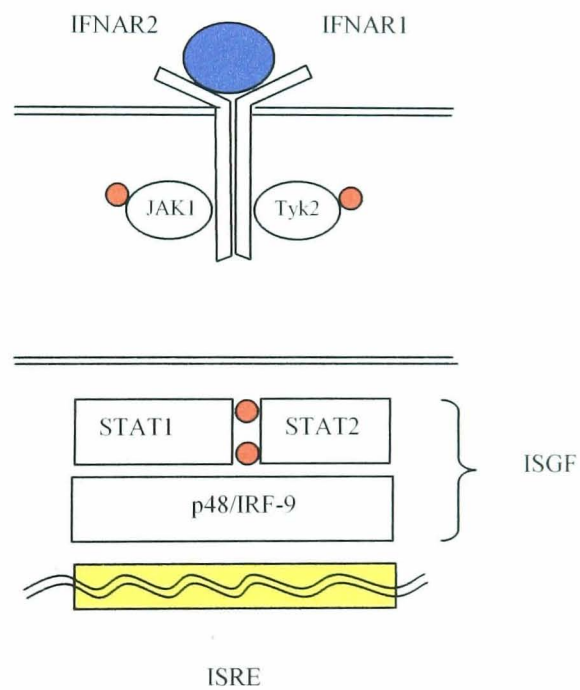

It is known that Type I IFNs stimulate the JAK/STAT pathway in many cell types but, to date, there have been no reports showing the activation of the JAK/STAT pathway in response to Type I IFNs in human endometrial cells in culture. However, it has been shown that the Type I IFN, IFN τ , activates the JAK/STAT pathway, with the tyrosine phosphorylation of STATs 1 and 2, in bovine and ovine endometrial epithelial cells (Stewart et al 2001; Binelli et al 2001). However, before any of the stimulation experiments involving human endometrial cells were carried out it was important to determine that JAK and STAT proteins were present in human endometrial cells in culture as this had not been previously reported. It was also possible that even if these proteins were present in endometrial cells it may be difficult to culture enough primary human cells to produce adequate quantities of these proteins for the experiments to be carried out (Dr Ian Kerr, personal communication).

8.2 Methods

8.2.1 Immunoprecipitation of the JAK and STAT proteins

The method for the immunoprecipitation of the JAK and STAT proteins was carried out according to the protocols provided by Dr Ian Kerr, ICRF, London.

Three x 10⁶ unstimulated endometrial cells, 2 x 10⁶ control cells U3C (STAT 1 α negative) and 2 x 10⁶ control cells U4C (JAK 1 negative) were lysed in 500 μ l of lysis buffer. Each lysate was placed in an Eppendorf tube and put on ice for 15 min mixing vigorously at regular intervals throughout this time. The cells were then centrifuged at 4 °C for 5 min at 13 000 x g. The cell supernatants were then immunoprecipitated overnight at 4°C using polyclonal rabbit antibodies to JAK1 and STAT 2 and

monoclonal antibodies to STAT1 α together with 50 μ l of Protein A sepharose (prepared as a 50% slurry in lysis buffer).

8.2.2 SDS-PAGE

The gel was prepared by pouring the freshly made resolving gel solution between two 20 cm x 20 cm glass plates separated by 1 mm spacers. The gel was left to set and to prevent oxidation the top of the gel was covered with a solution of butan-1-ol saturated with water. After the gel had solidified the butanol solution was decanted and the top of the gel rinsed several times with water before adding the stacking gel. Once this solution had been added the 10 well comb was carefully put into place between the glass plates and the gel was left to set.

The immunoprecipitated cell lysates prepared in section 8.2.1 were centrifuged for 5 minutes at 13,000 x g at 4°C and the supernatant was discarded (if necessary the supernatant could be cleaned with a protein A Sepharose incubation followed by immunoprecipitation with different antibodies from those already used). The protein A Sepharose beads were washed once in lysis buffer and once in wash buffer. The resulting pellet was resuspended in 50 μ l of loading buffer then boiled for 5 min prior to loading onto the gel. Molecular weight markers were used for size estimation and run in one or more lanes. The samples were run through the stacking gel at 150 V (Volts) and 105 mA (milliAmps) and through the resolving gel at 255 V and 222 mA in running buffer. The electrophoresis was stopped when the bromophenol blue line reached the bottom of the gel.

8.2.3 Western blotting

Western blotting involves transferring proteins, previously separated by SDS-PAGE, onto polyvinylidene fluoride (PVDF) membranes. A small proportion of this protein in the membrane re-folds to its native conformation and can therefore be probed for immunoreactivity to a given antibody. Proteins contained within the polyacrylamide gel maintain a negative charge and they can be transferred onto PVDF membranes by applying a current across the gel enabling the proteins to migrate at 90 ° to the gel and onto the membrane. The PVDF membrane was cut to fit the gel and soaked in methanol for a few minutes. Meanwhile the gel was removed from the electrophoresis tank and placed on a bed of approximately 6 Whatman filter papers wetted with transfer buffer. The moistened PVDF membrane was placed onto the gel and more wet filter papers placed on top of that. To ensure there was good contact between all the components it was important to remove all traces of air. This was done by gently rolling a pipette across the membrane and then the papers. This 'sandwich' of gel, membrane and filter paper was placed between two pads of Scotchbrite and the two parts of the cell which were placed into the vertical transfer tank ensuring at all times that the gel faced the cathode and the membrane faced the anode.

The transfer was carried out at 4 °C overnight using 0.1 A. The timings had been assessed by the efficiency of the transfer of the pre-stained protein markers. After the transfer the membranes were rinsed in TBST + vanadate and then blocked for 1 hr at 4 °C in 5% BSA in TBST + vanadate with 0.01% sodium azide (NaN₃). After blocking, the membrane was washed in TBST (no vanadate) and then incubated on a

rocking platform overnight at 4°C in TBST + 1% BSA + 0.01% NaN₃ containing the primary antibody (antibody specific to the protein of interest).

8.2.4 Detection of proteins by enhanced chemi-luminescence (ECL)

After incubation with antibody solution the membrane was washed for 5 min x 3 in TBST to ensure the removal of NaN₃. The membrane was then incubated for 45 min at room temperature with secondary anti-mouse or anti-rabbit peroxidase conjugated antibodies at 1 in 1500 dilution in TBST + 1% BSA. The membrane was then washed extensively with TBST for at least 1 hr with as many changes of buffer as practical. The membrane was then visualised using the ECL kit. This involved mixing the ECL reagent '1' with reagent '2' in equal volumes and then pouring them onto the surface of the blot. The solution was left for 1 min after which time the unbound reagent was drained off and the membrane was blotted gently with filter paper. The blot was placed in cling film and then exposed to X-Omat XAR-5 (Kodak) film for 30 seconds to 3 min and then developed using an automatic developer (Department of Radiography, St Bartholomew's Hospital, London, UK).

The membrane could be stripped with 2M glycine.HCl pH 2.5 for 30 min, neutralised with 1M Tris.HCl pH 7.4 and then rinsed in TBST before re-probing with other specific antibodies.

8.3 Results

Using 3×10^6 human endometrial cells it was possible to detect the presence of unactivated JAK and STAT proteins – JAK1, Tyk2, STAT1 α and 2. (Figure 8.2).

Figure 8.2 (A) shows that following immunoprecipitation and Western blotting with anti-JAK1 a band corresponding to a molecular weight of approximately 100 kDa can be seen in the lane containing U3C cells. This band was not seen in lysates from U4C cells which are known to be JAK1 deficient (Muller et al 1993) but was also present in lysates from primary human endometrial cells.

In Figure 8.2 (B) a band of protein corresponding to a molecular weight of approximately 115-120 kDa, that of Tyk2, can be seen in lanes 1, 2 and 3 following immunoprecipitation with anti-Tyk2. Control cell lines U3C and U4C are not deficient in Tyk2 and therefore act as positive controls. This protein band is also present in primary human endometrial cell lysates although to a lesser extent confirming that Tyk2 can be found in endometrial cells.

Immunoprecipitation and Western blotting with anti-STAT1 α gives rise to a band in U4C lysates of approximately 90kDa and a similar band can be seen in human endometrial cell lysates. U3C cells, deficient in STAT1 α (Muller et al 1993) show no band at all so confirming that STAT1 α is present in human endometrial cells (Fig 8.2 C).

Figure 8.2 (D) shows bands migrating to an approximate molecular weight of 113 kDa, that of STAT2, in U3C, U4C and human endometrial cell lysates.

Figure 8.2 Autoradiographs showing the presence of JAK1 (A), Tyk2(B), STAT1 α (C) and STAT2 (D) in cultured human endometrial cells. Control cell lines U4C (JAK1 negative) and U3C (STAT1 α negative) are also shown.

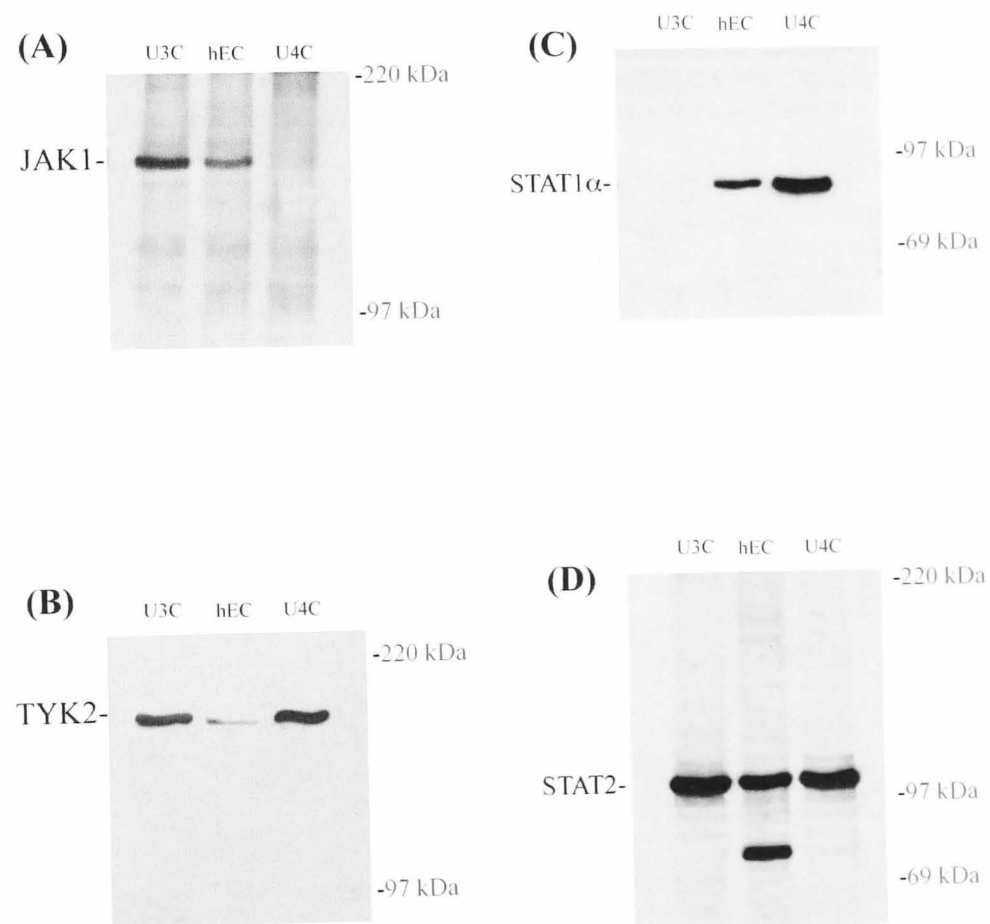

The protein bands of JAK1, Tyk2 and STAT1 α (Fig 8.2 A, B and C) in human endometrial cell lysates are very similar to those found in the control cell lysates in that they all appear as single bands. However, in endometrial cell lysates STAT2 has a second band of protein at approximately 80-90 kDa. Using a Ferguson plot of \log_{10} molecular weight against distance migrated by the molecular weight it was possible to calculate the approximate molecular weight for the lower molecular weight band of STAT2 to be 84 kDa (Fig 8.3). Both molecular weight forms of STAT2 protein appear to be present in endometrial cell lysates in equal quantities.

Figure 8.3 Ferguson plot of Log_{10} molecular weight against distance migrated by molecular weight for STAT2 proteins

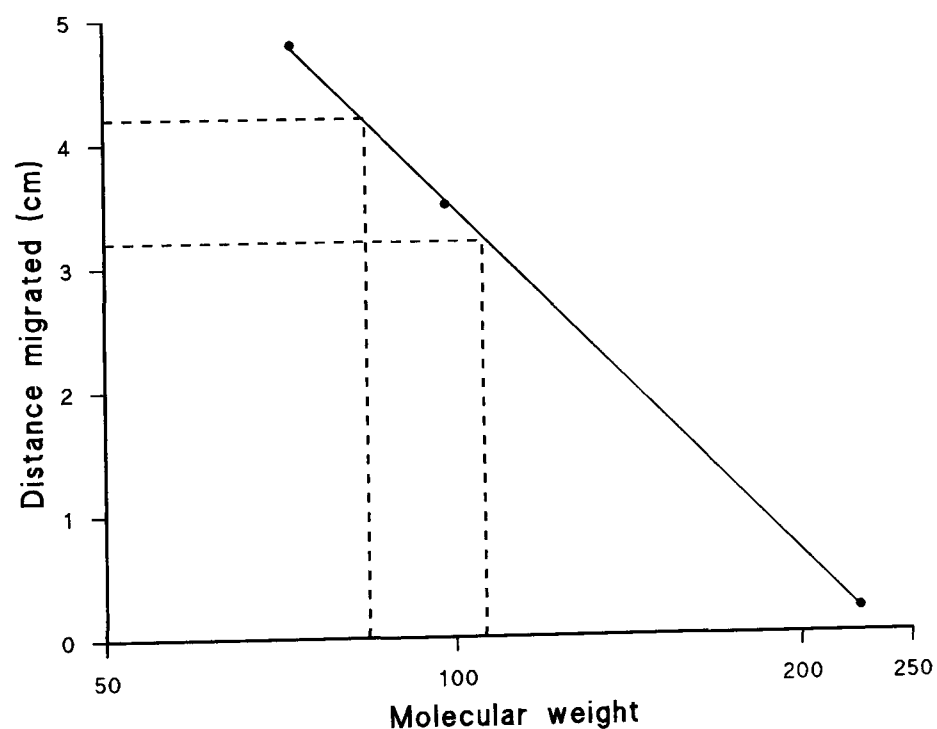

In all cases the protein bands corresponding to the JAK and STATs in human endometrial cell lysates are less intense than their counterparts in the control cell lysates.

8.4 Discussion

STAT1 α expression has been reported in cultured human endometrial cells (Zoumpoulidou et al 2004). However, to our knowledge this is the first time that expression of other members of this signalling pathway, JAK1, Tyk2 and STAT2 has been demonstrated.

One area of concern associated with the investigation into the activation of JAK and STAT proteins in response to Type I IFN stimulation was the possibility that there would not be enough endometrial cells cultured to produce JAK and STAT proteins in adequate quantities to be detected by the experimental methods.

The results show that JAK1, Tyk2, STAT1 α and STAT2 could be detected in 3×10^6 endometrial cells in culture. As a consequence, it was possible to carry out the investigation into the activation of these proteins in response to Type I IFNs (see Chapter 9).

CHAPTER 9

PHOSPHORYLATION OF JAK AND STAT PROTEINS FOLLOWING TYPE I INTERFERON STIMULATION IN ENDOMETRIAL CELLS

9.1 Introduction

One of the aims of this study was to determine whether Type I IFNs exert their effects through the JAK/STAT pathway in cultured human endometrial cells.

Experiments were carried out to investigate the stimulation of the JAK/STAT pathway in human endometrial cells in response to the Type I IFNs, IFNs α , β and τ .

To examine Type I IFN-induced phosphorylation of the JAK and STAT proteins, primary human endometrial cells were exposed to IFNs α , β and τ for 15 minutes. The cells were lysed and the proteins of interest, JAK1, Tyk2, STAT1 and STAT2, were immunoprecipitated with specific antibodies. The proteins underwent SDS-PAGE and Western blotting followed by incubation with antibodies to phosphotyrosine. The membranes were visualised by autoradiography and ECL chemiluminescence.

9.2 Methods

Endometrial cells were grown to confluency in 175 cm² flasks. The medium was discarded and replaced with either 10 ml of fresh fully supplemented medium containing IFN (α , β or τ) at a concentration of 1000 units per ml of medium or 10 ml of medium not containing IFN which acted as the control. The flasks were returned to the 37°C incubator for 15 min after which time the medium was discarded and the cells washed with ice-cold PBS with 1% BSA (w/v). The cells were lysed and transferred to vials and then the proteins of interest were immunoprecipitated using specific antisera as previously described in section 8.2.1. The proteins then underwent SDS-PAGE and Western blotting as described in sections 8.2.2 and 8.2.3. The PVDF membrane was then incubated overnight at 4°C with a solution containing

two monoclonal antibodies to phosphotyrosine (PY20 and 4G10) at a dilution of 1 in 2000 in TBST + 1% BSA + 0.01% NaN₃. These antibodies targeted those immunoprecipitated proteins which had been phosphorylated in response to IFN stimulation. Visualisation was carried out as previously described in section 8.2.4 using an ECL kit.

9.3 Results

Autoradiographs of the experiments using anti-phosphotyrosine antibodies show that all the protein lanes show an extra 2 bands present at molecular weights of approximately 50 kDa and 25 kDa (Figure 9.1). These bands are equivalent to the heavy and light chains of immunoglobulin (Kunisada et al 1996) and will not be shown in subsequent figures.

9.3.1 Phosphorylation status of JAK and STAT proteins in unstimulated endometrial cells.

Throughout the following experiments control lanes (cell lysates not stimulated by IFN) show that JAK1, Tyk2 and STAT2 are not present in endometrial cell lysates in a phosphorylated form prior to stimulation. However, it does appear that STAT1 α is present in endometrial cell lysates in a phosphorylated form prior to IFN stimulation (Figure 9.1).

9.3.2 Stimulation by IFN α

In response to 1000 units of IFN α , endometrial cell lysates show a relative increase in STAT1 α phosphorylation compared with the control together with phosphorylation of Tyk2 and STAT2.

There is no phosphorylation of JAK1.

Figure 9.1 Probing with anti-phosphotyrosine antibody shows STAT1 α is present in unstimulated endometrial cells constitutively phosphorylated. Immunoglobulin (Ig) heavy and light chains are also shown.

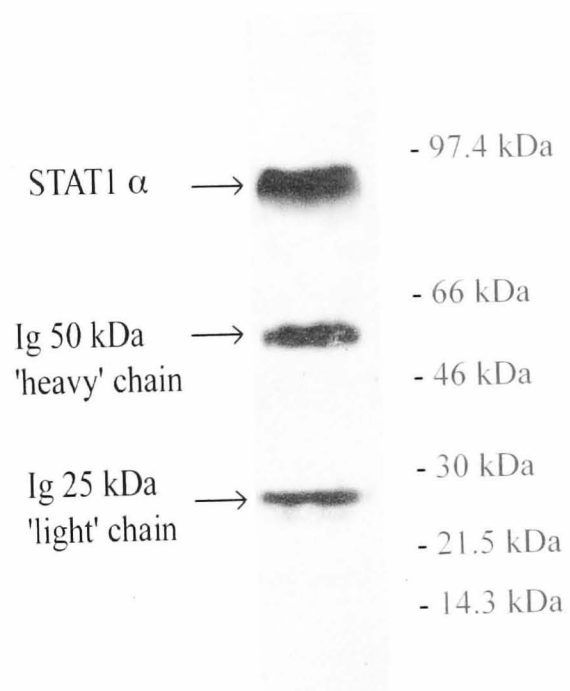

Both the 113 kDa and 84 kDa bands of STAT2 protein seen in endometrial cell lysate are phosphorylated on stimulation with IFN α . However, the 113 kDa STAT2 protein appears to be phosphorylated to a greater extent than the 84 kDa form (Figure 9.2A).

9.3.3 Stimulation by IFN β

In response to stimulation with 1000 units of IFN β endometrial cell lysates show phosphorylation of Tyk2, both the 113 kDa and 84 kDa bands of STAT2 and a marked increase in phosphorylation of STAT1 α .

JAK1 remains unphosphorylated after stimulation with IFN β .

Interestingly, in contrast to the phosphorylation pattern of STAT2 after stimulation by IFN α , IFN β phosphorylates both the 113 and 84 kDa forms to the same extent (Figure 9.2B).

9.3.4 Stimulation by IFN τ

Following stimulation with 1000 units of IFN τ endometrial cell lysates shows phosphorylation of Tyk2, no phosphorylation of STAT1 α and, in contrast to IFN α and IFN β , no phosphorylation of either of the two bands of STAT2.

Stimulation by a IFN τ fails to produce phosphorylation of JAK1.

However, the pattern of phosphorylation of STAT1 α is different to that seen in the unstimulated control and after stimulation with IFN α and β in that there appears to be de-phosphorylation of STAT1 α (Fig 9.2C).

In summary, in human endometrial cell lysates:

- IFN α , IFN β and IFN τ all stimulate the phosphorylation of Tyk2.
- Only IFN α and β activate the phosphorylation of STAT2.

- Only IFN α and IFN β stimulated an increase in phosphorylation of STAT1 α . however, in contrast, in response to IFN τ there was de-phosphorylation of STAT1 α .
- There is no phosphorylation of JAK1 by any of the Type I IFNs.

Table 9.1 The results of the stimulation of endometrial cell lysates by Type I IFNs are summarised in the following table:

	JAK1	Tyk2	STAT1 α	STAT2
control	-	-	++	-
IFN α	-	+	+++	++
IFN β	-	+	++++	++
IFN τ	-	++	-	-

Figure 9.2 Phosphorylation of JAK1, Tyk2, STAT1 α and STAT2 in endometrial cell lysates after stimulation with (A) IFN α , (B) IFN β and (C) IFN τ .

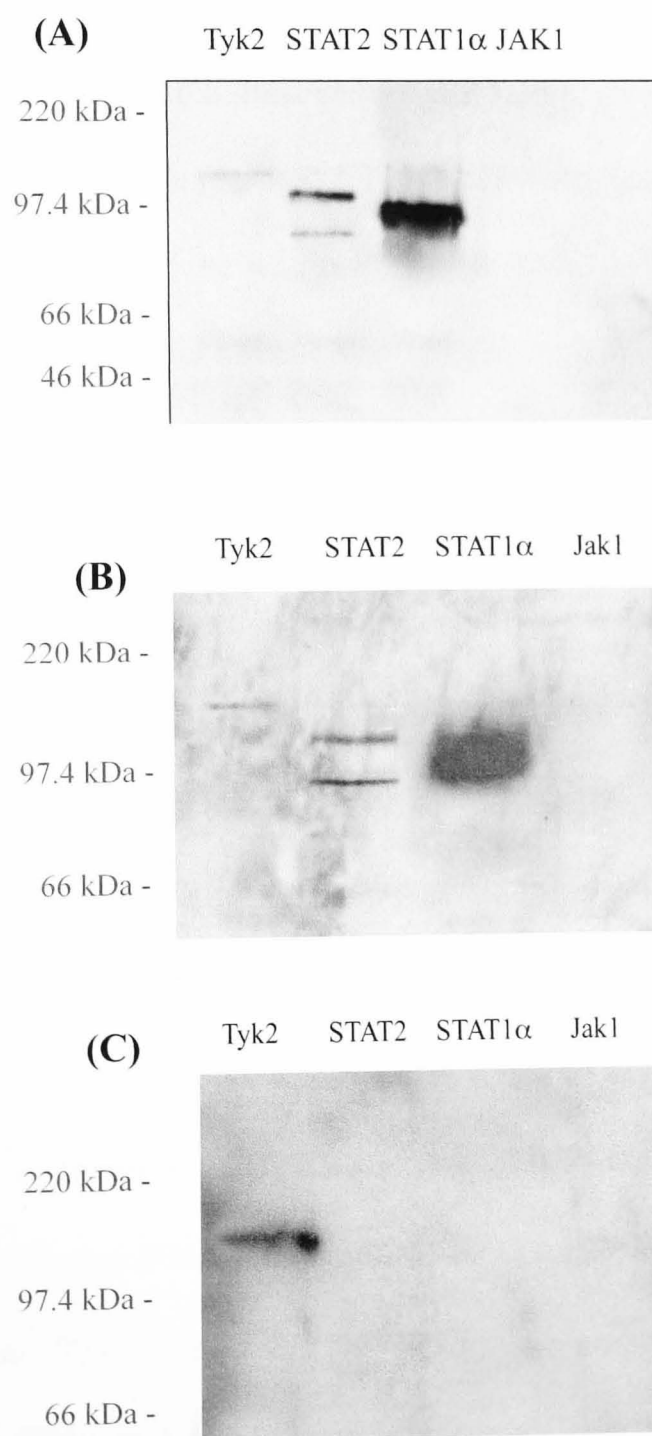

9.4 Discussion

These experiments show for the first time that Type I IFNs stimulate phosphorylation of the JAK and STAT proteins in primary human endometrial cells *in vitro*. The degree to which these proteins are phosphorylated varies depending upon which Type I IFN is used to stimulate the cells. However, none of the Type I IFNs are associated with phosphorylation of JAK1.

Despite extensive searching of the literature I have been unable to find any other studies of Type I IFN signalling in human endometrial cells.

As previously described, JAK1 is required for signalling through both the Type I and Type II IFN receptors. However, the results show that JAK1 is not phosphorylated in response to Type I IFN stimulation in endometrial cells even though the protein is present in the cell lysates. However, there is phosphorylation of Tyk2 which is necessary for IFN α/β signalling (Velasquez et al 1992 and Muller et al 1993).

In the experiments in this study there appears to be phosphorylation of STAT2 and an increase in phosphorylation of STAT1 α when cells are stimulated with IFNs α and β even in the absence of JAK1 phosphorylation. IFN τ phosphorylates Tyk2 but not JAK1 but, in contrast to IFNs α and β , there is no phosphorylation of the STAT proteins 1 α and 2. These observations suggest a complex regulation of components involved in intracellular signalling via IFN-Type I receptor.

There is constitutive association of Tyk2 with the IFNAR1 subunit of the IFN α/β receptor and JAK1 with the IFNAR2 subunit (Novick et al 1994 Abramovich et al 1994; Colamonici et al 1994).

As previously stated IFN α and IFN τ have approximately 70% sequence homology (Stewart et al 1987; Imakawa et al 1987) and they share a common receptor in the

bovine endometrium (Li and Roberts 1994). The Type I IFN receptor is highly conserved across species; the ovine and bovine Type I IFN receptors sharing 80% and 95% homology with the human IFNAR1 (Kaluz et al 1996). It appears from the results obtained in our studies that IFN τ binds to the IFN α/β receptor on human endometrial cells and this interaction stimulates the phosphorylation of Tyk2 and phosphoinositide turnover. It has been stated that IFN τ interacts with the IFNAR1 subunit of the receptor and it is known that the IFNAR1 subunit is constitutively associated with Tyk2. Thus, the response observed in these studies with IFN τ is consistent with what is known about Type I IFN signalling in that with only one receptor-associated kinase being phosphorylated there is no down-stream phosphorylation of STAT1 α and STAT2. However, the results for IFN α and β are inconsistent with this because although there is phosphorylation of Tyk2 but no phosphorylation of JAK1 there is still phosphorylation of the STAT proteins. These results are similar to those found by Grumbach and colleagues who found that human myocardial fibroblasts did not show activation of JAK1 in response to IFN α although there was some degree of activation of STAT1 (Grumbach et al 1999).

However, there may be many reasons for the lack of JAK1 phosphorylation following IFN stimulation. It is possible that our method of detection was not sensitive enough to detect phosphorylated JAK1. However, the method is perfectly adequate for detecting Tyk2, STAT1 α and STAT2. Also, the native proteins are found in endometrial cell lysates in similar quantities (Fig 8.2).

It may be possible that the anti-phosphotyrosine antibodies used in our study are not recognising the JAK1 phosphotyrosine. However, many groups use the same anti-

phosphotyrosine antibody and phosphorylated JAK1 can be detected (O'Brien et al 2002; Binelli et al 2001).

Cross-competition by different receptors for the same cellular component may be occurring. Class I and II cytokine receptors emerged in evolution after the tyrosine kinase receptors (Ruvkun and Hobert 1998). To date over 40 distinct members of these receptor families have been described but, in contrast, there are only four JAKs. Consequently, different cytokine receptor complexes share common JAK family members (Dondi et al 2001). Therefore, if receptor numbers exceed the amount of available JAK there would be competition for this component. Dondi and colleagues (2001) have shown that there is down-modulation of Type I IFN responses by receptor cross-competition for a share of JAK kinase. It is possible that this mechanism may explain the lack of JAK1 phosphorylation seen in this study when endometrial cells are exposed to Type I IFNs.

It is possible that JAK1 phosphorylation is not seen in response to IFNs α and β because, like IFN τ , IFNs α and β are only binding to the IFNAR1 subunit of the receptor and therefore in response to activation there is only phosphorylation of Tyk2, the kinase which is associated with the IFNAR1 subunit.

Finally, it is possible that the experiments carried out in this study show that JAK1 phosphorylation is not a pre-requisite for activation of the JAK/STAT pathway by Type I IFNs in human endometrial cells.

In our study it appears that the STAT1 α protein is present in endometrial cells in a phosphorylated form prior to stimulation by the Type I IFNs, in other words, STAT1 α is constitutively activated. The phenomenon of constitutive activation of the STAT proteins, including STAT1, has been demonstrated by other groups, for example, in acute myelogenous leukaemia (AML) cell lines, breast carcinoma cells, T cells,

peripheral blood cells and B lymphocytes (Speikermann et al 2001; Garcia et al 1997; Migone et al 1995; Gouilleux et al 1996; Franks et al 1997). Interestingly, Speikermann and colleagues could not detect tyrosine phosphorylation of JAK1. It could be argued that AML cell lines differ significantly in their biological and genetic characteristics from primary cells. However, constitutive activation of STAT proteins, including STAT1, has been described in primary AML and erythroleukaemia cells indicating that this observation is not an artefact of continuous cultivation or selection (Grouilleux et al 1996; Hayakawa et al 1998; Kirito et al 2002).

The mechanism of constitutive activation of the STAT proteins is not fully understood. The lack of phosphorylation of the JAK1 kinase seen in our experiments and those of Speikermann and colleagues is a confounding observation. It is possible that due to the short-lasting tyrosine phosphorylation of the JAKs after ligand binding (Speikermann et al 2001), phosphorylation of the JAK1 may not be detectable in our experiments. However, in our experiments the receptor is exposed to the ligand for 15 minutes and therefore it would be expected that as a result of continuous ligand-receptor binding there would be continuous phosphorylation. It would be expected that if JAK1 was rapidly de-phosphorylated then Tyk2 would behave in the same way but Tyk2 remains phosphorylated.

Another proposal for the mechanism of constitutive phosphorylation of the STAT proteins is the autocrine production of cytokines, for example, IL6. IL6 has been shown to cause constitutive activation of STAT1, STAT3 and STAT5 in a variety of cell types (Gerhartz et al 1996; Schuringa et al 2000; Mizuki et al 2000). The work carried out in this thesis has shown that human endometrial cells taken from both the proliferative and secretory phases of the menstrual cycle produce large quantities of IL6 (see Section 4.4.2). The proposal that autocrine IL6 production may be

responsible for constitutive STAT1 activation would be consistent with the results presented here. In addition, there is evidence from chemical cross-linking experiments, that gp130, the signal transducer for the IL6 family of cytokines, exists in close proximity to the IFNAR1 sub-unit of the IFN α / β receptor which is necessary for effective IL6 signalling by providing 'docking sites' for STAT1 and STAT3 (Mitani et al 2001). This data would help to reinforce the hypothesis that the constitutive phosphorylation of STAT1 seen in this study may be due to the autocrine production of IL6.

To investigate if constitutive activation of STAT proteins might contribute to the autonomous proliferation of AML cells Spiekermann and colleagues carried out inhibitor experiments which showed that there was a dose-dependent growth arrest. Therefore, it is possible that the proliferative nature of endometrial cells may be as a result of constitutive activation of STAT1.

However, although autocrine IL6 production may go some way towards explaining the presence of phosphorylated STAT1 α prior to stimulation with Type I interferons, it does not explain the increase in phosphorylation of STAT1 α observed in response to stimulation by IFN α and β .

There is recent evidence that, in addition to tyrosine phosphorylation, there is serine phosphorylation which is required for the transcriptional properties of STAT1 (Uddin et al 2002b). It has been shown that STAT1 is phosphorylated on serine during binding of IFN α to the Type I IFN receptor (Uddin et al 2002a; Su and David 2000). It has been demonstrated that a member of the PKC family of proteins may be involved (Uddin et al 2002a). The possibility that it is the activation of a PKC by diacylglycerol, a known activator of PKC and a product of phospholipid turnover,

which phosphorylates the serine in STAT1 in response to stimulation by IFN α and β . This is discussed further in Chapter 10, Section 10.3.

The STAT2 protein (p113) has been shown in this study to appear as a single protein band in both U3C and U4C cell lines. However, in endometrial cell lysates there appeared a second band of protein at approximately 80-90 kDa. Using a Ferguson plot of \log_{10} molecular weight against distance migrated by the molecular weight standards produced a linear relationship (Fig 9.7). The resulting linear regression equation was used to estimate a more accurate molecular weight for the lower molecular weight band of STAT2 (estimated at 84 kDa). Both the 113 kDa and the 84 kDa band became phosphorylated in response to IFNs α and β .

Sugiyama and colleagues identified alternatively spliced forms of STAT2 in human and mouse mRNAs (Sugiyama et al 1996). They found that in the human short form of STAT2, 231 C-terminal amino acid residues were replaced by novel 32 amino acids. The fragment of 231 amino acids represents 27% of the total protein and this is replaced by 32 amino acids which are 3.8% of the full length protein. Therefore, it follows that the short form would have a molecular weight of approximately 87 kDa. This is very close to the estimated weight of 84 kDa calculated for the lower molecular weight band of STAT2 seen in endometrial cell lysates.

This band may be evidence for the existence of the spliced form of STAT2 in human endometrial cells.

The results obtained suggest that selective activation of the JAK/STAT proteins may account for the occurrence of differences in the properties of distinct Type I IFNs in certain cell types.

CHAPTER 10
SUMMARY AND
GENERAL DISCUSSION

10.1 Objectives of this thesis

The principle purpose of this study was to test the hypothesis that although Type I interferons activate a common tyrosine kinase signalling pathway in the human endometrium there is simultaneous activation of different phospholipase pathways which confer the specificity of the IFN response.

However, in order to carry out the work it was necessary to establish the following:

- 1) long-term primary human endometrial cell culture
- 2) that primary human endometrial cells possess a functional IFN α/β receptor
- 3) that phospholipid turnover occurs in endometrial cells in response to Type I IFNs and the identity of the phospholipids involved
- 4) the presence of the JAK/STAT proteins in primary human endometrial cells in culture
- 5) that there was phosphorylation of the JAK/STAT proteins in response to Type I IFNs.

10.2 Summary of principle findings

10.2.1 Primary human endometrial cell culture

The use of primary human endometrial cells for experimental study is common place. However, the vast majority of studies use short term culture using cells within several days of the initial seeding out. To be able to study the effects of Type I interferon stimulation on phospholipid turnover and JAK/STAT phosphorylation it was necessary to culture the cells long enough to allow consecutive experiments on the same material to be carried out thus maintaining experimental consistency. For long-term endometrial cell culture it has been common practice to use cell lines which

have the major disadvantage of not being representative of cells *in vivo*. By measuring PP14 and IGFBP-1, markers of endometrial function and cell morphology, we have shown that primary human endometrial cells can be cultured for up to 15 days whilst maintaining features characteristic of their cell type and phase of the menstrual cycle.

The cells also produced cytokines LIF, IL-6 and HGF in accordance with published data on endometrial cell cytokine production. However, in contrast to the findings of other groups, we have demonstrated for the first time that HGF is produced by primary human endometrial cells in both the proliferative and secretory phases of the menstrual cycle. In response to the lack of data on the production of IFN γ by endometrial cells *in vitro* we examined IFN γ production by a mixed population of endometrial cells from both the proliferative and secretory phases of the menstrual cycle and found that IFN γ was undetectable in all cases. With an established endometrial cell material we were able to continue with the objectives laid out in the thesis.

10.2.2 IFN α/β receptor

Before embarking on a series of experiments looking at phospholipid turnover and phosphorylation of JAK and STAT proteins in endometrial cells in response to type I IFNs it was important to establish that primary human endometrial cells in culture respond to Type I IFNs in other words they possess a functional receptor. We found both direct and indirect evidence for a functioning receptor. Radiolabelled IFN α showed binding to endometrial cells *in vitro* and immunohistochemistry using mono- and polyclonal antibodies to the receptor localised it further to both the stromal and

epithelial cells in endometrial tissue from both the proliferative and secretory phases of the menstrual cycle. These results provided evidence for the IFN α/β receptor being present on endometrial cells.

In addition, endometrial cells from both phases of the menstrual cycle showed an anti-proliferative response to IFN α and thus demonstrated that the endometrial IFN α/β cell receptor functions *in vitro*.

10.2.3 Phospholipid turnover in endometrial cells in response to Type I IFN stimulation

Having established long-term cell culture of human endometrium and the presence of a functioning IFN α/β receptor it was possible to investigate the pattern of phospholipid turnover in response to the Type I IFNs.

It is well recognised that Type I IFNs on binding to the IFN α/β receptor result in the activation of the receptor-associated JAK1 and Tyk2 kinases which regulate phosphorylation of multiple signal elements and the engagement of several downstream pathways including the STAT, the IRS-PI3'-kinase, the Crk and the mitogen-activated protein (MAP) kinase pathways (Uddin S et al 2002b).

However, the experiments carried out in this study have shown for the first time that Type I IFNs will, in human endometrial cells, stimulate a pathway involving phospholipid second messengers. Interestingly, phospholipid turnover is activated by both IFNs α and τ but, in contrast, IFN β does not appear to elicit a phospholipid turnover response. Other groups, using Daudi and HeLa cells (Cataldi et al 1990; Pfeffer et al 1990), reported production of DAG in response to IFN α but the work carried out for this thesis has demonstrated for the first time that IFN α not only

activates production of DAG but the hydrolysis of the phosphoinositides PIP₂, PIP and PA.

To date there is no published data on the activation of phospholipid mechanisms by IFN τ in any cell type. However, we can report that IFN τ stimulates hydrolysis of PIP₂ and PIP with concurrent production of DAG in human endometrial cells *in vitro*.

10.2.4 JAK and STAT proteins in endometrial cells and their phosphorylation following Type I IFN stimulation

Having established the presence of the unphosphorylated JAK1, Tyk2, STAT1 α and STAT2 proteins in human endometrial cells it was possible to determine if there was phosphorylation of these elements in endometrial cells in response to stimulation by Type I IFNs. We have shown that both IFN α and β will activate the phosphorylation of Tyk2, STAT1 α and STAT2. However, in contrast IFN τ does not stimulate the phosphorylation of STAT2 or STAT1 α . Moreover, none of the IFN isotypes used in the experiments activated the phosphorylation of JAK1.

General Discussion

In summary, we have shown that:

- 1) Type I interferons α , β and τ elicit a signal transduction response in cultured human endometrial cells
- 2) Type I interferons activated both the phospholipase and JAK/STAT pathways
- 3) the nature of the response appears to differ depending upon which interferon is used to stimulate the cells.

The results show that IFN α stimulates hydrolysis of PIP₂ with the production of the metabolite diacylglycerol in human endometrial cells. These findings agree with other workers who found that the interaction of IFN α with several cells types, including human fibroblasts and Daudi cells, stimulates the release of DAG and inositol phosphates (Pfeffer et al 1990; Yap et al 1986). This is due to activation of phosphoinositide-specific phospholipase C (Popescu et al 1989) and it has been suggested that this activation is the initial step in the interferon α induced transmembrane signalling pathway in these cells.

Interferon τ , like IFN α , induces hydrolysis of PIP₂ but it also induces hydrolysis of PIP and a reduction of PI levels over a period of 2 minutes after stimulation. However, in contrast, IFN τ appears to have a more limited effect on the JAK/STAT pathway with phosphorylation of Tyk2 only.

Interferon β does not stimulate hydrolysis of any of the phosphoinositides nor does it stimulate production of DAG, but, in stark contrast to these findings, it does stimulate strong phosphorylation of Tyk2, STAT1 α and STAT2.

JAK1, on the other hand, is not phosphorylated after stimulation by any of the Type I IFNs. This finding is at odds with published data as it is known that JAK1 is required for the assembly of the IFN α/β receptor leading to the activation of the JAK and STAT proteins (see Chapter 8).

It has been established that the JAK/STAT pathway plays a critical role in interferon-dependent gene regulation and that one of the most important steps in this signalling

mechanism is the association of the JAKs with the receptor and their subsequent regulation of the tyrosine phosphorylation of the STAT proteins. The STAT protein complexes that are formed as a consequence translocate to the nucleus to initiate gene transcription by binding to distinct elements in the promoters of IFN-activated genes. However, the picture that has emerged from the work carried out in this thesis is that there appears to be phosphorylation of the STAT proteins without any phosphorylation of the JAK1 kinase. Since we have shown that IFN α exhibits an anti-proliferative effect on human endometrial cells *in vitro* it would appear that the phosphorylation of the STAT proteins leads to a functional response without the requirement of JAK1 phosphorylation. There is strong evidence that, in addition to tyrosine phosphorylation, phosphorylation on serine is required for the transcriptional properties of STAT1 (Uddin et al 2002b). STAT1 has a phosphorylation site on its C terminus serine 727. The functional relevance of serine phosphorylation of STAT1 has been demonstrated in studies performed in the Type II IFN system in which it was shown that complementation of STAT1-deficient cells with a Ser-727 mutant fails to restore induction of the antiproliferative and antiviral properties of IFN γ whereas re-expression of the wild type restores the deficiencies. However, there is evidence that STAT1 is also phosphorylated on serine during engagement of the Type I IFN receptor with IFN α (Uddin et al 2002a; Su and David 2000) suggesting a role for serine phosphorylation of STAT1 in the generation of Type I interferon responses. The mechanisms regulating Type I IFN-inducible phosphorylation of STAT1 on serine 727 have not been elucidated. The serine kinase regulating such phosphorylation remains unknown although it had been thought that p38 MAP kinase would be a good candidate but extensive studies by Uddin and colleagues (Uddin et al

2002a) established that it does not function as a serine kinase for STAT1 phosphorylation. Uddin and colleagues have demonstrated that a member of the PKC family of proteins, PKC- δ , is phosphorylated during binding of the Type I IFN receptor by IFN α and that its kinase domain is induced (Uddin et al 2002b). With this information it is possible to suggest that in our experiments IFN α/β receptor binding on endometrial cells leading to antiproliferative activity, in the absence of JAK1 phosphorylation but the presence of STAT1 phosphorylation, can be explained by serine phosphorylation of STAT1 instead of tyrosine phosphorylation of STAT1. However, the question arises is how does the STAT1 serine become phosphorylated? It is possible that the phospholipid second messenger signalling pathway may give an answer. In this study it has been shown that in response to IFN α stimulation there is hydrolysis of phospholipids with a concurrent production of DAG. Diacylglycerol is an activator of PKC (Nishizuka 1988) and it is known that a Type I IFN, IFN τ , activates PKC in MDBK cells (Commander et al 1993). Therefore, it could be proposed that it is the production of DAG in response to IFN α stimulation that leads to the activation of PKC which may, in turn, be responsible for the serine phosphorylation of STAT1. These results suggest the existence of a cross-talk mechanism by which PKC participates in co-operation with JAK/STAT signalling pathway to regulate Type I IFN-dependent responses. The PKC element being generated by the phospholipid second messenger DAG as a product of phospholipid hydrolysis by IFN α activation. Guanosine triphosphate (GTP) is necessary for the IP₃ and DAG signalling mechanism (Haslam & Davidson 1984; Gomperts & Cockcroft 1985) with the G protein coupling the surface receptor to the enzyme phospholipase C (PLC) which then cleaves the PIP₂ into IP₃ and DAG. However, to

have cross-talk between signalling pathways it would be expected that the JAK/STAT and the phospholipid pathways would be activated simultaneously upon ligand-receptor binding. Therefore, it would be important to have close association of the G protein with the Type I IFN receptor and Mitani and colleagues (2001) have shown, using chemical cross-linking experiments, that the IFNAR1 subunit does exist in close proximity with the G protein gp130. It has also been shown that other cytokines activate a signalling pathway through a G protein. Leukaemia inhibitory factor, (LIF), will activate the JAK and STAT pathway through gp130 in cardiac myocytes (Kunisada et al 1996).

However, IFN τ appears to behave differently from IFN α . In our studies, IFN τ , like IFN α , activates the generation of phospholipid second messengers with the production of DAG. It is therefore possible that as a result of the production of DAG there will be activation of PKC. Although there is phosphorylation of Tyk2, through the binding of the IFNAR1 subunit of the receptor, there is no observed phosphorylation of either STAT1 or STAT2 in response to IFN τ stimulation. The lack of STAT1 phosphorylation would cast doubt on the suggestion that it may be a PKC which phosphorylates the STAT1 serine 727. However, IFN α binding to the Type I interferon receptor on human endometrial cells stimulates the hydrolysis of PA within 2 seconds of exposure and that these levels remain significantly reduced even at 1 minute ($p = 0.01$) suggesting that PA turnover may also be involved. In contrast, there is no hydrolysis of PA in response to IFN τ stimulation. Interestingly, PA can be hydrolysed by the enzyme phosphatidic acid phosphohydrolase to form DAG. It is therefore possible that the DAG seen after IFN α stimulation may be derived not only

from PIP2 hydrolysis but also from PA hydrolysis. This additional DAG may be sufficient to activate PKC on IFN α stimulation leading to serine phosphorylation of STAT1. However, since PA is not involved in the response to IFN τ stimulation, the only source of DAG is from PIP2 hydrolysis. Therefore, it is possible that the amount of DAG produced by PIP2 hydrolysis alone may not be sufficient to activate PKC and this may explain the absence of STAT1 phosphorylation in response to IFN τ stimulation.

10.4 Future directions

To determine whether there is a relationship between the JAK/STAT and phospholipid signalling pathways it would be necessary to establish if 1) the Type I IFN binding with the receptor activates the JAK/STAT and phospholipid pathways independently of one another and 2) phospholipid turnover and second messenger generation is a prerequisite for the activation of the tyrosine kinases and/or STAT proteins.

To address the question do the JAK/STAT and phospholipid pathways signal independently it would be necessary to look at the activation of the JAK/STAT proteins in the presence of phospholipase inhibitors and phospholipid turnover in the presence of the tyrosine kinase inhibitors. Phospholipase inhibitors include aristolochic acid, 4-(4-octadecyl)-4-oxobenzenebutenoic acid (OBAA) for A2 and 7,7-dimethyl-5,8-eicosadienoic acid (DEDA) which is a potent inhibitor of recombinant human placental phospholipase A2; tricyclodecan-9-yl xanthogenate (D609) for C; neomycin sulphate for C and D and D,L-erythrodihydrosphingosine for

A2 and D. Inhibitors of tyrosine kinase include genistein, tyrphostins, lavendustin A and herbimycin A.

The effect of second messengers generated from phospholipid turnover on JAK/STAT activation following exposure to IFN can be investigated using inhibitors of PKC (calphostin C, chelerythrine chloride), cyclooxygenase and lipoxygenase inhibitors (indomethacin, salicylic acid) and intracellular calcium chelators (1,2-bis(2-aminophenoxy)ethane-N,N,N',N'-tetraacetic acid (BAPTA)). However, if no effect is found on the JAK/STAT proteins in the presence of phospholipase inhibitors this does not rule out the possibility that phospholipid turnover may exert an effect further downstream.

It would be interesting to establish if, in the absence of IFN stimulation, there would be activation of the JAK/STAT pathway and the formation of ISGF3 in endometrial cells incubated in the presence of one of the following:

- i) phospholipid-generated second messengers, for example, arachidonic acid and prostaglandins
- ii) PKC activators, for example, phorbol 12-myristate 13-acetate (PMA)
- iii) calcium ionophores, for example, ionomycin.

It is possible that the specificity of the IFN stimulated response is dependent upon modifications of ISGF3. An alteration of this complex may result in binding to a different ISRE which would consequently trigger the expression of different genes. Differences in ISGF3 complexes may arise either through activation of different subtypes of latent transcription factors or through activation of different phospholipase pathways resulting in second messenger modification. ISGF3 modifications can be determined using ³⁵S-methionine, SDS-PAGE and

autoradiography. These experiments could then be repeated in the presence of phospholipase inhibitors.

Having established that the phospholipid pathways are used by IFNs α and τ in the human system the next step would be to repeat the experiment in sheep endometrial cell culture to investigate if the pattern of phospholipid turnover differs not only between the IFN isotypes but also between species. Ovine caruncle (sheep 'endometrium') material was collected during the latter part of the work carried out in this thesis. However, the material was heavily contaminated and required increasing concentrations of antibiotics, including the use of gentamycin, to maintain uninfected cultures.

10.5 Conclusions

We have confirmed that the JAK/STAT pathway is the universal signalling mechanism used by Type I IFNs and we have shown for the first time that the Type I IFNs also activate a different signalling pathway that of phospholipid hydrolysis. We have shown that the pathways are activated differently depending on the Type I IFN isotype used.

It is hoped that the results from this study will not only shed further light on the mechanism of action of Type I IFNs in general and their function in human pregnancy but may also contribute to our understanding of the processes involved in human fetal-maternal recognition.

REFERENCES

- Aboagye-Mathieson G, Toth FD, Juhl C, Norskov-Lauritsen N, Petersen PM, Zachar V and Ebbesen P (1991) Characterisation of Sendai virus-induced human placental trophoblast interferons. *J Gen Virol* **72** 1871-1876.
- Abramovich C, Shulman LM, Ratovitski E, Harroch S, Tovey M, Eid P and Revel M (1994) Differential tyrosine phosphorylation of the IFNAR chain of the type I interferon receptor and of an associated surface protein in response to IFN α and IFN β . *EMBO J* **13** 5871-5877.
- Adolf GR (1987) Antigenic structure of human interferon ω 1 (interferon α II): comparison with other human interferons. *J Gen Virol* **68** 1669-1676.
- Adolf GR, Fruhbeis B, Hauptmann R, Kalsner I, Maurer-Fogy I, Ostermann E, Patzelt E, Schwendenwein R, Sommergruber W and Zophel A (1991) Human interferon ω 1: Isolation of the gene, expression in Chinese hamster ovary cells and characterisation of recombinant protein. *Biochim Biophys Acta* **1089** 167-174.
- Aguet M (1980) High-affinity binding of 125 I-labelled mouse interferon to a specific cell surface receptor. *Nature* **284** 459-461.
- Anthony RV, Helmer SD, Sharif SF, Roberts RM, Hansen PJ, Thatcher WW and Bazer FW (1988) Synthesis and processing of ovine trophoblast protein-1 and bovine trophoblast protein-1, conceptus secretory proteins involved in the maternal recognition of pregnancy. *Endocrinology* **123** 1274-1280.

Arai, KI, Lee F, Miyajima A, Miatake S, Arai N and Yokota T (1990) Cytokines: co-ordination of immune and inflammatory responses. *Ann Rev Biochem* **59** 783-836.

Barlow DP, Randle BJ and Burke DC (1984) Interferon synthesis in the early post-implantation mouse embryo. *Differentiation* **27** 229-235.

Bartol FF, Roberts RM, Bazer FW, Lewis GS, Godkin JD and Thatcher WW (1985) Characterisation of proteins produced *in vitro* by peri-attachment bovine conceptuses. *Biol Reprod* **32** 681-693.

Bell SC, Jackson JA, Ashmore J, Zhu HH and Tseng L (1991) Regulation of insulin-like growth factor binding protein-1 synthesis and secretion by progestin and relaxin in long term cultures of human endometrial stromal cells. *J Clin Endocrinol Metab* **72** 1014-1024.

Bergqvist A, Nejaty H, Froysa B, Bruse C, Carlberg M, Sjoblom P and Soder O (2000) Production of interleukins 1 β , 6 and 8 and tumour necrosis factor α in separated and cultured endometrial and endometriotic stromal and epithelial cells. *Gynecol Obstet Invest* **50** 1-6.

Berridge MJ (1991) The molecular basis of communication within the cell. In: Rasmussen H (Ed), *Cell communication in health and disease*. Freeman & Co, New York, 37-50.

Berridge MJ (1993) Inositol triphosphate and calcium signalling. *Nature* **361** 315-325.

Berridge MJ and Irvine RF (1984) Inositol triphosphate, a novel second messenger in cellular signal transduction. *Nature* **312** 315-321.

Bersinger NA, Brandenberger AW, Zakher A, Dreher E, Altermatt HJ and Birkhauser MH (1995) Production of endometrial placental protein 14 and prolactin by cultured endometrial explants after collagenase and freeze/thaw treatment and in response to progesterone. *Early Pregnancy* **1** 134-140.

Bhatt H, Brunet LJ, and Stewart CL (1991) Uterine expression of leukaemia inhibitory factor coincides with the onset of blastocyst implantation. *Proc Natl Acad Sci USA* **88** 11048-11053.

Binelli M, Subramaniam P, Diaz T, Johnson GA, Hansen TR, Badinga L and Thatcher WW (2001) Bovine interferon- τ stimulates the Janus kinase-signal transducer and activator of transcription pathway in bovine endometrial epithelial cells. *Biol Reprod* **64** 654-665.

Bligh EG and Dyer WJ (1959) A rapid method of total lipid extraction and purification. *Can J Biochem Physiol* **37** 911-917.

Bocci V, Paulesu L and Ricci MG (1985) The physiological interferon response: Production of interferon by the perfused human placenta at term. *Proc Soc Exp Biol Med* **180** 137-143.

Bohn H, Kraus W and Winckler W (1982) New soluble placental tissue proteins: their isolation, characterisation, localisation and quantification. In: Klopper A (Ed), *Immunology of human placental proteins*. Praeger, New York, 67-82.

Bolton AE, Chapman MG, Stoker RJ, Andrew CE, Wass D and Bohn H (1983) The radioimmunoassay of placental protein 14 (PP14). *Clin Chim Acta* **135** 283-291.

Bolton AE, Pockley AG, Clough KJ, Mowles EA, Stoker RJ, Westwood OMR and Chapman MG (1987) Identification of placental protein 14 as an immunosuppressive factor in human reproduction. *Lancet* **i** 593-595.

Borri P, Noci I, Fuzzi B, Rice A and Chard T (1998) The ovary is not a major source of placental protein 14 (glycodelin). *Human Reprod* **13** 3418-3420.

Branca AA and Baglioni C (1981) Evidence that type I and II interferons have different receptors. *Nature* **294** 768-770.

Briscoe J, Guschin D and Muller M (1994) Just another signalling pathway. *Curr Biol* **4** 1033-1035.

Bulmer JN, Morrison L, Johnson PM and Meager E (1990) Immunohistochemical localisation of interferons in human placental tissues in normal, ectopic and molar pregnancy. *Am J Immunol* **22** 109-116.

Byrjalsen I, Larsen PM, Fey SJ, Thormann L, Pedersen BJ and Christiansen C (1995) Two-dimensional gel analysis of human endometrial proteins: cyclic changes in the expression of specific proteins during the normal menstrual cycle. *Hum Reprod* **10** 13-18.

Callard R and Gearing A (1994) *The Cytokine facts book*. The Factsbook series. Academic Press: London, p 151.

Cantell K and Hirvonen S (1977) Preparation of human leukocyte interferon for clinical use. *Tex Rep Biol Med* **35** 138-144.

Capon DJ, Shepard HM and Goeddes DV (1985) Two distinct families of human and bovine interferon α genes are co-ordinately expressed and encode functional polypeptides. *Mol Cell Biol* **5** 768-779.

Cataldi A, Miscia S, Lisio R, Rana R and Cocco L (1990) Transient shift of diacylglycerol and inositol lipids induced by interferon in Daudi cells. *FEBS Lett* **269** 465-468.

Cataldi A, Di Primio R, Lisio R, Rana RA, Robuffo I, Bosco D and Miscia S (1993) Inositol lipid-mediated intranuclear signalling: a comparative analysis of in vivo labelling in interferon α -sensitive and α -resistant Daudi lymphoma cells. *Cell Signal* **5** 331-336.

Cataldi A, Caracino A, Di Baldassarre A, Robuffo I and Miscia S (1995) Interferon β mediated intracellular signalling traffic in human lymphocytes. *Cell Signal* **7** 627-633.

Challis JR, Lye SJ and Gibb W (1997) Prostaglandins and parturition. *Ann N Y Acad Sci* **828** 254-267.

Chatzaki E, Gallagher CJ, Iles RK, Ind TEJ, Nouri AME, Bax CMR and Grudzinskas JG (1994) Characterisation of the differential expression of marker antigens by normal and malignant endometrial epithelium. *Br J Cancer* **69** 1010-1014.

Chard T, Craig PH, Menabawey M and Lee C (1986) α interferon in human pregnancy. *Br J Obstet Gynaecol* **93** 1145-1149.

Chard T and Iles R (1992) Interferon as a fetoplacental signal in pregnancy. *Trophoblast Research* **6** 55-72.

Chen DB, Hilsenrath R, Yang ZM, Le SP, Kim SR, Chuong CJ, Poindexter III AN and Harper MJK (1995) Leukaemia inhibitory factor in human endometrium during the menstrual cycle: cellular origin and action on production of glandular epithelial cell prostaglandin *in vitro*. *Human Reprod* **10** 911-918.

Chiang CM and Hill JA (1997) Localization of T cells, interferon γ and HLA-DR in eutopic and ectopic human endometrium. *Gynecol Obstet Invest* **43** 245-250.

Cockcroft S and Gomperts BD (1985) Role of guanine nucleotide binding protein in the activation of polyphosphoinositide phosphodiesterase. *Nature* **314** 534-536.

Colamonici OR, D'Alessandro F, Diaz MO, Gregory SA, Neckers LM and Nordan R (1990) Characterisation of three monoclonal antibodies that recognise the IFN α 2 receptor. *Proc Natl Acad Sci USA* **87** 7230-7234.

Colamonici OR, Pfeffer LM, D'Alessandro F, Plataniias LC, Gregory SA, Rosolen A, Nordan R, Cruciani RA and Diaz MO (1992) Multichain structure of the IFN- α receptor on hematopoietic cells. *J Immunol* **148** 2126-2132.

Colamonici O, Yan H, Domanski P, Handa R, Smalley D, Mullersman J, Witte M, Krishnan K and Krolewski J (1994) Direct binding to and tyrosine phosphorylation

of the α subunit of the type I interferon receptor by p135^{tyk2} tyrosine kinase. *Mol Cell Biol* **14** 8133-8142.

Commander H, Abayasekara DRE and Flint APF (1993) Recombinant ovine trophoblast interferon (roIFN) activates protein kinase C in MDBK cells. *J Reprod Fertil (Abstr Ser)* **10** number 22.

Coxon RE (1996) PhD thesis The production of specific antibodies to TNF α and their potential use in diagnosis and therapy.

Cross JC and Roberts RM (1989) Porcine conceptuses secrete an interferon during the pre-attachment period of early pregnancy. *Biol Reprod* **40** 1109-1118.

Cross JC and Roberts RM (1991) Constitutive and trophoblast-specific expression of a class of bovine interferon genes. *Proc Natl Acad Sci USA* **88** 3817-3821.

Danet-Desnoyers G, Wetzels G and Thatcher WW (1994) Natural and recombinant bovine interferon τ regulate basal and oxytocin-induced secretion of prostaglandins F_{2 α} and E₂ by epithelial cells and stromal cells in the endometrium. *Reprod Fertil Dev* **6** 193-202.

Darnell JE, Kerr IM and Stark GR (1994) Jak-STAT pathways and transcriptional activation in response to IFNs and other extracellular signaling proteins. *Science* **264** 1415-1421.

David M, Romero G, Zhang ZY, Dixon JE and Larner AC (1993) In vitro activation of the transcription factor ISGF3 by interferon α involves a membrane-associated tyrosine phosphatase and tyrosine kinase. *J Biol Chem* **268** 6593-6599.

Demmers KJ, Derecka K and Flint A (2001) Trophoblast interferon and pregnancy. *Reproduction* **121** 41-49.

Dondi E, Pattyn E, Lutfalla G, Van Ostade X, Uze G, Pellegrini S and Tavernier J (2001) Down-modulation of Type I interferon responses by receptor cross-competition for a shared Jak Kinase. *J Biol Chem* **276** 47004-47012.

Duc-Goiran P, Robert-Gailliot B, Chudzio T and Chany T (1983) Unusual human interferons produced by virus-infected amniotic membranes. *Proc Natl Acad Sci USA* **80** 2628-2631.

Duc-Goiran P, Robert-Gailliot B, Lopez J and Chany T (1985) Unusual apparently constitutive interferons and antagonists in human placental blood. *Proc Natl Acad Sci USA* **82** 5010-5014.

Epifanova OI (1971) Effects of hormones on the cell cycle. In: *The Cell Cycle and Cancer*. Baserga R (Ed). M Dekker, New York, 145.

Evans AT, Caradang G, Quilligan EJ and Cesario TC (1985) Interferon responses in maternal and fetal mice. *Am J Obstet Gynecol* **152** 99-102.

Farin CE, Imakawa K and Roberts RM (1989) In situ localisation of mRNA for the interferon, ovine trophoblast protein 1, during early embryonic development of the sheep. *Mol Endo* **3** 1099-1107.

Farrar MA and Schrieber RD (1993) The molecular cell biology of interferon- γ and its receptor. *Ann Rev Immunol* **11** 571-611.

Fay TN, Jacobs IJ, Teisner B, Westergaard JG and Grudzinskas JG (1990) A biochemical test for the direct assessment of endometrial function: measurement of the major secretory protein PP14 in serum during menstruation in relation to ovulation and luteal function. *Human Reprod* **5** 382-386.

Ferenczy A, Bertrand G and Gelfand MM (1979) Proliferation kinetics of the human endometrium during the normal menstrual cycle. *Am J Obstet Gynecol* **133** 859-867.

Fincher KB, Bazer FW, Hansen PJ, Thatcher WW and Roberts RM (1986) Ovine conceptus secretory proteins suppress induction of uterine prostaglandin F_{2α} release by oestradiol and oxytocin. *J Reprod Fertil* **76** 425-433.

Fleming H (1999) Structure and function of cultured endometrial epithelial cells. *Seminars in Reprod Endocrinol* **17** 93-106.

Fowler AK, Reed CD and Giron DJ (1980) Identification of an interferon in murine placentas. *Nature* **286** 266-267.

Frank DA, Mahajan S and Ritz J (1997) B lymphocytes from patients with chronic lymphocytic leukemia contain signal transducer and activator of transcription (STAT) 1 and STAT3 constitutively phosphorylated on serine residues. *J Clin Invest* **100** 3140-3148.

Freshney RI (1983) Culture of animal cells. A manual of basic technique. Alan R Liss Inc, New York.

Fukaya T, Sugawara J, Yoshida H, Murakami T and Yajima A (1999) Intercellular adhesion molecule-1 and hepatocyte growth factor in human endometriosis: original investigation and a review of literature. *Gynecol Obstet Invest* **47** suppl 1:11-6, discussion 16-17.

Garcia FU, Chen HL, Yang Y, Pace JL, Hu XL and Hunt JS (1994) Tumour necrosis factor- α mRNA and protein in endometrial tumours: analysis by *in situ* hybridisation and immunohistochemistry. *Human Pathol* **25** 1324-1331.

Garcia R, Yu CL, Hudnall A, Catlett R, Nelson KL, Smithgall T, Fujita DJ, Ethier SP and Jove R (1997) Constitutive activation of STAT3 in fibroblasts transformed by diverse oncoproteins and in breast carcinoma cells. *Cell Growth Differ* **8** 1267-1276.

Gearing DP, Gough NM, King JA, Hilton DJ, Nicola NA, Simpson RJ, Nice EC, Kelso A and Metcalf D (1987) Molecular cloning and expression of cDNA encoding a murine myeloid leukaemia inhibitory factor (LIF). *EMBO J* **6** 3995-4002.

Gerhartz C, Heesel B, Sasse J, Hemmann U, Landgraf C, Schneider-Mergener J, Horn F, Heinrich PC and Graeve L (1996) Differential activation of acute phase response factor/STAT3 and STAT1 via the cytoplasmic domain of the interleukin 6 signal transducer gp130. I. Definition of a novel phosphotyrosine motif mediating STAT1 activation. *J Biol Chem* **271** 12991-12998.

Gherardi E, Gray J, Stoker M, Perryman M and Furlong R (1989) Purification of scatter factor, a fibroblast-derived basic protein that modulates epithelial interactions and movement. *Proc Natl Acad Sci USA* **86** 5844-5848.

Gherardi E and Stoker M (1991) Hepatocyte growth factor – scatter factor: mitogen motogen and met. *Cancer Cells* **3** 227-232.

Giudice LC, Lamson G, Rosenfeld RG and Irwin JC (1991) Insulin-like growth factor-II (IGF-II) and IGF binding proteins in human endometrium. *Ann NY Acad Sci* **626** 295-307.

Giudice LC (1999) Potential biochemical markers of uterine receptivity. *Hum Reprod Suppl* **2** 3-16.

Godkin JD, Bazer FW, Moffat J, Sessions F and Roberts RM (1982) Purification and properties of a major, low molecular weight protein released by the trophoblast of sheep blastocysts at day 13-21. *J Reprod Fertil* **65** 141-150.

Godkin JD, Bazer FW and Roberts RM (1984) Ovine trophoblast protein-1, an early secreted blastocyst protein, binds specifically to uterine endometrium and affects protein synthesis. *Endocrinology* **114** 120-130.

Gonzalez-Sastro F and Folch-Pi J (1968) Thin layer chromatography of the phosphoinositides. *J Lipid Res* **9** 532-533.

Goodwin J and Ceuppens J (1983) Special article: Regulation of the immune response by prostaglandins. *J Clin Immunol* **3** 295-315.

Gouilleux-Gruart V, Gouilleux F, Desaint C, Claisse JF, Capiod JC, Delobel J, Weber-Nordt R, Dusanter-Fourt I, Dreyfus F, Groner B and Prin L (1996) STAT-related transcription factors are constitutively activated in peripheral blood cells from acute leukemia patients. *Blood* **87** 1692-1697.

Greenwood FC, Hunter WM and Glover JS (1968) The preparation of ¹³¹I labelled human growth hormone of high specific activity. *Biochem J* **89** 114-117.

Grumbach IM, Fish EN, Uddin S, Majchrzak B, Colamonici OR, Figulla HR, Heim A and Plataniias LC (1999) Activation of the Jak-Stat pathway in cells that exhibit selective sensitivity to the antiviral effects of IFN β compared with IFN α . *J Interferon Cytokine Res* **19** 797-801.

Gunn LK, Homa ST, Searle MJ and Chard T (1994) Lack of evidence for the production of interferon α -like species by the cultured human pre-embryo. *Hum Reprod* **9** 1522-1527.

Hannigan GE and Williams BRG (1991) Signal transduction by interferon α through arachidonic acid metabolism. *Science* **251** 204-207.

Hames BD (1981) An Introduction to Polyacrylamide Gel Electrophoresis. In: *Gel Electrophoresis of Proteins; a practical approach*. IRL Press Ltd, Oxford pp 1-92.

Hansen TR, Austin KJ, Perry DJ, Pru JK, Teixeira MG and Johnson GA (1999) Mechanism of action of IFN τ in the uterus during early pregnancy. *J Reprod Fertil Suppl* **54** 329-339.

Haque SJ and Williams BRG (1998) Signal transduction in the interferon system. *Semin Oncol* **25** (suppl) 14-22.

Haque SJ and Williams BRG (2001) *Cytokine Reference 2001 Vol 2 Receptors* pp1845-1854 Eds Oppenheim JJ and Feldmann MA Academic Press London.

Haslam RJ and Davidson MM (1984) Receptor-induced diacylglycerol formation in permeabilised platelets; possible role for a GTP-binding protein. *J Recept Res* **4** 605-629.

Hayakawa F, Towatari M, Iida H, Wakao H, Kiyoi H, Naoe T and Saito H (1998) Differential constitutive activation between STAT-related proteins and MAP kinase in primary acute myelogenous leukaemia. *Br J Haematol* **101** 521-528.

Helmer SD, Hansen PJ, Anthony RV, Thatcher WW, Bazer FW and Roberts RM (1987) Identification of bovine trophoblast protein-1, a secretory protein immunologically related to ovine trophoblast protein-1. *J Reprod Fertil* **79** 83-91.

Hills FA and Chard T (1995) Insulin-like growth factors and their binding proteins in the control of fetal growth. *Contemp Rev Obstet Gyneacol* **7** 197-201.

Hokin MR and Hokin LL (1953) Enzyme secretion and the incorporation of ³²P into phospholipids of pancreas slices. *Biol Chem* **203** 967-977.

Hoskins M (1935) A protective action of neurotropic against viserotropic yellow fever virus in *Macacus rhesus*. *Am J Trop Med Hyg* **15** 675-680.

Howatson AG, Farquharson M, Meager A, McNicol AM and Foulis AK (1988) Localisation of α interferon in the human feto-placental unit. *J Endocrinol* **119** 531-534.

Huhtala ML, Seppala M, Narvanen A, Palomaki P, Julkunen M and Bohn H (1987) Amino acid sequence homology between placental protein 14 and β -lactoglobulins from various species. *Endocrinology* **120** 2620-2622.

- Hunt JS, Chen HL, Hu XL and Tabibzadeh S (1992) Tumor necrosis factor- α messenger ribonucleic acid and protein in human endometrium. *Biol Reprod* **47** 141-147.
- Ihle JN and Kerr IM (1995) Jaks and Stats in signaling by the cytokine receptor superfamily. *Trends Genet* **11** 69-74.
- Iles RK and Chard T (1989) Enhancement of ectopic β human chorionic gonadotrophin expression by interferon α . *J Endocrinol* **123** 501-507.
- Imakawa K, Anthony RV, Kazemi M, Marotti KR, Polites HG and Roberts RM (1987) Interferon-like sequence of ovine trophoblast protein secreted by embryonic trophoderm. *Nature* **330** 377-379.
- Imakawa K, Hansen TR, Malathy PV, Anthony RV, Polites HG, Marotti KR and Roberts RM (1989) Molecular cloning and characterisation of complementary deoxyribonucleic acids corresponding to bovine trophoblast protein 1: A comparison with ovine trophoblast protein 1 and bovine interferon α II. *Mol Endo* **3** 127-139.
- Irwin JC, Kirk D, King RJ, Quigley MM and GwatkinRB (1989) Hormonal regulation of human endometrial stromal cells in culture: a model for decidualisation. *Fertil Steril* **52** 761-768.
- Isaacs A and Lindemann J (1957) Virus interference. I The Interferon. *Proc Roy Soc Lond (Biol)* **147** 258-267.
- Johnson M and Everitt B (1988) *Essential Reproduction*. 3rd Edition. Blackwell Scientific Publications Limited, Oxford.

Joshi AR, Sarkar FH and Gupta SL (1982) Interferon receptors. Cross-linking to human leukocytes interferon α -2 to its receptor on human cell. *J Biol Chem* **257** 13884-13887.

Julkunen M, Koistinen R, Sjoberg J, Rutanen E, Wahlstrom T and Seppala M (1986) Secretory endometrium synthesises placental protein 14. *Endocrinology* **118** 1782-1786.

Julkunen M, Koistinen R, Suikkari AM, Seppala M and Janne OA (1990) Identification by hybridisation histochemistry of human endometrial cells expressing mRNAs encoding a uterine β -lactoglobulin homologue and insulin-like growth factor-binding protein-1. *Mol Endocrinol* **4** 700-707.

Kaltenbach JP, Kaltenbach MH and Lyons WB (1958) Nigrosin as a dye for differentiating live and dead ascites cells. *Exp Cell Res* **15** 112-117.

Kaluz S, Fisher PA, Kaluzova M, Sheldrick EL and Flint AP (1996) Structure of an ovine interferon receptor and its expression in endometrium. *J Mol Endocrinol* **17** 207-215.

Kessler DS and Levy DE (1991) Protein kinase activity required for an early step in interferon α signalling. *J Biol Chem* **266** 23471-23476.

Khan OA, Xia Q, Bever CT Jnr, Mohnson KP, Panitch HS and Dhib-Jalbut SS (1996) Interferon β -1b serum levels in multiple sclerosis patients following subcutaneous administration. *Neurology* **46** 1639-1643.

Kirito K, Nagashima T, Ozawa K and Komatsu N (2002) Constitutive activation of STAT1 and STAT3 in primary erythroleukaemia cells. *Int J Hematol* **75** 51-54.

Kojima K, Kanzaki H, Iwai M, Hatayama H, Fujimoto M, Inoue T, Horie K, Nakayama H, Fujita J and Mori T (1994) Expression of leukaemia inhibitory factor in human endometrium and placenta. *Biol Reprod* **50** 882-887.

Kunisada K, Hirota H, Fujio Y, Matsui H, Tani Y, Yamauchi-Takahara K and Kishimoto T (1996) Activation of Jak-STAT and MAP kinases by Leukemia Inhibitory Factor through gp130 in cardiac myocytes. *Circulation* **94** 2626-2632.

Laemmli UK (1970) Cleavage of structural proteins during the assembly of the head of bacteriophage T4. *Nature* **227** 680-685.

Laird SM, Li TC and Bolton AE (1993) The production of placental protein 14 and interleukin 6 by human endometrial cells in culture. *Human Reprod* **8** 793-798.

Laird SM, Hill CJ, Warren MA, Tuckerman EM and Li TC (1995) The production of placental protein 14 by human uterine tubal epithelial cells in culture. *Human Reprod* **10** 1346-1351.

Laird SM, Tuckerman EM, Saravelos H and Li TC (1996) The production of tumour necrosis factor α (TNF α) by human endometrial cells in culture. *Human Reprod* **11** 1318-1323.

Laird SM, Tuckerman EM, Dalton CF, Dunphy BC, Li TC and Zhang X (1997) The production of leukaemia inhibitory factor by human endometrium: presence in uterine flushings and production by cells in culture. *Human Reprod* **12** 569-574.

Lee BS, Stewart EA, Sahakian M and Nowak RA (1998) Interferon α is a potent inhibitor of basic fibroblast growth factor-stimulated cell proliferation in human uterine cells. *Am J Reprod Immunol* **40** 19-25.

Lenton EA, Neal LM and Suliaman R (1982) Plasma concentrations of human chorionic gonadotrophin from the time of implantation until the second week of pregnancy. *Fertil Steril* **37** 773-778.

Levy DE, Kessler DS, Pine R and Darnell JE Jr (1989) Cytoplasmic activation of ISGF3, the positive regulator of IFN α -stimulated transcription, reconstituted *in vitro*. *Genes and Dev* **3** 1362-1371.

Levy DE (1995) Interferon induction of gene expression through the Jak-STAT pathway. *Semin virol* **6** 181-189.

Lewerenz M, Morgensen KE and Uze G (1998) Shared receptor components but distinct complexes for α and β interferons. *J Mol Biol* **282** 585-599.

Li J and Roberts RM (1994) Interferon τ and interferon α interact with the same receptors in bovine endometrium. Use of a readily iodinated form of recombinant interferon τ for binding studies. *J Biol Chem* **269** 13544-13550.

Li Y, Matsuzaki N, Masuhiro K, Kameda T, Taniguchi T, Saji F, Yone K and Tanizawa O (1992) Trophoblast-derived tumour necrosis factor- α induces release of human chorionic gonadotrophin using interleukin-6 (IL-6) and IL-6-receptor-dependent system in the normal human trophoblasts. *J Clin Endocrinol Metab* **74** 184-191.

Liu HC, He ZY, Mele C, Damario M, Davis O and Rosenwaks Z (1997) Hormonal regulation of mRNA encoding insulin-like binding proteins in human endometrial stromal cells cultured *in vitro*. *Mol Human Reprod* **3** 21-26.

Llewellyn-Jones, D (1978) *Fundamentals of Obstetrics and Gynaecology. Volume 2: Gynaecology. 2nd Ed.* Faber and Faber Limited, London.

Lorenzetti R, Monaco L, Sidoli A, Sorrentino V and Soria M (1984) Fibroblast interferon from a human amniotic cell line: a strategy for rapid molecular cloning. *Microbiologica* **7** 229-242.

Lutfalla G, Holland SJ, Cinato E, Monneron D, Reboul J, Rogers NC, Smith JM, Stark GR, Gardiner K, Mogensen KE, Kerr IM and Uze G (1995) Mutant U5A cells are complemented by an interferon- α β receptor subunit generated by alternative processing of a new member of a cytokine receptor gene cluster. *EMBO J* **14** 5100-5108.

Mann GE, Lamming GE, Robinson RS and Wathes DC (1999) The regulation of IFN τ production and uterine hormone receptors during early pregnancy. *J Reprod Fertil Suppl* **54** 317-328.

- Marcucci F and De Maeyer E (1986) Natural interferon analogue [Ala 30, 32, 33] HuIFN α acting as a HuIFN α 2 antagonist on bovine cells. *Biochem Biophys Res Commun* **134** 1412-1418.
- Marrack P, Kappler J and Mitchell T (1999) Type I interferons keep activated T cells alive. *J Exp Med* **189** 521-529.
- May LT, Ghrayeb J, Santhanam U, Tatter SB, Stoeber Z, Helfgott DC, Chiorazzi N, Grienering G and Sehgal PB (1988) Synthesis and secretion of multiple forms of β 2-interferon/B-cell differentiation factor-2/hepatocyte-stimulating factor by human fibroblasts and monocytes. *J Biol Chem* **263** 7760-7766.
- Michell RH (1975) Inositol phospholipids and cell surface receptor function. *Biochim Biophys Acta* **415** 81-147.
- Migone TS, Lin JX, Cereseto A, Mulloy JC, O'Shea JJ, Franchini G and Leonard WJ (1995) Constitutively activated Jak-STAT pathway in T cells transformed with HTLV-1. *Science* **269** 79-81.
- Mitani Y, Takaoka A, Kim SH, Kato Y, Yokochi T, Tanaka N and Taniguchi T (2001) Cross talk of the interferon- α/β signalling complex with gp130 for effective interleukin-6 signalling. *Genes Cells* **6** 631-640.
- Mitchell SN and Smith SK (1990) Progesterone and human interferon α -2 have a different effect on the release of PGF $_{2\alpha}$ from human endometrium. *Adv Prost Thromb Leuk Res* **21** 823-826.

Mitchell SN and Smith SK (1992) The effect of progesterone and human interferon α -2 on the release of $\text{PGF}_{2\alpha}$ and PGE from epithelial cells of human proliferative endometrium. *Prostaglandins* **44** 457-470.

Mizuki M, Fenski R, Halfter H, Matsumura I, Schmidt R, Muller C, Gruning W, Kratz-Albers K, Serve S, Steur C, Buchner T, Kienast J, Kanakura Y, Berdel WE and Serve H (2000) Flt3 mutations from patients with acute myeloid leukemia induce transformation of 32D cells mediated by the Ras and STAT5 pathways. *Blood* **96** 3907-3914.

Muller M, Briscoe J, Laxton C, Guschin D, Ziemiecki A, Silvennoinen O, Harpur AG, Barbieri G, Witthuhn BA, Schindler C et al (1993) The protein tyrosine kinase JAK1 complements a mutant cell line defective in the interferon- α/β and $-\gamma$ signal transduction pathways. *Nature* **366** 129-135.

Muller M, Ibelgaufts H and Kerr IM (1994) Inteferon response pathways – a paradigm for cytokine signalling? *J Viral Hepatitis* **1** 87-103.

Nakamura T, Nawa K and Ichihara A (1984) Partial purification and characterization of hepatocyte growth factor from serum of hepatectomized rats. *Biochem Biophys Res Commun* **122** 1450-1459

Nasu K, Matsui N, Narahara H, Tanaka Y and Miyakawa I (1998) Effects of interferon- γ on cytokine production by endometrial stromal cells. *Human Reprod* **13** 2598-2601

Nasu K, Sugano T, Matsui N, Narahara H, Kawano Y and Miyakawa I (1999) Expression of hepatocyte growth factor in cultured human endometrial stromal cells is induced through a protein kinase C-dependent pathway. *Biol Reprod* **60** 1183-1187

Negami AI, Sasaki H, Kawakami Y, Kamitani N, Kotsuji F, Tominaga T and Nakamura T (1995) Serum human hepatocyte growth factor in human menstrual cycle and pregnancy: a novel serum marker of regeneration and reconstruction of human endometrium. *Horm Res* **44** 42-46

Nishino E, Matsuzaki N, Masuhiro K, Kameda T, Taniguchi T, Takagi T, Saji F and Tanizawa O (1990) Trophoblast-derived interleukin-6 (IL-6) regulates human chorionic gonadotrophin release through IL-6 receptor on human trophoblasts. *J Clin Endocrinol Metab* **71** 436-441.

Nishizuka Y (1988) The molecular heterogeneity of protein kinase C and its implications for cellular regulation. *Science* **334** 661-665.

Norton AJ, Jordan S and Yeomans P (1994) Brief, high-temperature heat denaturation (pressure cooking): a simple and effective method of antigen retrieval for routinely processed tissues. *J Pathol* **173** 371-379.

Norwitz ER, Schust DJ and Fisher SJ (2001) Implantation and the survival of early pregnancy. *N Engl J Med* **345** 1400-1408.

Novick D, Cohen B and Rubenstein M (1992) Soluble interferon α receptor molecules are present in body fluids. *FEBS Lett* **314** 445-448.

Novick D, Cohen B and Rubenstein M (1994) The human interferon α/β receptor: characterisation and molecular cloning. *Cell* **77** 391-400.

O'Brien KB, O'Shea JJ and Carter-Su C (2002) SH2-B family members differentially regulate JAK family tyrosine kinases. *J Biol Chem* **277** 8673-8681.

Oehninger S, Coddington CC, Hodgen GD and Seppala M (1995) Factors affecting fertilisation: endometrial placental protein 14 reduces the capacity of human spermatozoa to bind to the human zona pellucida. *Fertil & Steril* **63** 377-383.

Okamoto N, Uchida A, Takakura K, Kariya Y, Kanzaki H, Rittinen L, Koistinen K, Seppala M and Mori T (1991) Suppression by human placental protein 14 of natural killer cell activity. *Am J Reprod Immunol* **26** 137-142.

Olajide F and Chard T (1992) Biological and clinical significance of the endometrial protein PP14 in reproductive endocrinology. *Obstet and Gynaecol Sur* **47** 252-257.

Overall JC and Glasgow LA (1970) Foetal responses to viral infection: interferon production in sheep. *Science* **167** 1139-1141.

Ozaki T, Takahashi K, Kanasaki H, Iida K and Miyazaki K (2005) Expression of the type I interferon receptor and the interferon-induced Mx protein in human endometrium during the menstrual cycle. *Fertil Steril* **83** 163-170.

Paulesu L, Bocci V, King A and Loke YM (1991) Immunocytochemical localisation of interferons in human trophoblast populations. *J Biol Reg Hom Agents* **5** 81-85.

Pellegrini S, John J, Shearer M, Kerr IM and Stark GR (1989) Use of a selectable marker regulated by α interferon to obtain mutations in the signalling pathway. *Mol Cell Biol* **9** 4605-4612.

Pellegrini S and Schindler C (1993) Early events in signalling by interferons. *Trends Biochem Sci* **18** 338-342.

Pfeffer LM, Donner DB and Tamm I (1987) Interferon- α down-regulates insulin receptors in lymphoblastoid (Daudi) cells. Relationship to inhibition of cell proliferation. *J Biol Chem* **262** 3665-3670.

Pfeffer LM, Strulovici B and Saltiel AR (1990) Interferon α selectively activates the β isoform of protein kinase C through phosphatidylcholine hydrolysis. *Proc Natl Acad Sci USA* **87** 6537-6541.

Philippeaux MM and Piguet PF (1993) Expression of tumor necrosis factor α and its mRNA in the endometrial mucosa during the menstrual cycle. *Am J Pathol* **143** 480-486.

Pockley AG, Mowles EA, Stoker RJ, Westwood OMR, Chapman MG and Bolton AE (1988) Suppression of *in vitro* lymphocyte reactivity to phytohemagglutinin by placental protein 14. *J Reprod Immunol* **13** 31-39.

Pontzer CH, Bazer FW and Johnson HM (1991) Antiproliferative activity of a pregnancy recognition hormone, ovine trophoblast protein-1. *Cancer Res* **51** 5304-

Popescu LM, Cernescu C, Moraru II, Constantinescu SN, Balta F, Manciulea M, Brailoiu E and Buzila L (1989) Cell-membrane phospholipase C is involved in inducing the antiviral effect of interferon. *Biosci Rep* **9** 531-539.

Powell CB, Manning K and Collins JL (1993) IFN α induces a cytolytic mechanism in ovarian carcinoma cells through a protein kinase C-dependent pathway. *Gynecol Oncol* **50** 208-214.

Radhakrishnan R, Walter LG, Subramaniam PS, Johnson HM and Walter MR (1999) Crystal structure of ovine interferon τ at 2.1Å resolution. *J Mol Biol* **286** 151-162.

Rani MRS, Foster GR, Leung S, Leaman D, Stark GR and Ransohoff RM (1996) Characterisation of β -R1, a gene that is selectively induced by interferon β (IFN β) compared with IFN α . *J Biol Chem* **271** 22878-22884.

Rasmussen H (1991) Preface. In: Rasmussen H (Ed). *Cell communication in health and disease*. Freeman: New York, pp vii-xii.

Ray CG (1970) The ontogeny of interferon production by human leukocytes. *J Pediat* **76** 94-98.

Reich NC and Pfeffer LM (1990) Evidence for involvement of protein kinase C in the cellular response to interferon α . *Proc Natl Acad Sci USA* **87** 8761-8765.

Reis LF, Dos Santos JR, Ferreira PC, Kroon EG and Golgher RR (1989) Antigenic characterisation of human interferon derived from amniotic membranes induced by virus. *J Interferon Res* **9** 573-581.

- Rice A and Chard T (1998) Cytokines in implantation. *Cytokine and Growth Factor Reviews* **9** 287-296.
- Rice A, Parrington J, Jones KT and Swann K (2000) Mammalian sperm contain a Ca^{2+} -sensitive phospholipase C activity that can generate InsP_3 from PIP_2 associated with intracellular organelles. *Dev Biol* **228** 125-135.
- Ricketts RM and Jones DB (1985) Differential effect of human chorionic gonadotrophin on lymphocyte proliferation induced by mitogens. *J Reprod Immunol* **7** 225-232.
- Roberts RM (1991) A role for interferons in early pregnancy. *Bioassays* **13** 121-126.
- Roberts RM, Cross JC and Leaman DW (1992) Interferons as hormones of pregnancy. *Endocrine Rev* **13** 432-452.
- Roldan ERS and Harrison RAP (1989) Polyphosphoinositide breakdown and subsequent exocytosis in the Ca^{2+} /ionophore-induced acrosome reaction of mammalian spermatozoa. *Biochem J* **259** 397-406.
- Rubinstein M, Rubinstein S, Familletti PC, Gross MS, Miller RS, Waldman AA and Pestka S (1978) Human leukocyte interferon purified to homogeneity. *Science* **202** 1289-1290.
- Runkel L, Pfeffer L, Lewerenz M, Monneron D, Yang CH, Murti A, Pellegrini S, Goetz S, Uze G and Mogensen K (1998) Differences in activity between α and β type I interferons explored by mutational analysis. *J Biol Chem* **273** 8003-8008.

- Russell DL, Manalo GG, Findlay JK and Salamonsen LA (1993) Binding sites for interferons on ovine and human endometrial membranes. *Reprod Fertil Dev* **5** 219-227.
- Ruvkun G and Hobert O (1998) The taxonomy of developmental control in *Caenorhabditis elegans*. *Science* **282** 2033-2041.
- Salamonsen LA, Kovacs GT and Findlay JK (1999) Current concepts of the mechanisms of menstruation. *Baillieres Best Pract Res Clin Obstet Gynaecol* **13** 161-179.
- Schindler C, Shuai K, Prezioso VR and Darnell JE Jr (1992) Interferon-dependent tyrosine phosphorylation of a latent cytoplasmic transcription factor. *Science* **257** 744-745.
- Schuringa J-J, Wierenga ATJ, Kruijer W and Vellenga E (2000) Constitutive STAT3, Tyr705 and Ser727 phosphorylation in acute myeloid leukemia cells caused by the autocrine secretion of interleukin-6. *Blood* **95** 3765-3770.
- Sen GC and Lengyel P (1992) The interferon system. *J Biol Chem* **267** 5017-5020.
- Seppala M, Koskimies AI, Tenhunen A, Rutanen EM, Sjoberg J, Koistinen R, Julkunen M and Wahlstrom T (1985) Pregnancy proteins in seminal plasma, seminal vesicles, preovulatory follicular fluid and ovary. *Ann NY Acad Sci* **442** 212-226.
- Seppala M (1999) Glycodelins: biological activity in reproduction and differentiation. *Curr Opin Obstet Gynecol* **11** 261-263.

Short RV (1969) Implantation and the maternal recognition of pregnancy. In: Fetal autonomy. Ciba Found Symp. Churchill. 2-26.

Shukla SD and Hanahan DJ (1984) Acetylglycerol ether phosphorylcholine (AGEPC; platelet-activating factor) -induced stimulation of rabbit platelets: correlation between phosphatidic acid level, $^{45}\text{Ca}^{2+}$ uptake and [^3H]serotonin secretion. Arch Biochem Biophys **232** 458-466.

Smith AG, Nichols J, Robertson M and Rathjen PJ (1992) Differentiation inhibiting activity (DIA/LIF) and mouse development. Dev Biol **151** 339-351.

Spencer TE, Ing NH, Ott TL, Mayes JS, Becker WC, Watson GH, Miranda MA and Bazer FW (1995) Intrauterine injection of ovine interferon τ alters oestrogen receptor and oxytocin receptor expression in the endometrium of cyclic ewes. J Mol Endocrinol **15** 203-220.

Spiekermann K, Biethahn S, Wilde D, Hiddemann W and Alves F (2001) Constitutive activation of STAT transcription factors in acute myelogenous leukemia. Eur J Haematol **67** 63-71.

Stark GR, Kerr IM, Williams BRG, Silverman RH and Schreiber RD (1998) How cells respond to interferons. Ann Rev Biochem **67** 227-264.

Stephanou A and Handwerger S (1994) Interleukin-6 stimulates placental lactogen expression by human trophoblast cells. Endocrinology **135** 719-723.

Stewart CL, Kaspar P, Brunet LJ, Bhatt H, Gadi I, Kontgen F and Abbondanzo S (1992) Blastocyst implantation depends on maternal expression of leukaemia inhibitory factor. *Nature* **359** 76-79.

Stewart HJ, McCann SHE, Barker PJ, Lee KE, Lamming GE and Flint APF (1987) Interferon sequence homology and receptor binding activity of ovine trophoblast antiluteolytic protein. *J Endocrinol* **115** R13-15.

Stewart HJ, Flint APF, Lamming GE, McCann SHE and Parkinson TJ (1989) Antiluteolytic effects of blastocyst-secreted interferon investigated *in vitro* and *in vivo* in the sheep. *J Reprod Fertil Suppl* **37** 127-138.

Stewart MD, Johnson GA, Vyhldal CA, Burghardt RC, Safe SH, Yu-Lee LY, Bazer FW and Spencer TE (2001) Interferon- τ activates multiple signal transducer and activator of transcription proteins and has complex effects on interferon-responsive gene transcription in ovine endometrial epithelial cells. *Endocrinology* **142** 98-107.

Stewart WE II (1979) The interferon system. 134-183, Springer-Verlag, New York.

Su DM, Wang J, Lin Q, Cooper MD and Watanabe T (1997) Interferons α/β inhibit IL-7-induced proliferation of CD4⁻, CD8⁻, CD3⁻, CD44⁺, CD25⁺ thymocytes but do not inhibit that of CD4⁻, CD8⁻, CD3⁻, CD44⁻, CD25⁻ thymocytes. *Immunology* **90** 543-549.

Su L and David M (2000) Distinct mechanisms of STAT phosphorylation via the interferon- α/β receptor. *J Biol Chem* **275** 12661-12666.

Sugawara J, Fukaya T, Murakami T, Yoshida H and Yajima A (1997) Increased secretion of hepatocyte growth factor by eutopic endometrial stromal cells in women with endometriosis. *Fertil Steril* **68** 468-472.

Sugawara J, Fukaya T, Murakami T, Yoshida H and Yajima A (1997) Hepatocyte growth factor stimulated proliferation, migration and lumen formation of human endometrial epithelial cells *in vitro*. *Biol Reprod* **57** 936-942.

Sugiyama T, Nishio Y, Kishimoto T and Akira S (1996) Identification of alternative splicing form of STAT2. *FEBS Lett* **381** 191-194.

Sutherland EW (1972) Studies on the mechanism of hormone action. *Science* **177** 401-408.

Tabibzadeh SS, Satyaswaroop PG and Pao PN (1988) Antiproliferative effect of interferon γ in human endometrial epithelial cells *in vitro* : potential local growth modulatory role in endometrium. *J Clin Endocrinol Metab* **67** 131-138.

Tabibzadeh SS, Santhanam U, Sehgal PB and May LT (1989) Cytokine-induced production of IFN- β 2/IL-6 by freshly explanted human endometrial stromal cells. Modulation by estradiol-17 β . *J Immunol* **142** 3134-3139.

Tabibzadeh S (1991a) Ubiquitous expression of TNF α /cachectin immunoreactivity in human endometrium. *Am J Reprod Immunol* **26** 1-4.

Tabibzadeh S (1991b) Cytokine regulation of human endometrial function. *Ann NY Acad Sci* **622** 89-98.

Tabibzadeh S (1994) Regulatory roles of IFN γ in human endometrium. *Ann NY Acad Sci* **734** 1-6.

Tabibzadeh S, Zupi E, Babaknia A, Liu R, Marconi D and Romanini C (1995) Site and menstrual cycle-dependent expression of proteins of the tumour necrosis factor (TNF) receptor family, and BCL-2 oncoprotein and phase-specific production of TNF α in human endometrium. *Hum Reprod* **10** 277-286.

Taguchi F, Kajioaka J and Shimada N (1985) Presence of interferon and antibodies to BK virus in amniotic fluid of normal pregnant women. *Acta Virol* **29** 299-304.

Taylor RN, Savouret JF, Vaisse C, Vigne JL, Ryan I, Hornung D, Seppala M and Milstrom E (1998) Promegestone (R5020) and mifepristone (RU486) both function as progestational agonists of human glycodeclin gene expression in isolated human epithelial cells. *J Clin Endocrinol Metab* **83** 4006-4012.

Toth FD, Norskov-Lauritsen N, Juhl C and Ebbesen P (1991) Human trophoblast interferon: Pattern of response to priming and superinduction of purified term trophoblast and choriocarcinoma cells. *J Reprod Immunol* **19** 55-67.

Tough DF, Borrow P and Sprent J (1996) Induction of bystander T-cell proliferation by viruses and Type I interferon *in vivo*. *Science* **272** 1947-1950.

Uddin S, Lekmine F, Sharma N, Majchrzak B, Mayer I, Young PR, Bokoch GM, Fish EN and Plataniias LC (2002a) The Rac1/p38 mitogen-activated protein kinase pathway is required for interferon α -dependent transcriptional activation but not serine phosphorylation of STAT proteins. *J Biol Chem* **275** 27634-27640.

Uddin S, Sassano A, Deb DK, Verma A, Marjchrzak B, Rahman A, Malik AB, Fish EN and Plataniias LC (2002b) Protein kinase C- δ (PKC- δ) is activated by Type I interferons and mediates phosphorylation of STAT1 on serine 727. *J Biol Chem* **277** 14408-14416.

Uze G, Lutfalla G and Gresser I (1990) Genetic transfer of a functional human interferon α receptor into mouse cells: cloning and expression of its cDNA. *Cell* **60** 225-234.

Uzumcu M, Carnahan KG, Braileanu GT and Mirando MA (2000) Oxytocin-stimulated phosphoinositide hydrolysis and prostaglandin F₂ α secretion by luminal epithelial, glandular epithelial and stromal cells from pig endometrium. II. Response of cyclic, pregnant and pseudopregnant pigs on days 12 and 16 post oestrus. *Reprod Fertil Dev* **12** 157-164.

Vallet JL and Bazer FW (1989) Effect of ovine trophoblast protein-1, oestrogen and progesterone on oxytocin-induced phosphatidylinositol turnover in endometrium of sheep. *J Reprod Fertil* **87** 755-761.

Velazquez L, Fellous M, Stark GR and Pellegrini S (1992) A protein tyrosine kinase in the interferon α/β signalling pathway. *Cell* **70** 313-322.

Vilcek J, Gray PW, Rinderknecht E and Sevastopoulos CG (1985) Interferon γ : a lymphokine for all seasons. *Lymphokines* **11** 1-32.

von Wolff M, Classen-Linke I, Heid D, Krusche CA, Beier-Hellwig K, Karl C and Beier HM (1999) Tumour necrosis factor- α (TNF- α) in human endometrium and uterine secretion: an evaluation by immunohistochemistry, ELISA and semiquantitative RT-PCR. *Mol Human Reprod* **5** 146-152.

Walsh DA, Perkins JP and Krebs EG (1968) An adenosine 3', 5'-monophosphate-dependent protein kinase from rabbit skeletal muscle. *J Biol Chem* **243** 3763-3765.

Wang HS, Perry LA, Kanisius J, Iles RK, Holly JMP and Chard T (1991) Purification and assay of insulin-like growth factor binding protein-1; measurement of circulating levels throughout pregnancy. *J Endocrinol* **128** 161-168.

Wang HS and Chard T (1992) The role of insulin-like growth factor-I and insulin-like growth factor binding protein-1 (IGFBP-1) in the control of human fetal growth. *J Endocrinol* **132** 11-19.

Weidner KM, Arakaki N, Hartmann G, Vandekerckhove J, Weingart S, Rieder H, Fonatsch C, Tsubouchi H, Hishida T, Daikuhara Y and Birchmeier W (1991) Evidence for the identity of human scatter factor and hepatocyte growth factor. *Proc Natl Acad Sci USA* **88** 7001-7005.

Williams RL, Hilton DJ, Pease S, Willson TA, Stewart CL, Gearing DP, Wagner EF, Metcalf D, Nicola NA and Gough NM (1988) Myeloid leukaemia inhibitory factor maintains the developmental potential of embryonic stem cells. *Nature* **336** 684-687.

Wilson V, Jeffreys AJ, Barrie PA, Boseley PG, Slocombe PM, Easton A and Burke DC (1983) A comparison of vertebrate interferon gene families detected by hybridization with human interferon DNA. *J Mol Biol* **166** 457-475.

Wolvekamp MC and Marquet RL (1990) Interleukin-6: historical background, genetics and biological significance. *Immunol Lett* **24** 1-9.

Wood PL, Walker RA and Bell SC (1989) Serum levels of pregnancy-associated α 2-globulin (α 2-PEG) during normal menstrual and combined oral contraceptive cycles and relationship to immuno-histological localization. *Human Reprod* **4** 140-146.

Yamada K, Shimizu Y, Okamura K, Kumagai K and Suzuki M (1985) Study of interferon production during pregnancy in mice and antiviral activity in the placenta. *Am J Obstet Gynecol* **153** 335-341.

Yap WH, Teo TS, McCoy E and Tan YH (1986) Rapid and transient rise in diacylglycerol concentration in Daudi cells exposed to interferon. *Proc Natl Acad Sci USA* **83** 7765-7769.

Yap WH, Teo TS and Tan YH (1986) An early event in the interferon-induced transmembrane signalling process. *Science* **234** 255-258.

Yeaman GR, Collins JE, Currie JK, Guyre PM, Wira CR and Fanger MW (1998) IFN- γ is produced by polymorphonuclear neutrophils in human uterine endometrium and by cultured peripheral blood polymorphonuclear neutrophils. *J Immunol* **160** 5145-5153.

Yip YK, Barrowclough BS, Urban C and Vilcek J (1982) Molecular weight of human γ interferon is similar to that of other human interferons. *Science* **215** 411-413.

Zhou J, Dsupin BA, Giudice LC and Bondy CA (1994) Insulin-like growth factor system gene expression in human endometrium during the menstrual cycle. *J Clin Endocrinol Metab* **79** 1723-1734.

Zoumpoulidou G, Jones MC, Fernandez de Mattos S, Francis JM, Fusi L, Lee YS, Christian M, Varshochi R, Lam EW and Brosens JJ (2004) Convergence of interferon-gamma and progesterone signaling pathways in human endometrium: role of PIASy (protein inhibitor of activated signal transducer and activator of transcription- γ). *Mol Endocrinol.* **18** 1988-99.

Websites:

www.nlm.nih.gov/medlineplus/ency/images accessed 2006

www.rcsb.org accessed 2006