

*The Economies of Deprived  
Neighbourhoods*

---

Summary of Research

The Economies of Deprived  
Neighbourhoods  
Summary of Research

### **Economies of Deprived Neighbourhoods – Summary of Research**

Authors: Professor David North, Professor Stephen Syrett, and Dr Melvyn Evans, Centre for Enterprise and Economic Development Research, Middlesex University; Professor Ian Sanderson, Policy Research Institute, Leeds Metropolitan University (now Head of Analytical Services, Scottish Executive); and Professor Colin Williams, School of Management, University of Sheffield

**Acknowledgements:** The authors would like to acknowledge the contribution of Robert Baldock, Stacey Clift, Mark Ramsden, and Ian Vickers to the research and of Andrew Maginn of the Neighbourhood Renewal Unit for managing these three reviews.

### **The Dynamics of Local Economies**

**Authors:** Professor David North and Professor Stephen Syrett, Centre for Enterprise and Economic Development Research, Middlesex University

**Acknowledgements:** The authors would like to acknowledge the contribution of Robert Baldock, Stacey Clift, Mark Ramsden, and Ian Vickers to the research.

### **Worklessness Review**

**Authors:** Professor Ian Sanderson, Policy Research Institute, Leeds Metropolitan University (now Head of Analytical Services, Scottish Executive)

### **Informal Economic Activities**

**Authors:** Dr Melvyn Evans and Professor Stephen Syrett, Centre for Enterprise and Economic Development Research, Middlesex University, and Professor Colin Williams, School of Management, University of Sheffield

**Acknowledgement:** The authors would like to acknowledge the contribution of Stacey Clift to the research.

Department for Communities and Local Government  
Eland House  
Bressenden Place  
London  
SW1E 5DU  
Telephone: 020 7944 4400  
Website: [www.communities.gov.uk](http://www.communities.gov.uk)

© Crown Copyright, 2006

*Copyright in the typographical arrangement rests with the Crown.*

*This publication, excluding logos, may be reproduced free of charge in any format or medium for research, private study or for internal circulation within an organisation. This is subject to it being reproduced accurately and not used in a misleading context. The material must be acknowledged as Crown copyright and the title of the publication specified.*

Any other use of the contents of this publication would require a copyright licence. Please apply for a Click-Use Licence for core material at [www.opsi.gov.uk/click-use/system/online/pLogin.asp](http://www.opsi.gov.uk/click-use/system/online/pLogin.asp), or by writing to the Office of Public Sector Information, Information Policy Team, St Clements House, 2-16 Colegate, Norwich, NR3 1BQ. Fax: 01603 723000 or email: [HMSOlicensing@cabinet-office.x.gsi.gov.uk](mailto:HMSOlicensing@cabinet-office.x.gsi.gov.uk)

Further copies of this publication and alternative formats are available from:

DCLG Publications  
PO Box 236  
Wetherby  
West Yorkshire  
LS23 7NB  
Tel: 08701 226 236  
Fax: 08701 226 237  
Textphone: 08701 207 405  
Email: [communities@twoten.com](mailto:communities@twoten.com)

or online via the DCLG website: [www.communities.gov.uk](http://www.communities.gov.uk)

Printed in the UK on material containing no less than 75% post-consumer waste.

June 2006

Product Code: 06 NRU 03863

Under cover of this title you will find three summaries of recent research undertaken during 2004 and 2005 on different aspects of economic development in deprived areas and a synthesis document drawing together information from the three reports.

The full reports:

*The Dynamics of Local Economies and Deprived Neighbourhoods*

*Worklessness in Deprived Neighbourhoods: A Review of Evidence*

*Informal Economic Activities and Deprived Neighbourhoods*

are available on the DCLG website: [www.communities.gov.uk](http://www.communities.gov.uk)



# CONTENTS

The Economies of Deprived Neighbourhoods Synopsis Report	7
The Dynamics of Local Economies and Deprived Neighbourhoods – Summary	17
Worklessness in Deprived Neighbourhoods: A Review of Evidence – Summary	79
Informal Economic Activities and Deprived Neighbourhoods – Summary	91



# The Economies of Deprived Neighbourhoods

Synopsis Report





# CONTENTS

Introduction	11
Conclusions and key policy issues	11
The dynamics of local economies	12
Worklessness in deprived neighbourhoods	13
Informal economic activities in deprived neighbourhoods	14



## Introduction

This publication summarises three recent research reports devoted to the economies of deprived neighbourhoods. These are:

- *The Dynamics of Local Economies and Deprived Neighbourhoods* (Centre for Enterprise and Economic Development Research (CEEDR) Middlesex University, 2004)
- *Worklessness in Deprived Neighbourhoods: A Review of Evidence* (Policy Research Institute, Leeds Metropolitan University, 2004)
- *Informal Economic Activities and Deprived Neighbourhoods* (CEEDR, 2004)

The notion of sustainable employment as a route out of poverty and social exclusion is integral to the *National Strategy for Neighbourhood Renewal*. These three studies were designed to illuminate how it can be achieved, highlighting opportunities and constraints. They each involved a review of existing evidence with limited additional research.

## Conclusions and key policy issues

Three critical conclusions emerge from these studies:

- there is an increasing concentration of the problem of worklessness among particular groups and neighbourhoods
- it's clear that the problem is one of *multiple disadvantage*, combining individual, household and contextual factors – including institutional behaviour
- existing policies, while reducing worklessness overall, have not worked as well for those who are least competitive in the labour market

The studies identify a range of implications from these conclusions, including:

*Integrating neighbourhood strategies in their wider context:* the *Dynamics of local economies* paper argues that ‘deprived neighbourhoods are part of the wider economic system, and any dealing with them in isolation from this broader economic context is likely to lead to a mis-specification of their problems’. Integrating neighbourhood renewal strategies with economic development strategies at district, sub-regional and regional levels requires closer institutional links between neighbourhood partnerships, Local Strategic Partnerships (LSPs) and Regional Development Agencies (RDAs).

- The role of neighbourhood economic initiatives: Despite the need to integrate neighbourhood level with bigger geographies, there remains a key role for neighbourhood-based economic initiatives (including Intermediate Labour Markets, or ILMs), as a way of improving employability and

promoting self-help. Community-based initiatives at neighbourhood level also help as part of an integrated package of employment support.

- Enhancing labour demand: Greater attention needs to be paid to the fine grain of labour demand, including processes. One of the principal barriers to employment for the residents of disadvantaged neighbourhoods concerns the recruitment practices of employers – but policy still focuses on the supply side.
- An integrated approach: The reports argue for the better alignment of housing and economic policy, ‘... given the importance of residential sorting mechanisms to the creations of concentrations of deprivation’. Furthermore, education and transport policies are seen as requiring better integration with jobs and employment policies.

## The dynamics of local economies

This study concerns the interconnections between the economies of disadvantaged neighbourhoods and the wider urban and regional economic areas they operate within.

The relationship between local economic performance and concentrations of unemployment is complex. The ‘disconnect’ between some deprived neighbourhoods and the wider economy persists, unaffected by sometimes inappropriate and ineffective policy responses. The evidence suggests that the case for targeting job creation initiatives on disadvantaged neighbourhoods is not strong, because of the difficulty attracting businesses and substantial leakage effects, ie many new jobs will not go to the existing residents.

The economies of disadvantaged neighbourhoods vary enormously, but a common feature is the relative weakness of the private sector (and hence, relative over-reliance on the public and the third sectors), together with relatively low levels of human, financial and physical capital. Some types of *social* capital may be strong, and, in particular, ‘bonding’ social capital which underlies neighbourhood solidarity – but that can lead to insularity, reflecting a lack of ‘bridging’ social capital (that is, the contacts and relationships to connect the neighbourhood to surrounding areas, including wider labour markets). Disadvantaged neighbourhoods can suffer from limited and poor quality services, with under-representation of private sector services (eg retail, financial services) leading to greater reliance on public services, which can then become stretched. Another issue is physical access, with sometimes inadequate and expensive transport links between deprived areas and neighbouring centres of employment.

While the trajectories of decline are clear, the literature on how to arrest or reserve the cycle is less developed and therefore of less immediate benefit to policy makers. The causes of economic weakness vary between neighbourhoods, with common features being: economic restructuring; sectoral change (from manufacturing to knowledge-based industries), creating a polarised workforce; and population churn and out-migration of those with the most skills. CEEDR note that ‘... the majority of disadvantaged neighbourhoods have, since their creation, been low income areas,’ with *concentrations* of

unemployed and low income households being outcomes of housing policy and markets. However, in aggregate, unemployment is argued to arise from deficiencies in demand in the wider labour market, eg regionally or nationally.

CEEDR argue that approaches that focus on very local job creation may misstate the problem, and ‘... distract attention from the forms of intervention required to make disadvantaged local residents effective competitors for jobs, either inside or outside the area.’ The importance of access to opportunities in the wider travel-to-work area is underlined.

## Worklessness in deprived neighbourhoods

Despite the overall increase in employment in recent years, this report shows that spatial disparities at local level have increased. Responses have largely consisted of active labour market policies focusing on supply, though critics have suggested that insufficient attention has been paid to demand, and especially to the mechanisms through which demand is articulated, with consequences for the accessibility of jobs to the residents of disadvantaged neighbourhoods. Concerns have also been expressed about local *institutional capacity* to tackle concentrations of worklessness. Explanations for these concentrations fall into two categories: those focusing on attitudes, motivations and behaviour of individuals, and those that emphasise structural processes and developments in work organisation creating unequal job prospects.

Spatial concentrations of worklessness include ‘hidden’ unemployment, with high levels of Incapacity Benefit claimants who live close to those seeking work. Intra-regional disparities are more pronounced than inter-regional, but significant disparities *between* disadvantaged neighbourhoods remain, in the character and scale of worklessness. A central point of the report is that *it is not the same problem everywhere*. Explanations for continued concentrations of unemployment vary, for example, relatively low levels of skills; uneven settlement of BME communities; inadequate links between employers and the unemployed; the unbalanced nature of industrial decline, and the uneven record of public services in responding effectively. However, the *precise* nature of the problem varies between neighbourhoods.

Impediments to progress fall into three broad categories:

First, there are factors *impeding access to work* for residents of disadvantaged neighbourhoods. Changes in the geography of employment are well-recognised. New low-skilled jobs have tended to be created in suburbs and away from inner and deprived neighbourhoods, while housing market rigidity and poor transport have made it hard for lower skilled people in deprived neighbourhoods to take up such work. This can be exacerbated by employers’ attitudes and practices, such as reliance on informal methods of recruitment.

The second category of impediment concerns the characteristics of the affected households. These include (in addition to skills and qualifications) family structure (especially one parent status), work history, health and ethnicity. The report notes that it is difficult to distinguish the relative influence of each factor, given their interdependence.

The third set relates to institutional constraints on local residents' ability to compete in the job market, the most important of which concern the housing market, which '... translates labour market outcomes into particular patterns and intensities of spatial segregation'. This reinforces the propensity to unemployment through a combination of 'postcode' discrimination, peer norms and detachment from networks of those in work. Institutional factors include fear of losing benefits, childcare, access to information – exacerbated by the increasing concentration of employment support services in city centres.

Synthesising evidence from all types of intervention, the report suggests that the following are most likely to be effective:

- community-based outreach, integrated with mainstream services
- integrated packages with strong emphasis on personal support, throughout the process including the early period of employment
- direct links with employers, both inside and outside the deprived area

The study concludes that interventions were generally having the least impact among those who were least competitive in the labour market – in other words, the residents of disadvantaged neighbourhoods. For example, job search advice and guidance was found to be most effective for those who were already job-ready. More generally, '... there is a lack of convincing evidence for the beneficial effects of training programmes'. Job subsidy schemes were found to be costly, with deadweight and substitution problems. Evidence suggested that national programmes (like Jobcentre Plus) '... did not significantly improve the employment prospects for the more disadvantaged client groups'.

## Informal economic activities in deprived neighbourhoods

This study argues that while most policy attention is focused on *formal* economic activity, it is also necessary to understand the role of *informal* economic activity when developing policy. The report observes that there is ambiguity as to whether informal economic activity is a potential solution or part of the problem, and lack of consensus about what to include under the heading 'informal'. Three categories are distinguished: informal *paid* work, informal *unpaid* work, and illegal activities – although in practice the third is largely ignored and it is argued it should not be considered as 'informal economic activity'.

While the study is clear that informal economic activity can be an important part of 'coping strategies' for some residents in deprived areas, at present it is '... at its most extensive in areas where there is economic dynamism and growth, where it mirrors and reinforces the social inequalities present in the formal economy'. By definition, it is hard to measure its scale, and estimates vary: one in 1997 suggested its value in the UK equated to 13 per cent of GDP, while the Government's estimate was 1.5 per cent.

'*Paid* informal work' is defined as 'hidden but in all other respects legal', and is principally to be found in better-off neighbourhoods. The study suggests motivations for paid informal work may vary between these areas and disadvantaged neighbourhoods: '... it is firmly embedded in unadulterated economic motives in affluent suburbs (but) in lower income neighbourhoods ... it is conducted ... to help each other out in a way that avoids any connotations of charity'. In some cases, informal employment networks may constitute a kind of social capital.

In disadvantaged neighbourhoods the study argues that *unpaid* informal work consists of a mix of 'mutual aid' (providing support for other households) and 'self-provisioning' (activities within the household). These activities include domestic chores like cleaning, DIY and childminding, but also caring. In disadvantaged neighbourhoods, the study argues, the emphasis is on informal networks; whereas government policy is largely directed towards relatively formal forms of association, a consequence of which is '... a predisposition towards developing a participatory culture more characteristic of affluent rather than lower-income areas, whilst the significance of one-to-one aid, which is more characteristic of deprived populations, is downplayed'.

The study concludes by reviewing some ways used to increase opportunities and capacity for self-help, eg tool-banks, self-help skills provision, and 'cheque-service' schemes, which establish links between self-help and the labour market. Methods of incentivising and supporting people to move from the informal to the formal economy are reviewed, and examples are used to show the promise of such approaches.





# The Dynamics of Local Economies and Deprived Neighbourhoods

## Summary



# CONTENTS

Introduction	21
<b>SUMMARY OF PART ONE (OVERVIEW AND ANALYSIS)</b>	<b>21</b>
Context and Aims	21
The Local Economy and its Wider Spatial Context	22
The Economic Distinctiveness of Deprived Neighbourhoods	24
Spirals of Decline	27
Case Study Findings	31
Issues for Policy Development	38
<b>SUMMARY OF PART TWO (CASE STUDIES)</b>	<b>40</b>
Case Study 1: Sunderland	40
Case Study 2: Oldham	47
Case Study 3: Mansfield	54
Case Study 4: Brighton and Hove	62
Case Study 5: Newham	69



## Introduction

This report is in two parts: Part One provides overview and analysis, drawing on literature and case study research. Part Two provides more detailed descriptions of the research case studies. The Summary reflects this, with Part One summarising Part One of the report, and Part Two summarising Part Two.

## Summary of Part One (Overview and Analysis)

### Context and Aims

- Issues of employment and economic development are central to current policy initiatives seeking to promote the regeneration of deprived neighbourhoods. Yet there remains an apparent limited understanding of the economic context in which concentrations of worklessness exist, and of the most appropriate types and levels of policy intervention. In consequence there is a lack of a strong economic dimension in much current neighbourhood renewal activity which is constraining its effectiveness.
- An improved understanding of the economic dimension to the problems of deprived neighbourhoods requires attention to three issues. First, how the structure of local economies – within which deprived neighbourhoods are located – is changing with regard to sectoral composition, local labour markets and the roles performed by private, public and third sectors. Second, the extent to which the economies of deprived neighbourhoods are fundamentally different from other neighbourhoods and the extent of variations between them. Third, the manner in which the economic features of deprived neighbourhoods are embedded within wider local, town/city and regional economies and labour markets.
- The objective of this review is to provide greater comprehension of the dynamics of local economies within which deprived neighbourhoods are located, in order to identify the implications and lessons for policy development within the context of the neighbourhood renewal agenda. It seeks to answer a number of related questions:
  - What are the characteristics of local economies and how are these embedded within wider urban, regional, national and global economies?
  - What are the differences in the dynamics of the economies within which deprived neighbourhoods are situated?

- What are the distinguishing economic features of deprived neighbourhoods, and how do these differ between areas and neighbourhoods?
- What are the economic dimensions of change processes, and is it possible to identify particular economic trajectories in the evolution of deprived neighbourhoods?
- The review presents evidence obtained from a comprehensive examination of existing literature, combined with original analysis of five local economies selected to ensure coverage of deprived neighbourhoods within different types of local/regional contexts (coalfields, inner city areas, coastal resorts, etc.). In each case study district, contrasting deprived neighbourhoods were analysed to highlight differences in the economic contexts in which neighbourhoods are situated.
- The review is divided into two parts. The first part combines a review of the existing literature followed by an overview of findings from the five case study areas to provide an evidence base for considering future policy development. The second part presents more detailed discussion of each of the five case study areas.

## The Local Economy and its Wider Spatial Context

### THE LOCAL ECONOMY IN CONTEXT

- What constitutes a local economy remains weakly defined. Central to all definitions is an emphasis upon how local level economic activity is fundamentally linked into wider national and international processes and structures, and understanding these linkages is central to the dynamics of local economies.
- Notions of local economic development are important in their explicit recognition that economic processes are profoundly territorial, and that spatial variation in levels of economic activity is a fundamental feature of the economic development process within market economies.
- Recent years have seen increasing recognition of the key role of local and regional scales in current processes of global economic development. The apparent shift away from the economic primacy of the nation state and a relative rise in the importance of firms, institutions and state bodies operating at the global and sub national scales points to a ‘rescaling’ of economic activities.
- The production of new patterns of spatial development, including localised concentrations of deprivation, are a key characteristic of recent processes of economic restructuring within a globalising economy.

## **ECONOMIC CHANGE AND SPATIAL DEVELOPMENT**

- A central feature of recent economic restructuring is the development of new spatial patterns of unemployment and worklessness throughout advanced industrial economies. In the UK, high levels of unemployment and inactivity have become entrenched within certain groups and areas, particularly the large cities in northern Britain and inner London, but also former coalfield areas and some seaside towns.
- A major driver of such change in the UK has been the uneven spatial impact of job losses via processes of deindustrialisation and service sector led job growth. A defining feature of service sector employment growth has been the increasing polarisation between relatively well paid professionals working in the knowledge industries, and low paid workers in insecure and low grade service sector employment.
- Spatial concentrations of unemployment reflect a variety of factors including weak labour demand (eg in some older industrial northern towns and coalfield areas), the types of jobs being created and the relative inability of the most socially excluded to compete effectively for them (eg in London), and in-migration outstripping job growth (eg in seaside towns). Careful attention is required therefore to issues of supply and demand in local and regional labour markets, and their interaction with local housing markets and population change.

## **RELATIONSHIPS BETWEEN ECONOMIC COMPETITIVENESS AND SOCIAL COHESION**

- The persistence of concentrations of poverty and deprivation within prosperous as well as less prosperous urban areas in the UK is well-evidenced. That low-income disadvantaged neighbourhoods persist through successive periods of economic development suggests they perform a structural role within the operation of the wider urban economy, via the production and reproduction of low cost labour.
- The extent to which current concentrations of economic deprivation enable or constrain economic competitiveness remains poorly understood. Competitive success appears to be compatible with persistent concentrations of unemployment and does not eliminate inequality or concentrated disadvantage.
- The lack of strong evidence of the relationships between economic competitiveness and social cohesion may be partly due to the difficulty of identifying such complex relationships. However, it also suggests that the primary justification for policy intervention in deprived areas should be that of social justice, reducing poverty and improving the quality of people's lives, rather than relying upon improvements in economic efficiency and growth.



## LOCAL ECONOMIC POLICY AND SCALES OF INTERVENTION

- Whilst much local economic policy during the 1980s and 1990s was strongly oriented at the local authority district scale, during the 1990s a greater emphasis began to emerge upon a multi-level approach. The issue of how economic development is unfolding at different spatial scales, and its implications for the most appropriate level for policy intervention, is a central challenge for the development of local economic policy.
- Only a small proportion of economic activity is organised at the neighbourhood scale. Job markets and major investment decisions operate at higher spatial scales. Consequently the neighbourhood scale has traditionally been the focus for only a limited range of economic interventions.
- Neighbourhood economic activities play an important role in terms of quality of life and everyday coping strategies. Neighbourhood level interventions have particularly focused upon economic actions that create employment and additional sources of income, and also build social networks, local participation and co-operation, and develop community and individual capacities.
- The local scale has been the principal focus for much local economic policy in the UK largely because the local authority has had a key role in delivering national programmes and developing local strategies. However, the sub-regional level is commonly identified as the most important in terms of addressing many labour market issues.
- The limitations of spatially targeted initiatives to tackle the root causes of the problems they seek to address are well recognised. Area based initiatives do provide the appropriate level to understand local conditions and organise effective partnership action, but must be integrated and co-ordinated with policy interventions across different spatial scales, including mainstream government programmes.
- A central policy concern is how to link the socially excluded into processes of economic growth more effectively and best co-ordinate policy interventions operating at different spatial levels to achieve this. This requires careful understanding of the particular context of deprived areas and how they are linked into the wider sub-regional and regional context.

## The Economic Distinctiveness of Deprived Neighbourhoods

### ECONOMIC CHARACTERISTICS OF DEPRIVED NEIGHBOURHOODS

#### Types of capital

- In comparison to the economies of more prosperous areas, deprived neighbourhoods exhibit a relative weakness of the private sector in terms of employment, investment and service provision, with the public and third sectors assuming a relatively more important role.

- Deprived neighbourhoods are distinguished economically in terms of their labour market characteristics, most notably by relatively high levels of unemployment and worklessness, low rates of economic activity and employment, low levels of skills and education, and of wages and household income. Levels of formal entrepreneurship and small business formation also tend to be lower, whilst the role of informal economic activity is relatively more important for residents in terms of getting by on a day-to-day basis.
- Deprived neighbourhoods suffer from low levels of existing human, financial and physical capital. Attracting private finance and investment suffers from perceptions of weak market demand, low levels of skills and the adverse quality of the environment.
- In terms of social capital, deprived neighbourhoods with relatively stable populations may have levels of intra-community 'bonding' social capital that are equal to, or above, that of more affluent districts. The downside of heavily bonded communities is an insular and exclusionary local culture which limits connections to external networks. There is often an absence of extra-community 'bridging' social capital, which connects different groups and individuals to a wider range of social networks that extend beyond their community.

#### **Differences between deprived neighbourhoods**

- Although it is possible to identify certain common economic characteristics of deprived neighbourhoods they also exhibit fundamental differences.
- Residential sorting mechanisms, associated with the allocation of social housing and the availability of low cost rented property, are often the primary factors in the emergence of concentrations of deprivation. These sorting mechanisms vary within different neighbourhoods and have important second order effects.

#### **AREA EFFECTS AND ECONOMIC DEVELOPMENT IN DEPRIVED NEIGHBOURHOODS**

- A range of 'area effects' can be identified with respect to deprived neighbourhoods, which compound problems of concentrated disadvantage. A useful distinction is between those effects that flow from the characteristics of the population (eg socialisation processes, restricted social networks, stigmatisation of residents, high burden on local service provision), and those that flow from the characteristics of the place itself (poor-quality and/or absence of private services, lower standards of public service provision, features of the built environment, the physical isolation of a neighbourhood, and high levels of environmental pollution).
- There is considerable dispute within academic literature as to the existence of area effects and their relative importance. Whilst there is stronger evidence from the US, in the UK a number of reviews have concluded that the evidence for neighbourhood effects is weak and that they are less important than other factors. This lack of clarity in part results from the methodological problems of empirically demonstrating area effects.

### **Labour market exclusion**

- Existing evidence suggests that neighbourhood effects are marginal compared to factors related to individuals and households. However, neighbourhood effects do compound problems of labour market exclusion, most notably through the development of localised attitudes and expectations of work, restricted social networks and employer discrimination against stigmatised neighbourhoods.
- Constrained social networks are important in restricting access to the formal labour market. First, limited links to more advantaged mainstream groups, which provide important information, material support and moral/cultural examples results in restricted knowledge of workplace expectations, opportunities for career development and education and training, and the geographical scope of the job search process. Second, there is a lack of integration into informal recruitment practices which are routinely used by employers. Third, the movement out by those in employment removes role models and truncates the development of social networks which would help improve access to employment.
- There is evidence for the existence of the negative impacts of area reputation and stigma, but only limited research evidence of overt discrimination against employing residents from deprived neighbourhoods on the basis of their residential address (a form of 'postcode discrimination').

### **Levels of private sector activity and investment**

- A number of neighbourhood effects contribute to the low and declining levels of formal private sector activity that characterise deprived neighbourhoods. These include the nature of the local environment, low levels of demand and competition and active discrimination by businesses against stigmatised neighbourhoods.
- The withdrawal of private sector services from deprived areas has created 'under-served markets' in low income inner-city areas, which have attracted some businesses back to these areas. This process has been most apparent in the US. The potential for promoting greater business investment in underserved markets has been recognised in the UK.

### **Levels of public sector services and investment**

- The often poor quality of public sector services within deprived neighbourhoods reflects the characteristics of the population living within the area as well as the existence of a more difficult operating environment.
- Evidence for the poor quality and overstretched nature of public sector services in deprived areas is provided by a range of studies. The quality of public sector provision is important economically to deprived neighbourhoods in terms of the attractiveness of the physical environment to residents and businesses, the ability of residents to gain and retain employment, and the effectiveness of services directly related to employment and economic development.

## **IMPLICATIONS OF NEIGHBOURHOOD EFFECTS FOR POLICY DEVELOPMENT**

- The significance of neighbourhood effects is in how they compound other factors of disadvantage to shape the ‘opportunity structures’ of residents of deprived neighbourhoods. Policy development therefore needs to focus upon the importance of tackling problems within deprived areas in an integrated and simultaneous manner, through the complementary development of mainstream programmes and bottom-up neighbourhood policies.

## **Spirals of Decline**

- Considerable evidence exists of neighbourhoods entering spirals of decline, although there has been little attempt to model this process more formally. Better understanding of how spirals of decline occur in practice focuses attention on the dynamic processes creating spatially focused deprivation, and permits better identification of interventions that can arrest, reverse or prevent decline.

## **ECONOMIC CAUSES AND TRIGGERS FOR NEIGHBOURHOOD DECLINE**

- The root causes of neighbourhood decline in the UK are primarily the result of interrelated processes of economic restructuring and the decline of traditional sectors, widening social inequalities and population loss. The impact of these broader level processes varies depending on the characteristics of particular neighbourhoods and the wider local and regional context in which they are embedded.
- The majority of deprived neighbourhoods have always been low income areas, although some have previously enjoyed greater levels of prosperity (eg coastal resorts, certain inner city areas). Such differences are important to understanding the nature in which general processes have combined with local specificities to initiate and intensify spirals of decline.
- Within the operation of these long term causes, particular events are often important in triggering a marked acceleration in decline, most notably the closure of a major employer. Urban redevelopments that provide new housing opportunities outside of the area, the occurrence of civil disturbances and lawlessness, or a rapid change in the ethnic and racial composition of an area, may also act as ‘tipping-points’ for change.

## **SPIRALS OF ECONOMIC DECLINE**

- Little academic work has focused specifically on the role of economic factors within spirals of decline in deprived neighbourhoods. However, research relating to ‘vicious circles’ from housing, labour markets, private sector services and social capital, do provide valuable insights.

### **Housing markets**

- Processes of neighbourhood decay, with a focus upon private sector housing, highlight the interaction between the composition of residents in the neighbourhood, the economic conditions of the properties, and the physical condition of buildings and the neighbourhood as a whole. These models highlight the importance of private sector investment into housing for owner occupation and rent, and how the loss of investor confidence leads to reduced maintenance and investment as profits and land values fall.
- In the interaction between economic processes and the operation of the housing market a key relationship exists between income inequality, urban segregation and social exclusion. Access to 'locationally fixed' amenities (schools, parks, etc.) appears to depend on a household's position within the distribution of income of the urban area, rather than absolute income, thus pointing to the importance of income distribution as a driver of residential segregation and social exclusion.
- In the UK the high proportion of local authority or social housing stock in deprived neighbourhoods significantly influences the operation of private sector markets, and introduces different sets of factors that contribute to processes of decline related to the criteria and processes for the allocation of public sector housing.
- A falling area reputation and population loss leads to an increased outward movement by those in employment, whilst in-movers are restricted to those with least choice. There is evidence of a 'get on and get out' syndrome, whereby a person living in a deprived neighbourhood who enters employment has an increased possibility of moving out of the area. The falling proportion of those both in employment and in better paid employment further reduces neighbourhood linkages into local labour markets.

### **Labour markets**

- Concentrations of unemployment are principally the result of person-related factors and differences in population mix. They persist due to recurring patterns of job loss, often sectorally rooted, and through past experiences of unemployment actively promoting concentration.
- The geography of concentrated unemployment only partially reflects that of job loss and job growth. Vicious circles that link local unemployment to local social outcomes (through factors such as access to job information, short-term jobs creating interrupted work histories, health deterioration, family fragmentation, and educational underachievement), act to further reduce the employment prospects of residents in the short and longer term.

### **Private sector services**

- The withdrawal of private sector services from deprived neighbourhoods occurs via a mutually reinforcing negative cycle, involving the declining quality of the local environment, falling levels of demand and active area discrimination. Low levels of private sector services make a neighbourhood less attractive to live in, thus further destabilising communities.

- For retail activity in particular, the appearance and nature of the local environment is a critical factor that often plays a key role in their withdrawal from deprived neighbourhoods. Furthermore, low and declining levels of demand lead to a fall in the level of service provision and reduced competition, often resulting in poorer quality and higher cost services.

### **Social capital**

- Change in the resident population influences the extent and strengths of social ties and networks. Although existing residents may have sets of institutional and social ties built up through interaction over time and through shared norms, incoming populations are often more transient, with fewer local networks and little commitment to the neighbourhood. Population succession therefore leads to increased fragmentation of the resident population and can contribute to the weakening of existing stocks of local social capital.

## **ARRESTING AND REVERSING DECLINE**

- Descriptions of spirals of decline within deprived neighbourhoods commonly draw attention to the operation of wider processes and the need for policy responses at that level.
- A focus on the economic dimension of spirals of decline brings to the fore the importance of certain factors and the need to deal with them in an integrated manner that is informed by an understanding of the particularities of any given locality.

### **Fixing and attracting population**

- Greater policy attention is required to the retention and attraction of residents to less desirable urban areas. To date, most policies have sought to develop more socially mixed and integrated neighbourhoods via physical planning, improving the general quality of the environment, and seeking to encourage social integration and community cohesion. There is potential for the greater use of fiscal incentives to attract individuals, although it remains difficult to fundamentally change population location patterns.
- Doubts remain as to how effectively socially marginalised peoples can be drawn into local networks and develop shared values, networks, and a sense of belonging within mixed ethnic neighbourhoods.
- Seeking to fix sections of the population moving out of deprived areas requires clear understanding of the interface between local processes of economic and housing market change. The complexity of this relationship suggests the importance of clear analysis of local conditions and the importance of developing locally sensitive policies.
- Policies that improve employability and access to jobs of those living within a deprived area can actually promote selective mobility. Therefore, developing the skills of individuals needs to be undertaken alongside policies that build up local communal resources and networks which will be retained even after selective out-migration occurs.

## **TACKLING LOCALISED WORKLESSNESS**

- Targeting job creation at areas of unemployment concentration has few advantages over a more regional approach, as rates of leakage out of the local area are extremely high. Instead attention should focus upon interventions that help disadvantaged local residents to compete successfully for jobs either inside or outside of the areas.
- Concentrations of unemployment can only be removed by a combination of supply-side measures targeted at all the links in local processes that reproduce them, and sustained full-employment in the relevant region. The competitive disadvantage of local residents of deprived neighbourhoods within the labour market is the result of previous experiences of unemployment compounded by various social forces, and it is these factors that need to be addressed in an integrated and comprehensive manner within deprived areas.

## **RETAINING AND EXPANDING PRIVATE SECTOR SERVICES**

- Area stigma is an important factor shaping private sector investment decisions. The importance of a greater emphasis upon the improvement of 'place-image' throughout neighbourhood renewal programmes is emphasised by research findings.
- In seeking to retain retail provision on a long term basis, attention needs to be paid to the retail market place within the overall framework of wider local and sub-regional retail activity, alongside resident involvement in identifying needs and aspirations.
- A combination of top-down and bottom-up initiatives to tackle service exclusion involves national regulatory responses, alternative community provision, persuading major service providers to reinvest in over abandoned areas, and tackling 'compound' service exclusion holistically.
- The model of 'underserved markets' in many deprived areas, especially in the retail sector, suggests that by providing a competitive offering, outlets can increase local sales, local jobs and consumer demand in a virtuous circle. US experiences demonstrate that attracting in private sector reinvestment is possible and important to the regeneration of neglected inner city areas, but also reveal the dangers of displacing former residents via processes of gentrification.

## **IDENTIFYING AREAS ON THE BRINK OF DECLINE**

- Despite the potential importance for policy development, there is little academic work to date on areas on the brink of economic decline other than some recent work on the longer term sustainability of the suburbs. There is an opportunity for more research on this issue.

## Case Study Findings

### CASE STUDY AREAS

- The methodology included the analysis of five case study local economies defined at the local authority district scale and selected to cover a range of deprived area types within different regional contexts. The case studies comprised Sunderland (in the North East region), Oldham (in the North West region), Mansfield (in the East Midlands region), Brighton and Hove (in the South East region) and Newham (in London).
- As well as examining economic change at the district scale, the case studies focused upon a number of deprived neighbourhoods, defined at ward level and identified via the Index of Multiple Deprivation. These provided insights into the particularities of neighbourhoods and differences between them in terms of their economic contexts and their dynamics of change.
- The analysis of each of the case study local economies comprised the collection and review of locally produced economic development related reports, the analysis of government databases relating to the structure, evolution and characteristics of the local economy, and interviews with 'key actors' involved in economic development and neighbourhood renewal.

### ECONOMIC FEATURES OF LOCAL ECONOMIES AND THEIR DEPRIVED NEIGHBOURHOODS

- The case study areas reveal considerable similarities in their economic characteristics and recent evolution, and important differences that are reflected in the nature and scale of deprivation within the most deprived areas. They range significantly from Newham which was ranked as the fifth worst local authority district on the basis of the Index of Multiple Deprivation in 2000, to Brighton and Hove which was ranked 95th.

#### Population characteristics

- There are important variations in ethnicity and age structure. Newham is by far the most ethnically diverse local economy (61 per cent non-white) whilst Sunderland and Mansfield have predominantly white populations.
- There is a strong contrast in population change between the older industrial areas which have experienced population decline, and areas integrated into the London and South East labour market which have seen strong above average population growth.
- Population changes within the deprived neighbourhoods are complex and require careful interpretation. Key characteristics of deprived areas are both the presence of a relatively long term, ageing, stable but declining population, and a younger, growing and more transient population. Certain deprived areas are characterised predominantly by one or other of these elements, whilst others simultaneously contain elements of both.



### **Sectoral change**

- The local economies provide clear evidence of broader processes of sectoral change. The ongoing consequences of the long-term decline of mining and manufacturing are central to understanding the economic problems of all areas. The decline of manufacturing continues to be central to recent job losses in Oldham, Mansfield and Sunderland.
- All local economies achieved net job growth over the 1997-2002 period, although the rate of growth varies widely from 15.9 per cent in the case of Brighton and Hove to 2.8 per cent and 2.9 per cent in the cases of Newham and Oldham respectively. Job growth has been predominantly in low skill, low paid service sector jobs notably in the distribution and catering sectors, public service employment and other business activities.

### **Labour markets**

- Labour markets of deprived areas share a number of common characteristics comprising relatively high levels of unemployment and worklessness, low rates of economic activity and employment, and low levels of household income and wages.
- The official rate of unemployment within the local economies remains above the national average, although this varies between areas relatively close to the 2001 national average of 3.3 per cent (eg Brighton and Oldham), and Newham which is twice the national average. Unemployment rates in the most deprived wards are commonly twice the local average, typically between 7.0-8.5 per cent, and rates of long term unemployment are also significantly higher. There are significant variations in unemployment rates between ethnic groups where these are present.
- Current unemployment rates are significantly lower than the high rates characteristic of the 1980s and early 1990s, and have also fallen significantly within deprived wards. This has resulted in a tightening in the labour market and shortages of certain types of employees even within less prosperous local economies.
- Despite relatively low levels of official unemployment, there is also significant 'hidden' unemployment, particularly with regard to neighbourhoods within older industrial areas, where a high proportion are claiming other benefits such as invalidity benefit.
- Economic activity rates within the case study areas remain below the national average, significantly so in the cases of Newham, Sunderland and Mansfield, and have witnessed above average decline between 1991-2001. Economic activity rates are significantly lower in the most deprived wards. Similar trends are evident with respect to employment rates.
- Relatively high levels of labour market inactivity are evident within all local economies, but the reasons for this vary significantly from relatively high percentages of students (Newham and Brighton), the permanently sick and disabled (Sunderland, Oldham and Mansfield) and those looking after the home and family (Newham and Oldham).

- Average weekly pay in the case study local economies is significantly below those of the regions in which they are located. This is most acute in the highest paid region of London and the South East. Income from benefits including income support and job seekers allowances are above the national average, and up to twice the local average in deprived wards.

### **Education and Skills**

- A fundamental economic characteristic of the local economies is the relatively low level of education and skills of the workforce. In the older industrial areas of Sunderland, Oldham and Mansfield there is a high proportion of the population with no qualifications (37-38 per cent), well above the national average of 29 per cent. The exception to this is Brighton and Hove, which has a relatively skilled population by national standards. Within deprived wards the problem of low educational and skill levels is particularly acute, with over 50 per cent of the population having no qualifications in a number of the worst performing wards.

### **Entrepreneurship and business start-ups**

- There is a sharp north-south difference between the five areas with respect to growth in the numbers of businesses and new business formation rates. The stock of businesses in both Brighton and Hove and Newham grew significantly faster than the national average over the 1994-2003 period, Mansfield performed in line with the national average, and Sunderland and Oldham performed significantly worse.

### **Informal economic activity**

- Although data is limited, the important contribution of informal activity to residents 'getting by' on low incomes within deprived neighbourhoods is evident. This involves combining informal economic activity, both paid and unpaid, with income from formal employment and state benefits.

### **Role of the public sector**

- The public sector is a major and growing source of employment across all the local economies, principally within the areas of health, education and public administration. Within deprived neighbourhoods the public sector is particularly important as a source of transfer payments, and as a source of semi skilled service employment.

## **RELATIONSHIP OF THE LOCAL ECONOMY TO WIDER SPATIAL SCALES**

- The case studies demonstrate how the economic problems which beset deprived local economies are rooted within processes operating at wider sub-regional, regional, national and global scales. Economic problems arise out of particular sectoral decline relating to coal-mining, shipbuilding, textiles and light manufacturing industry, with specialist regional, sub-regional, and local economies suffering dramatic losses in jobs and investment.
- The competitive basis of the local economies is rooted within these wider processes of change. For example, in the northern case study areas long term structural decline of traditional industries has produced economies

with a number of common weaknesses in terms of low levels of productivity, economic activity, income, wages, skills and education. Aspects of economic dynamism in these areas also relate to features of the wider sub-regional economy.

- The economic contexts of Brighton and Newham are different and provide examples of the persistence of concentrations of deprivation within economically successful regions where job growth has been strong.

### **Economic competitiveness and social cohesion**

- The case studies provide unequivocal evidence of the link between wider processes of economic restructuring and resulting problems of social deprivation and exclusion. However, the impacts that concentrated deprivation have upon processes of economic growth remains less clear.
- The extent to which such areas contribute positively to the wider economic growth dynamic remains poorly understood. For example, deprived neighbourhoods in Newham perform an economic role as reception areas for cheap immigrant labour within a rapidly growing global city, yet how precisely this contributes to the wider competitiveness of this urban economy is poorly specified.
- The negative impact of the presence of deprived localities appears most significant in terms of a poor image deterring inward investment and new residents, although there is little clear cut evidence to substantiate this. With rising levels of employment and skills shortages in all areas, the potential role of deprived areas with relatively high levels of unemployment becomes increasingly pertinent to employers complaining of local labour market shortages.

### **Deprived neighbourhoods within the local economy**

- Despite economic commonalities, recognition of the differences between local economies within which deprived neighbourhoods are located is highly important for policy responses and delivery. Hence the work culture associated with coal-mining in Mansfield is radically different to the labour market characteristics of a highly ethnically diverse and relatively youthful population in Newham.
- Significant differences between deprived neighbourhoods within the same local economy are also evident. For example, in East Brighton, North Moulsecoomb on the outskirts of the city has a relatively stable population of long established families, whilst Saunders Park, closer to the city centre has a more transient and diverse population.

### **Spatial concentrations of deprivation and spirals of decline**

- The case studies reveal that whilst the causes of deprivation are largely rooted within economic decline and restructuring, the processes creating highly localised deprivation are largely driven by the operation of housing markets. A complex interface exists between wider economic problems affecting the local/sub-regional area, and the operation of sorting mechanisms in the private and public sector housing markets sometimes exacerbated by other local housing renewal programmes.

- Central to processes of neighbourhood decline is the loss of those in employment and with higher levels of skills and education. This not only removes wealth from the neighbourhood, but also important local connections to the worlds of work and education and potential role models. The remaining population becomes more fragmented, often with tensions between the longer term existing population and an incoming younger and more transient population.
- The local population becomes increasingly trapped within low grade housing accommodation for which there is little demand, and limited chances of moving out given the problems of securing reasonably paid employment. In the wider South East rapidly rising house prices and shortages of affordable housing create particular problems in limiting the mobility of the least well off.

### **Neighbourhood effects**

- Place based neighbourhood effects that compound disadvantage were evident with regard to issues of relative physical isolation, the poor quality of the built environment, levels of environmental pollution and the poor quality and absence of private services.
- People based area effects included the presence of particular attitudes and perceptions towards employment and education within many deprived neighbourhoods. These were characterised by reduced expectations and aspirations of employment and an acceptance of 'getting by' via benefits and unpaid and paid informal work.
- Concentrations of deprivation contributed further to the barriers of entry to formal employment. Factors here included the lack of social networks to find jobs, particularly via informal networks; a lack of contact with the world of work leading to the poor development of interview and work skills; and a lack of willingness to travel-to-work beyond the locality reflecting spatially restricted social networks. Other barriers reflected practical problems relating to limited flexibility and high transport cost in relation to low wages, and an absence in some places of good, reliable and affordable public transport.
- Area stigmatisation and discrimination was routinely reported, although assembling evidence as to whether this translated into active postcode discrimination was beyond the scope of this analysis. There was some evidence that the tightening of labour markets was reducing the scope of employers to exercise such discrimination.
- Some notable differences were apparent between neighbourhoods with respect to local social capital formation. More transient populations tended to exhibit less neighbourhood commitment compared to neighbourhoods where there was a presence of longer term residents who were commonly the source of neighbourhood leadership.

## **LEVELS OF INTERVENTION AND GOVERNANCE OF ECONOMIC POLICY**

### **Neighbourhoods and local economic policy**

- Even the most localised labour markets for formal employment operated at a larger scale than that of the neighbourhood. Those activities that predominantly operate at the neighbourhood level (eg unpaid and paid informal work; local service enterprises) also demonstrated connections to wider economic relationships.
- Economic policies operating at the neighbourhood level were limited and not afforded priority within renewal strategies, which instead focused upon 'crime and grime' initiatives. This reflected a lack of priority to neighbourhood economic initiatives under current policies, as well as the lack of priority assigned to such issues by the local community.
- Enterprise initiatives supporting small business start-ups tended to be organised at the level of the local or sub-regional economy with clear recognition that residents from deprived neighbourhoods had limited skills and resources with which to enter self-employment or business start-ups.
- Examples of community economic development initiatives in the form of credit unions, community enterprises and the formalisation of informal economic activities were apparent. However, there was important variation between localities in these types of activities, reflecting different local social and political traditions and the work of local institutions.
- Current policies focus upon getting residents of deprived neighbourhoods into formal employment within the wider labour market. Local initiatives here included those that sought to improve employability through the development of 'soft skills', basic skills and support for childcare provision; actively linked residents of deprived areas to new job opportunities (eg subsidised public transport); developed skills in areas of employment growth (eg construction); and improved the education and career aspirations of young people (eg through improving basic school education, mentoring and sponsorship programmes).
- These initiatives require co-ordination between the neighbourhood, local and sub-regional levels, and worked better when the neighbourhood was being used as the delivery scale for these wider employment policies. Flexible neighbourhood delivery is necessary to reach excluded groups given the existence of low levels of mobility, the lack of connections with the world of employment and a lack of trust of state institutions.

### **The local and sub-regional economy**

- For deprived neighbourhoods a policy focus upon improving the overall performance of the local/sub-regional economy raises issues concerning the overall level of demand for labour within the local labour market, and the extent to which residents of deprived neighbourhoods benefit from any employment growth.

- Certain interventions have been developed which seek to ensure that the benefits of economic growth flow to deprived neighbourhoods (eg via schemes preparing and guaranteeing interviews for newly created jobs in larger local developments). Such schemes require strong integration between actors at sub-regional/local and neighbourhood levels to be effective, and must exercise care in how they discriminate between disadvantaged groups within the local labour market.
- Local and sub-regional/regional economic strategies all focus upon the development of a high skill and high wage economy. The creation of higher skill jobs often located in new growth sites are difficult to access for poorly qualified residents of deprived areas. There is little attention to the role of lower paid and less skilled jobs even though these are the most relevant to the needs of residents of deprived neighbourhoods.
- The low skill, low paid jobs which are on offer often hold little attraction to individuals marginalised from the labour market, and provide few incentives to move off of state benefits. Consequently more attention needs to be paid to the issue of supply and demand of low and semi-skilled jobs within these local economies.

### **Governance and delivery arrangements**

- The case studies reveal that the current governance arrangements for linking the problems of deprived neighbourhoods into wider local, sub-regional and regional development programmes are relatively weak and variable in their effectiveness.
- Regional and sub-regional strategies generally say little or nothing about how they will operate to support the needs of deprived neighbourhoods. The emphasis of the regional economic growth agenda upon issues of competitiveness, innovation and enterprise creates difficulties of integration with the social exclusion dimension of neighbourhood renewal.
- Neighbourhood based organisations have a limited ability to communicate their needs upwards, whilst top-down funds do not always reach those most in need. Neighbourhood based organisations feel marginalised and distant from strategy making and decision making relating to local/regional economic development.
- Local Strategic Partnerships (LSPs) have, in the majority of cases, not developed a strong economic development agenda in comparison to other areas of activity such as crime and the local environment. Links with other local economic institutions are patchy and weakly developed.
- There is a major weakness in terms of structures at the sub-regional level which is particularly important with regard to labour market policy. Whilst the Regional Development Agencies (RDAs) and the LSPs are now relatively well established, sub-regional level organisations are more variable in the scope of their activity and their level of institutional development.

- Central government policies and programmes appear more likely to be effective if they are owned and delivered close to the ground by trusted actors within deprived neighbourhoods, and with the possibility of a degree of flexibility to adapt to specific local conditions.

## Issues for Policy Development

- The evidence assembled from the literature review and analysis of case study local economies permits the identification of a number of issues with regard to policy development relating to the economic development of deprived neighbourhoods.

### **INTEGRATION OF DEPRIVED NEIGHBOURHOODS INTO WIDER ECONOMIC DEVELOPMENT STRATEGY AND DELIVERY**

- Recognition that deprived neighbourhoods are part of the wider economic system makes it essential that their economic needs are integrated within economic development strategies operating at the wider local, sub-regional and regional spatial scales.
- Regional, sub-regional and local economic development strategies need to directly address the needs of deprived neighbourhoods. This requires attention to the recurrent divide between strategy formulation at higher spatial levels (region or sub-region) and localised delivery, to ensure those working in deprived neighbourhoods can actively participate in strategy and policy development.
- Institutionally, such an approach requires a stronger orientation of LSPs towards economic development issues and the development of stronger sub-regional partnerships and strategies. The latter is particularly significant given the importance of the sub-regional scale in relation to the labour market in terms of both supply and demand side issues.

#### **Labour market policy**

- Employment remains fundamental to the economic development of deprived neighbourhoods. In terms of getting residents from deprived neighbourhoods into employment, much greater attention needs to be paid to the types of employment that are being created within the local economy.
- Low wage and unstable employment reinforces low expectations and aspirations, and provides few incentives to move off of benefits. The generation of a wider range of jobs, particularly semi-skilled jobs, and opportunities for ongoing training and career progression provides important role models and creates new entry points. Employers have an important role here, notably public sector employers who are a major source of employment in deprived areas.
- Integration back into the world of work becomes important from a young age in areas where aspirations and expectations are low due to the prevalence of worklessness. Work experience programmes, schemes linking

local schools and employers, and the use of intermediate labour markets (ILMs) are potentially important here.

### **Neighbourhood economic initiatives**

- Although neighbourhood level economic initiatives are unable to create large scale employment opportunities, bottom-up initiatives that seek to tackle problems alongside the work of central government programmes are important. Such initiatives develop local capacities and encourage mutual aid and self-help at the level of communities and individuals, and develop locally rooted structures. Evaluation of such initiatives should be in terms of their role in promoting a better quality of everyday life, social inclusion and political participation rather than in narrow economic terms.
- The strong emphasis within the current policy agenda upon formal employment as the route out of poverty has led to a relative neglect of a range of community based economic initiatives (eg credit unions, time banks, community enterprises, intermediate labour markets, etc.), and the role of informal work in managing and surviving within low income areas.
- The negative impact of the stigmatisation of deprived areas for residents and in discouraging private sector investment, suggests more attention should be paid to the process of altering the internal and external place-images as part of the neighbourhood renewal process.

### **Neighbourhood delivery and ownership**

- Main government funding programmes are of central importance to deprived neighbourhoods. In seeking to encourage marginalised groups to engage with formal employment, delivery needs to be adaptable and sensitive to local needs of residents and employers, and delivered by trusted and credible organisations. Forms of neighbourhood delivery, working with and through local community based organisations, are likely to be the most effective in promoting employment and enterprise within deprived areas.

### **Geographies of local economic development**

- The sites of new job creation are often not easily accessible to residents of deprived areas, particularly given their limited mobility. This suggests the importance of initiatives that make new jobs more accessible through cheap and reliable public transport provision, childcare provision and training. Where development sites do exist close to, or within deprived neighbourhoods, these provide particular opportunities.
- The changing local geography of economic activity and employment indicates that, for certain neighbourhoods, economic decline is a process to be managed rather than reversed.

### **Spirals of decline**

- The loss of the most economically mobile elements of the population is a central issue of spirals of decline in deprived neighbourhoods. Of importance here is the need for early and integrated intervention before environmental and service quality declines to a tipping point where the economically active move out 'en masse'.



- Given the importance of residential sorting mechanisms to the creation of concentrated deprivation, there remains a need for stronger integration of housing developments and housing policy with processes of local economic development. This involves greater sensitivity towards the possible impacts upon declining neighbourhoods of new developments, and active consideration of how to maintain a stronger social mix within declining areas.

## Summary of Part Two (Case Studies)

### CASE STUDY 1

#### Sunderland

##### 1.1 DYNAMICS OF THE SUNDERLAND ECONOMY

- Sunderland is an important industrial and business city within the North East region, historically associated with coal-mining, shipbuilding, engineering, and glass-making. Despite several successes in attracting inward investment, Sunderland continues to have some of the most deprived communities within the North East, particularly in the inner city and riverside areas.
- Although subject to ongoing decline, manufacturing's share of total employment is above the national average (21.9 per cent compared with 15.7 per cent). The service sector is dominated by retail/wholesale (17.3 per cent of total employment), finance/business (14.3 per cent), health/social work (11.3 per cent) and transport/communications (6.1 per cent).
- Between 1997 and 2002, the number of jobs in the Sunderland economy increased by 6,000, an increase of 5.9 per cent. The sectors experiencing employment decline were mainly in manufacturing, with the clothing, electronic goods and electrical machinery sectors each shedding around 1,000 jobs over the five year period. In contrast, almost 2,000 extra jobs were created in motor vehicle manufacture and over 1,000 in rubber and plastic goods manufacture and publishing and printing taken together. The largest increase in employment occurred in the education sector, with nearly 3,000 extra jobs.
- The unemployment rate in Sunderland fell from 7.1 per cent of the 16-74 aged population in 1991 to 4.8 per cent in 2001, although ward unemployment rates ranged from 2.2 per cent to 8.0 per cent in 2001. The

Claimant Count unemployment rate for Sunderland in July 2004 was close to the North East region average (3.0 per cent compared to 2.9 per cent).

- There is a significant proportion of long-term unemployed (37 per cent of total unemployed), compared with 30 per cent in England as a whole. In some wards, more than 40 per cent of the unemployed are 'long-term'.
- Sunderland's employment rate in 2001-02 was 66.1 per cent, considerably below the national rate of 75.0 per cent. The employment rate for those aged over 50 was especially low, 50.2 per cent, compared to 69.1 per cent nationally.
- A much higher proportion of Sunderland's economically inactive are permanently sick or disabled than is the case nationally (26.3 per cent compared to 16.0 per cent), largely attributable to the legacy of coal-mining and shipbuilding.
- Sunderland's workforce is characterised by relatively low skills and education, with 36.9 per cent of residents aged 16-74 having no qualifications in 2001 (compared with 28.9 per cent nationally) and exceeding 40 per cent in ten wards.
- One of the main weaknesses of the Sunderland economy is the low rate of new business formation. The number of VAT registrations per 10,000 adult population is one of the lowest in England (an average of 18.2 over the 1997-98 to 2002-03 period, compared to a national average of 40.7).

## 1.2 ECONOMIC PROBLEMS OF DEPRIVED NEIGHBOURHOODS

- In terms of deprivation, Sunderland is ranked 18th overall in England and 8th in terms of the employment domain. There are 11 wards ranked within the 10 per cent most deprived wards nationally, and Southwick is ranked 55th nationally.
- Interviewees directly involved in efforts to assist deprived neighbourhoods described them as having:
  - high levels of both registered unemployment and hidden unemployment
  - most employed residents being in unskilled part-time employment with many having two or three jobs in order to make ends meet
  - high levels of indebtedness
  - low levels of educational achievement
  - very low car ownership, which restricts mobility and choice in the job market

- a negative perception of deprived neighbourhoods by employers inhibiting access to employment outside the area
- low aspirations and related ‘cultural barriers’ towards education and skills awareness and attainment

### **1.3 CASE STUDY OF A DEPRIVED NEIGHBOURHOOD: HENDON AND EAST END**

- Interviews with those with first hand knowledge of Hendon and East End drew attention to the following:
  - although individuals may have benefited, there has been little improvement in the community over the last 25 years
  - many people choose to remain unemployed rather than taking work perceived to be insecure, poorly paid and of low quality
  - investment attracted to Sunderland has had little perceptible impact on the fortunes of deprived communities
  - some local employers are showing a willingness to become engaged in tackling the problems
  - a high level of informal economic activity and working

### **1.4 CO-ORDINATION AND INTEGRATION OF POLICY STRATEGIES AND ECONOMIC INITIATIVES**

- Sunderland has had a sustained commitment to local economic development and regeneration policies over several decades and has been a beneficiary of virtually all government and EU programmes targeted at deprived areas.
- The RDA, ‘One NorthEast’, mainly focuses on economic development at the regional and sub-regional scales rather than at the local scale. Some interviewees expressed concern about what they regarded as the low priority given by the RDA to tackling the problems facing deprived localities in the region.
- There is a strong sub-regional level co-operation in the form of the Tyne and Wear Partnership, which has come about partly because of the decision of One NorthEast to adopt a sub-regional model of organisation. However, the sub-regional scale does not fit well with the localised scale that the voluntary and community sector is used to.
- Where the Learning and Skills Council (LSC) Tyne & Wear has discretion over its spending, the focus is primarily on particular disadvantaged groups (eg refugees, ethnic minorities, those with disabilities) rather than on deprived areas (although the two invariably coincide).

- Business Link Tyne & Wear operates at the sub-regional level and does not target its services at particular localities, the view being that most businesses require the same kind of assistance wherever they are located.
- Sunderland City Council has a Business and Investment Team and a Development, Housing, and Regeneration Team. The Council is fairly unique in having its own £1m grant fund which it uses to attract inward investment and promote indigenous business development.
- EU Structural Funds (via Sunderland having Objective 2 status) has proved to be an important source of funding available to the Council for various grass roots, local economic development initiatives. Using Single Regeneration Budget (SRB) matched with EU funds, the Council (in partnership with the Careers Service and LSC) has developed its own 'Jobs Linkage' programme, which aims to provide a personalised counselling and job support service.
- While the emphasis of the Tyne and Wear Partnership appears to be on business-led regeneration and economic development issues, that of the LSP is more concerned with issues of worklessness and access to employment. This could easily become a growing divide unless ways are found of forging better links between economic and social regeneration.
- Some interviewees expressed concern about the danger of agencies 'working in silos', and that if capital projects are not sufficiently linked into the 'social agenda', efforts could be wasted.
- The East End and Hendon New Deal for Communities (NDC) has £54m from the government to spend on community regeneration between 2001-11. However, despite their common concern with neighbourhood renewal, there appeared to be little co-ordination and joint working between the NDC and the LSP.

The following Figures (called Policy Maps) summarise the complex web of linkages relevant to economic development in the area. Figure 1a illustrates the Enterprise and Business policy area; Figure 1b looks at Employment and Skills, and Figure 1c shows the main policy linkages in the field of Regeneration. Although these links and titles of organisations change over time, and in a few cases may have moved-on since the research was undertaken, they broadly remain current.



Figure 1b: Sunderland Local Economic Development Policy Map

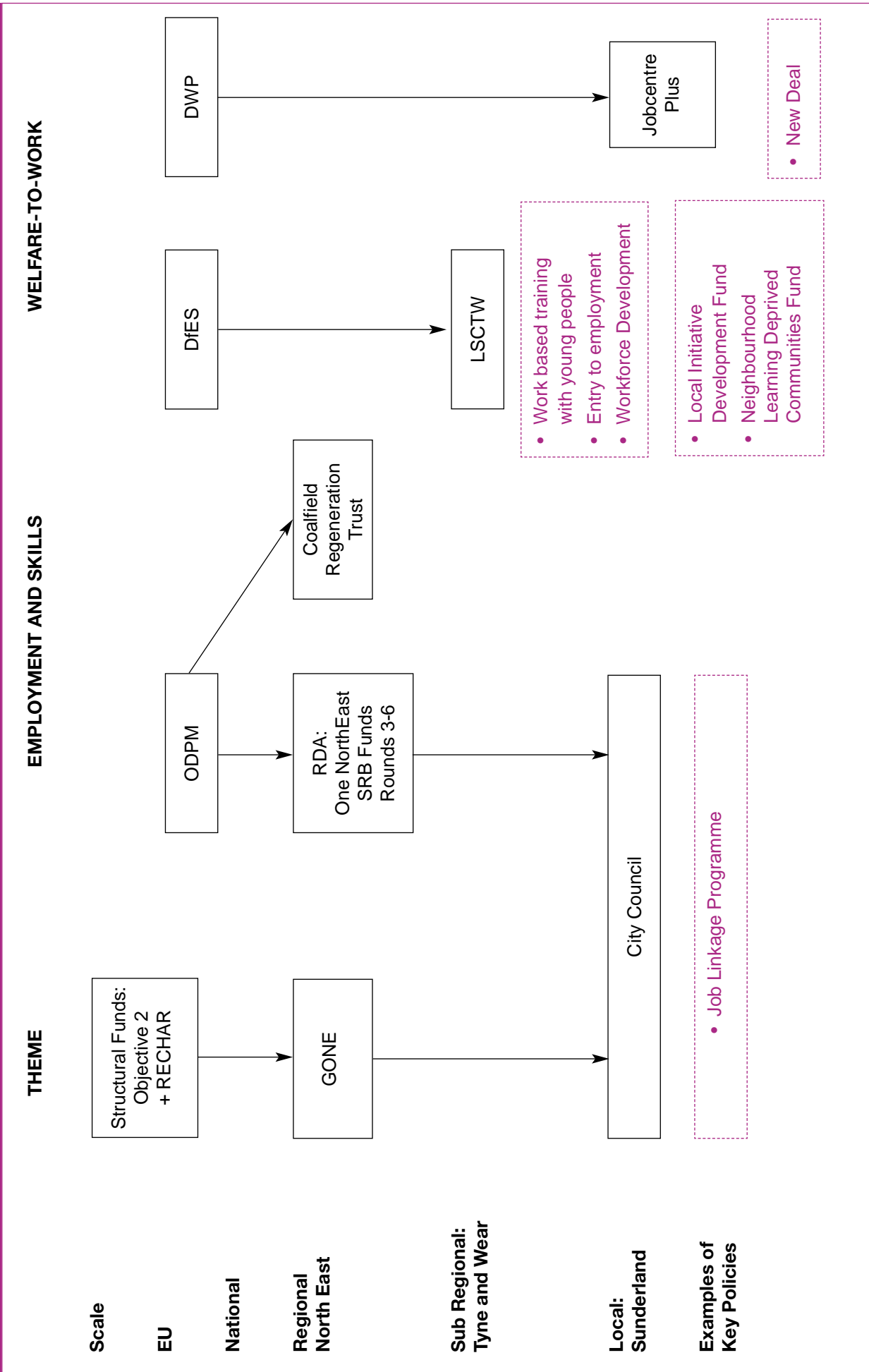

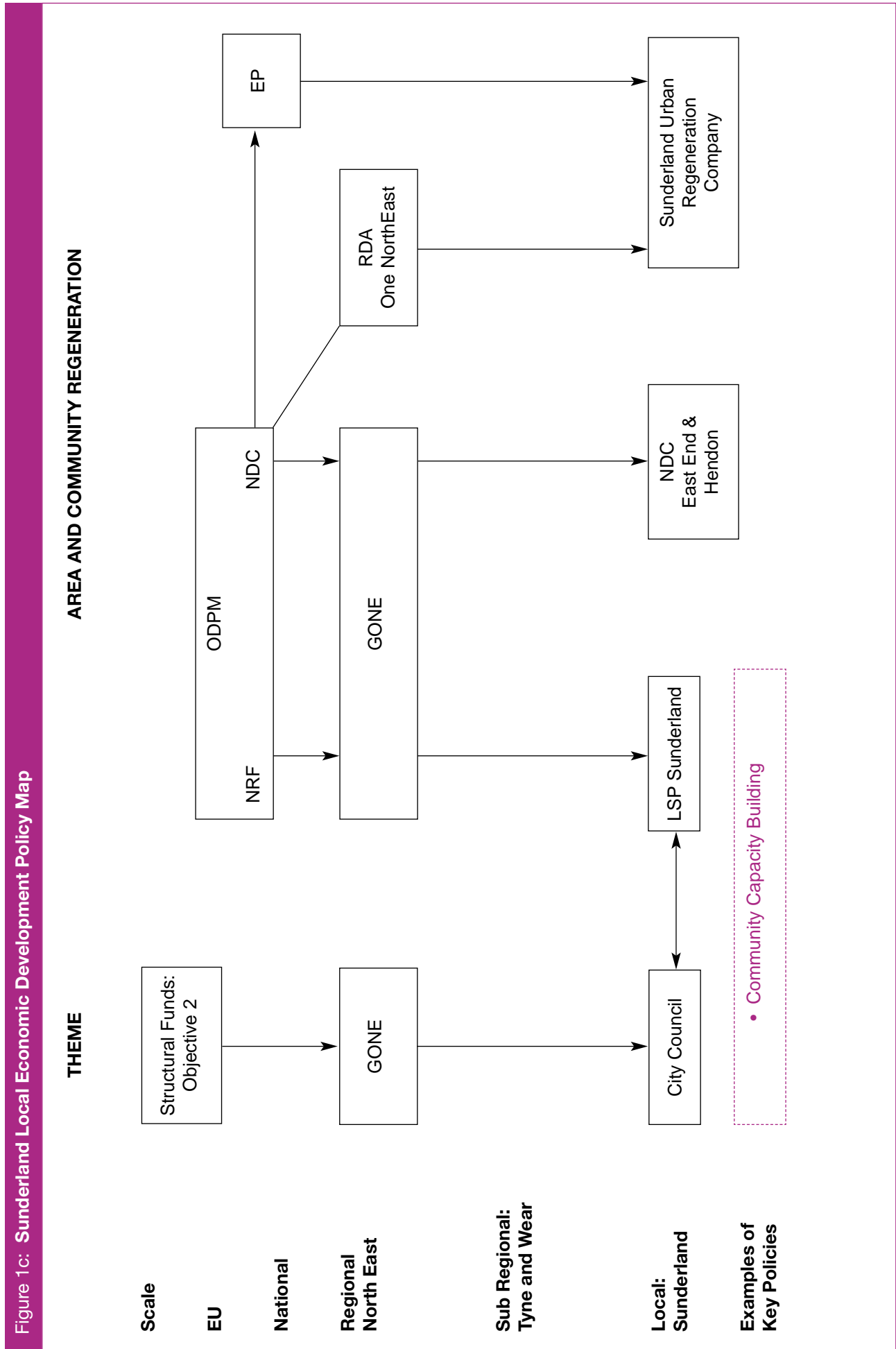

## CASE STUDY 2

### Oldham

#### 2.1 DYNAMICS OF THE OLDHAM LOCAL ECONOMY

- Oldham, on the northern side of the Greater Manchester conurbation, was traditionally associated with the cotton textile industry, although its present economy is closely intertwined with that of the rest of the urban sub-region. It remains a largely working class town, with a rapidly expanding ethnic minority population, mainly Asian/Asian British.
- The employment of Oldham residents is mainly in distribution, hotels and restaurants (24.9 per cent), public administration, education and health (26.9 per cent) and manufacturing (20.3 per cent), the latter accounting for a greater share of employment than it does nationally.
- Overall, the number of jobs in Oldham increased by 2.9 per cent over the 1997-2002 period, the decline in the manufacturing sectors being more than offset by the growth in a range of service sectors. Nine of the ten largest reductions in employment were in manufacturing sectors, with three sectors each shedding more than 1,000 jobs over this period: manufacture of machinery and equipment, textiles, and medical instruments.
- Over 2,000 additional jobs were created in retailing, together with 1,500 in the wholesale trade. More than 3,000 jobs have been created in the public services.
- On a number of indicators the Oldham economy continues to under-perform. For example, there has been no growth in the number of VAT registered businesses and the VAT registration rate over the 1997-98 to 2002-03 period averaged 28.7 registrations per 10,000 adult population compared to a national average rate of 40.7. A recent competitive index shows Oldham to rank second lowest of all Greater Manchester districts.
- The unemployment rate in Oldham fell from 6.0 per cent of the 16-74 aged population in 1991 to 3.7 per cent in 2001, although ward unemployment rates ranged from 1.9 per cent to 7.2 per cent in 2001. The Claimant Count unemployment rate for Oldham in July 2004 was 2.9 per cent, the same as the North West regional average.
- Oldham's employment rate in 2001-02 was 72.7 per cent, slightly below the national rate of 75.0 per cent. However, the employment rate for the ethnic minority population was especially low, 37.6 per cent, compared to 57.4 per cent for ethnic minorities nationally.
- Oldham is a relatively low wage economy, with average gross weekly earnings significantly below the regional and Greater Manchester averages, as well as having a higher proportion of its population on income support.



- An above average proportion of the working age population are without qualifications (37.7 per cent compared with 28.9 per cent nationally in 2001), reaching over 50 per cent in four wards, and a much lower proportion have level 4/5 qualifications (12.9 per cent compared with 19.9 per cent).
- A key weakness of Oldham's economy is that it attracts many jobs that are low skill and low paid, many of which are seasonal in character, including in food, clothing and 'home shopping'. This reinforces low aspirations and low educational attainment, offering little incentive or opportunity for advancement and 'upskilling'.
- Although there is potential for private sector investment, given the availability of land and good transport infrastructure, there are difficulties in competing with eight other towns of similar size in the urban sub-region for the limited supply of inward investment projects.
- Oldham Local Strategic Partnership and the Northwest Development Agency have recently commissioned a large-scale study to develop a strategic vision for the renaissance of the Borough, which aims to be inclusive, encompassing its people and communities, economy, transport, housing market and physical environment.

## **2.2 CHARACTERISTICS OF DEPRIVED NEIGHBOURHOODS**

- Just over a third of wards in Oldham are within the 10 per cent most deprived nationally, with three wards being amongst the 100 most deprived wards.
- The ethnic minority population is heavily concentrated in several of the most deprived wards. The racial tensions in Oldham, culminating in the civil unrest of 2001, are generally thought to have been partly triggered by the perception that some of the deprived neighbourhoods with large Asian communities had received a disproportionate share of the public resources targeted at regeneration. The latest regeneration initiatives, such as the NDC, have therefore sought not to favour particular ethnic groups.
- There are high levels of economic inactivity in the deprived wards, much of it related to the high proportion of the population on sickness and disability benefits.
- Interviewees with first hand knowledge of deprived neighbourhoods emphasised how low aspirations and low skill levels combine to restrict economic potential, and that it was difficult to break this cycle.
- Ethnic minorities in particular tend to rely on word-of-mouth from family or extended family members for finding out about employment opportunities, leading to ethnic segregation in some workplaces.

- There is a reluctance to travel far to work because of care commitments, particularly in ethnic minority communities, and also because of concerns over safety outside of the local neighbourhood.

## **2.3 CASE STUDY OF DEPRIVED NEIGHBOURHOODS:**

### **Hathershaw and Fitton Hill**

- The NDC programme focuses on Hathershaw and Fitton Hill, with £87m of Government, EU, and Lottery funding to spend on regeneration of the area between 2002 and 2012. Interviewees with first hand knowledge of the area drew attention to:
  - the very poor condition of the housing stock in Hathershaw, resulting in the area being targeted for Housing Market Renewal funding
  - much of the housing is owned by private landlords, with many empty properties which are unsellable or unlettable
  - many local shops have closed and are still boarded up
  - Fitton Hill was a council housing estate built in the late 1960s which is now owned and managed by a housing association
  - the resident population, which is predominantly white, is characterised by high unemployment, low educational attainment, high teenage pregnancy, drugs related problems, and high crime levels
  - many NDC initiatives are aimed at confidence building and raising educational expectations and skills levels
  - other initiatives are focusing on getting young people into work, particularly in the construction sector where there are shortages of skilled workers

## **2.4 CO-ORDINATION AND INTEGRATION OF POLICY STRATEGIES AND ECONOMIC INITIATIVES**

- Following the civil disturbances of 2001 and the subsequent public enquiry, there is now a concerted effort amongst local economic development agencies to take a borough-wide view and to be as inclusive as possible.
- Oldham Borough Council has a 'hands-on' approach to local economic development, being responsible for the direct delivery of business support, town centre improvements, and industrial estates. Following a recent structural reorganisation, these activities are now part of a larger regeneration department with a wider remit including Housing Market Renewal Fund pathfinder work.

- At the sub-regional scale, the geographical boundaries of various organisations and partnerships involved in local economic development and regeneration do not coincide, and their responsibilities do not naturally fit together. From a borough level perspective, this leads to confusion and makes integration difficult.
- The Northwest Development Agency (NWDA)'s Single Programme funds have been used to assist the purchase of large sites for redevelopment in and around Oldham, with a view to attracting key employers to them.
- Most of the LSC Greater Manchester's funds are ring fenced, but the Local Initiative Development Fund has provided some discretionary funding for voluntary sector projects concerned with basic skills training and learning capacity-building.
- It has been difficult to achieve joined-up working between the local authority and the NDC, with the latter being perceived as being 'out on a limb' and not relating well to the local governance and management structure. For their part, organisations working at the neighbourhood level complain about not seeing the bigger picture and how they fit into it.

The following Figures (called Policy Maps) summarise the complex web of linkages relevant to economic development in the area. Figure 2a illustrates the Enterprise and Business policy area; Figure 2b looks at Employment and Skills, and Figure 2c shows the main policy linkages in the field of Regeneration. Although these links and titles of organisations change over time, and in a few cases may have moved-on since the research was undertaken, they broadly remain current.

Figure 2a: Oldham Local Economic Development Policy Map

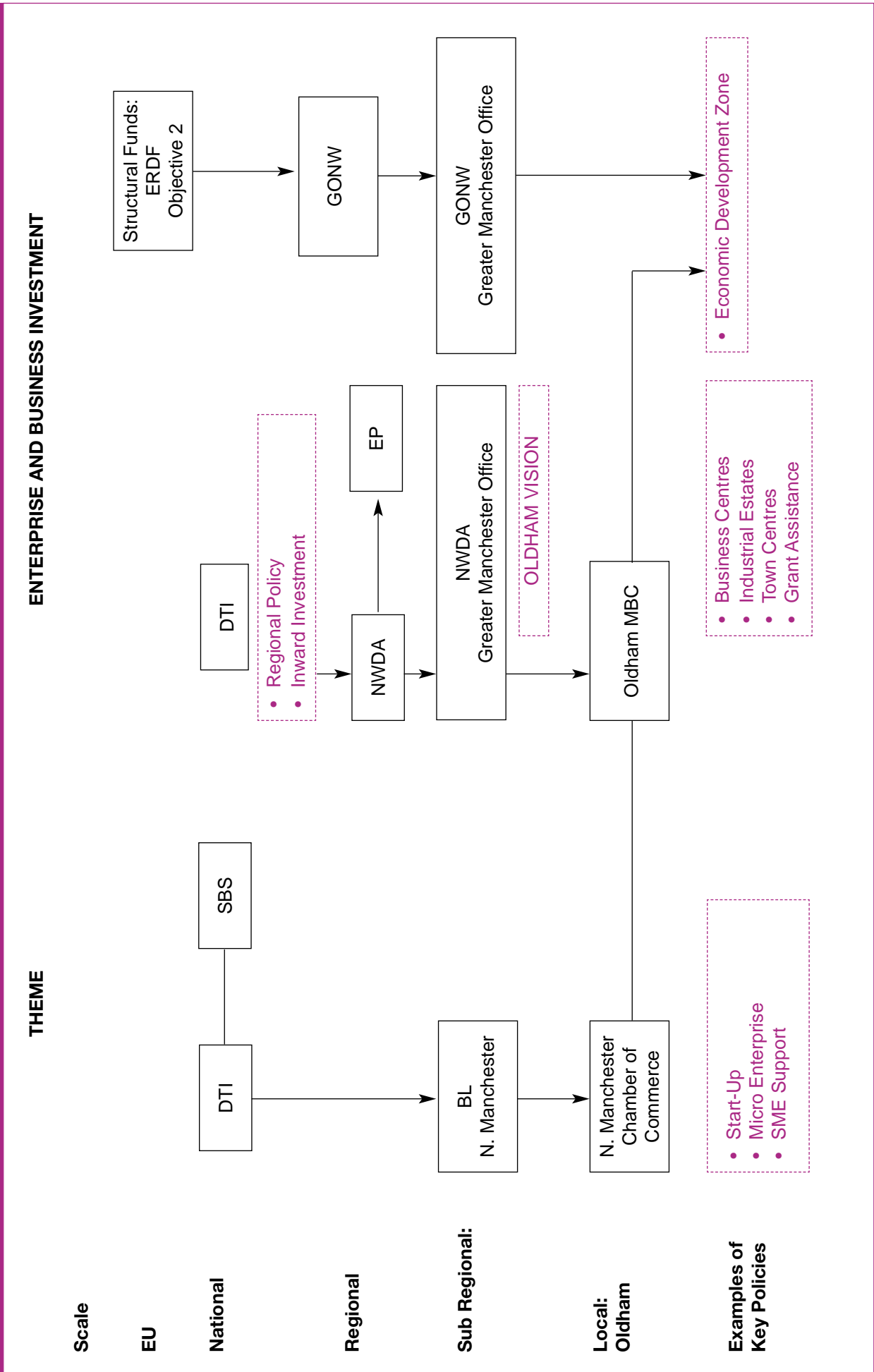

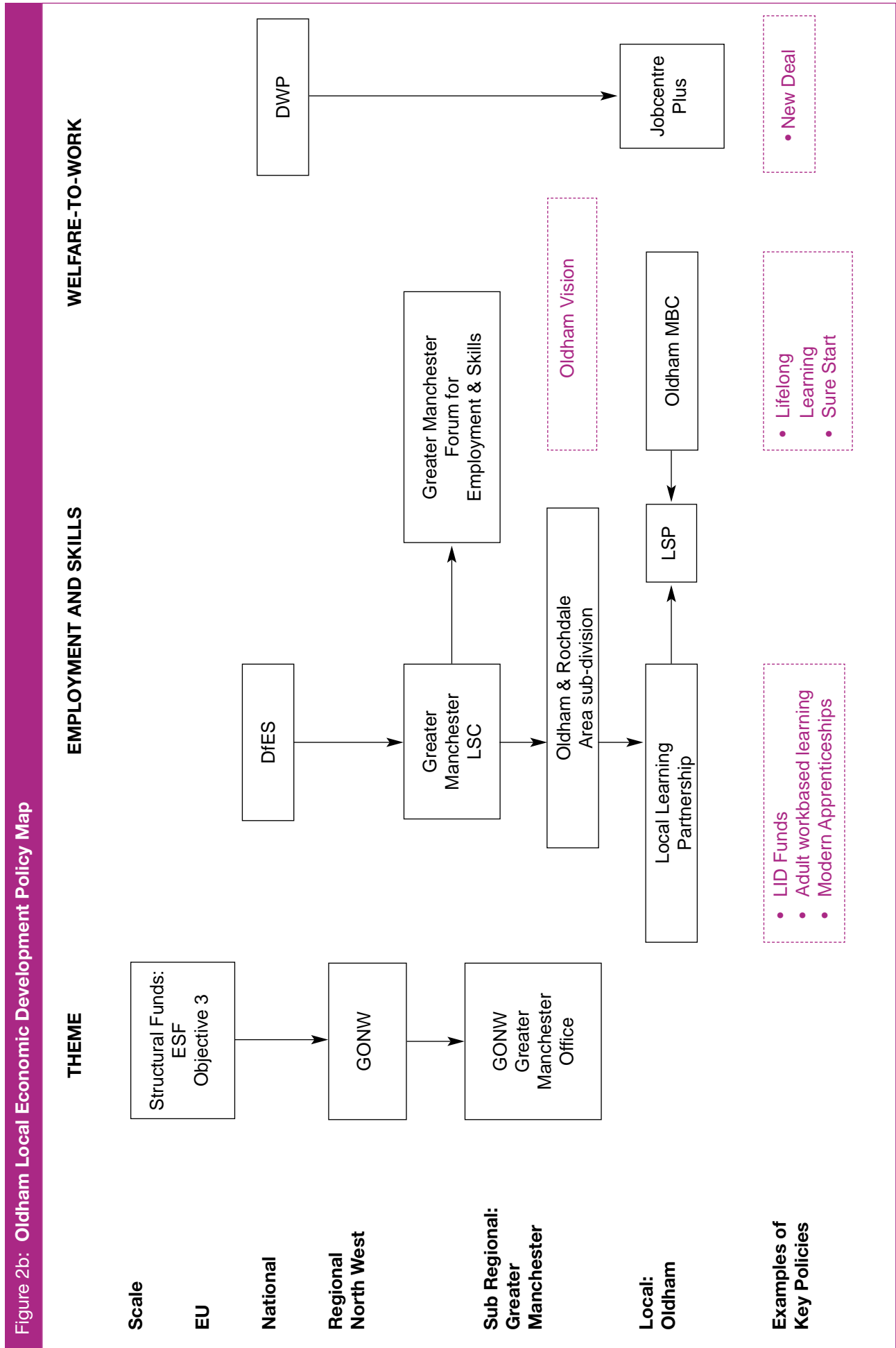
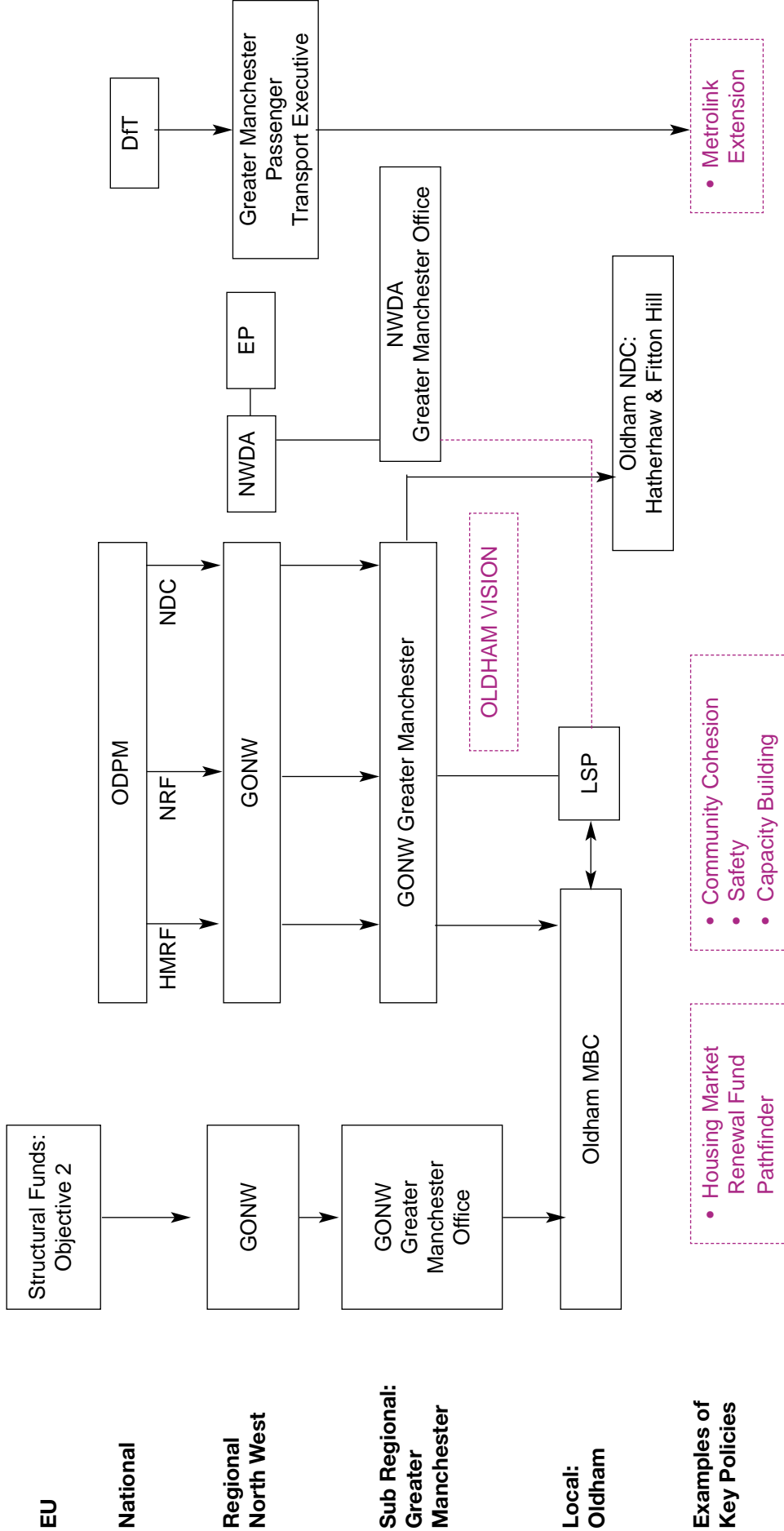

Figure 2c: Oldham Local Economic Development Policy Map

AREA AND COMMUNITY REGENERATION

THEME

Scale



## CASE STUDY 3

### Mansfield

#### 3.1 DYNAMICS OF THE LOCAL ECONOMY

- Mansfield is located in the former North Nottinghamshire coalfield area and is the major town serving this area to the north of Nottingham. Since the late 1970s, the local economy has witnessed the long-term decline of coal-mining and traditional manufacturing industries such as textiles and engineering.
- By 2004, only two pits were still in operation within the Mansfield 'travel-to-work area' (TTWA), employing less than 1,000 people, compared with 13 pits employing 16,500 in 1984. The decline of the textile industry has been similarly dramatic and remains ongoing, with a further 3,000 jobs lost in textile manufacturing within the North Nottinghamshire/North Derbyshire sub-region in 1999-2000.
- The local economy is dominated by three sectors in terms of employment: distribution/hotels and restaurants/retail (27.7 per cent), manufacturing (22.7 per cent) and the public sector (17.7 per cent). Despite ongoing decline, the manufacturing sector (22.7 per cent) still employs above the national average (15.7 per cent). Employment in the public sector (17.7 per cent) is below the regional and national average of 23.7 per cent.
- Recent employment growth has been concentrated within relatively low value added and low paid service sector activity. Between 1997 and 2002 employment increased by 70 per cent in the wholesale trade and by 44 per cent in the retail trade.
- From a peak of 13 per cent in 1993, unemployment has fallen significantly to 5.1 per cent by 2000 and 4.0 per cent by 2004, although unemployment levels still remain above regional and national averages. Ward level unemployment rates for 2001 varied from a high of 8.7 per cent to a low of 2.0 per cent.
- There is a significant proportion of long-term unemployed (29 per cent) and people who have never worked (9 per cent). Unemployment disproportionately affects the younger age group, with nearly half of the total unemployed being aged less than 30.
- The employment rate in Mansfield District was 67.9 per cent of the working age population in 2001, compared to an East Midland average of 75.7 per cent, showing a decline between 1998-2001 of 3.1 per cent, compared to no change within the East Midlands region.
- The issue of 'hidden unemployment' is particularly pertinent in former coalfield areas such as Mansfield, and has been estimated to increase the 'real' unemployment rate to 15.7 per cent. Incapacity Benefit is claimed by

around 8,000 in Mansfield, accounting for over 10 per cent of the working age population in deprived wards compared to a national average of just 4 per cent.

- The combination of high levels of worklessness and low wages means that average household incomes remain significantly below regional and national averages. In 2000, 7.3 per cent of the total population claimed income support.
- The Mansfield workforce is characterised by relatively low levels of skills and education. In 2001 38.2 per cent of the resident population had no qualifications (29.1 per cent nationally) and only 10.0 per cent were qualified to degree level or higher (19.8 per cent nationally). Vocational skill levels are also low. School educational achievement is low, particularly in the more deprived wards, resulting in a poor level of basic skills.
- Although Mansfield has a below average level of entrepreneurship (23.7 new VAT registrations per 10,000 population compared with 38.5 in England), there has been an above average rate of business formation (a 44.7 per cent increase 1998-2003 compared to 30.3 per cent in the East Midlands and 30.6 per cent nationally).
- The informal economy plays an important role in sustaining the livelihoods of a large number of low income households. According to the interviewees there exists a very highly developed network to supply informal goods and services (eg car maintenance, cigarettes, building work, etc.). This reinforces problems of low quality and low skills within the local economy.

### **3.2 ECONOMIC PROBLEMS OF DEPRIVED NEIGHBOURHOODS**

- Mansfield has seven wards within the 10 per cent most deprived wards in England. In addition there are other pockets of deprivation which are hidden statistically by their proximity to more affluent areas.
- All the deprived neighbourhoods exhibit similarities in terms of relatively high levels of unemployment and worklessness, low rates of economic activity and employment, and low levels of household income and skills and education. Populations are largely white, with no significant ethnic minority groupings.
- The economic problems of the deprived neighbourhoods have their roots in the rapid decline of the coal-mining industry, as well as a similar large employment decline in traditional manufacturing activity such as textiles.
- The subsequent evolution of these neighbourhoods has been driven principally by processes of residential sorting. Following job losses, the more employable elements of the population have moved away, whilst due to market mechanisms and public housing allocation policies, low cost and generally low quality housing stock has attracted low income individuals and households often reliant on state benefits.



- The past economic structure of the local economy continues to have a lasting legacy, not only economically, but also socially and culturally. There is a lack of a culture of enterprise and self-employment, a tradition of relatively low level formal educational attainment, a strong gender division of labour and tradition of patriarchal relations, and an expectation that employment is located close to the place of residence.
- For certain sections of the population there is a 'culture of worklessness', with no or limited experience of employment extending across generations, and an expectation of 'getting by' on various forms of benefits, supplemented by various forms of informal economic activities. For others, employment is associated with low paid, semi-skilled employment with limited opportunities for career progression.

### **3.3 CASE STUDIES OF DEPRIVED NEIGHBOURHOODS**

#### **Northfield and West Titchfield**

- According to interviewees with good local knowledge, the key characteristics of Northfield are that:
  - it is primarily residential, comprising an interwar estate and older colliery housing, with a run down physical appearance and a significant number of boarded up vacant properties
  - there are problems with crime, drug abuse and lack of provision for young people
  - unemployment rates are nearly twice the district average
  - there are low levels of economic activity, associated with a high level of claimants for state benefits including incapacity and disability benefits
  - there are very low levels of education and skills with many lacking basic skills
  - there are very few local businesses and sources of employment
- The key characteristics of West Titchfield are that:
  - the area is close to the town centre and comprises both a residential area of dense terrace housing, as well as an area of mixed residential and industrial use which suffers particular environmental problems
  - the population comprises residents of longstanding, and a more mobile incoming population resident in private sector rented property
  - the younger incoming population has resulted in a relatively youthful population with a high birth rate and a high rate of teenage pregnancies

- whilst the economic activity rate is relatively high, this is predominantly in low skill and low income jobs which reflect the wards location close to the town centre
- there are 538 employment units in the ward employing 8,699 people in 2002
- there are a number of basic barriers to employment within the area, including low aspirations, particularly amongst the young, and a common perception that low paid work offers little material advantage compared to continuing to claim state benefits

### **3.4 CO-ORDINATION AND INTEGRATION OF POLICY STRATEGIES AND ECONOMIC INITIATIVES**

- The key institutions involved in the strategic development and delivery of local economic development and neighbourhood renewal within Mansfield are Mansfield District Council and the Mansfield Area Strategic Partnership (MASP). These two bodies work closely together, and with a number of other key local institutions in the development of strategy and delivery.
- At the regional/sub-regional level the key agencies are EMDA (East Midlands Development Agency) and its decentralised Sub-Regional Partnership (Alliance SSP), the Government Office for the East Midlands and Nottinghamshire County Council.
- Mansfield's local economic development strategy produced by Mansfield DC reflects the close working relationship with MASP, and is clearly aligned to MASP's Community Strategy. The emphasis is strongly upon social inclusion as well as economic growth, which includes explicit recognition of the needs of the most deprived neighbourhoods.
- The overall business support and inward investment policy in Mansfield has seen a shift in focus, away from maximising job creation on key strategic brownfield sites close to areas of unemployment, towards an emphasis upon the creation of quality jobs in the knowledge based and service industries, and growing local businesses.
- As part of its Neighbourhood Renewal Strategy, MASP has pursued a strong community engagement strategy, with the result that it reflects the communities priorities upon 'crime and grime' and also education and health. Economic development and jobs have not been seen as a top priority.
- Programmes that encourage employers to recruit from deprived neighbourhoods have met with limited success, as often the target group lack the appropriate basic skills and commitment to employment.

- A notable feature of the economic development strategy for the Mansfield local economy is that it involves the active participation of a range of local actors, based on a mature and well-rooted area partnership that was originally formed in 1999 and has subsequently transmuted into the current local strategic partnership (MASP).
- A further important feature of current governance arrangements is the relative weakness and low profile of the sub-regional partnership dimension compared to other economic development institutions and levels of intervention. This is, in part, the result of the relative recent creation of Alliance SSP compared to other organisations. This has clearly limited the ability of Mansfield DC and MASP to link its actions into any clearly articulated sub-regional strategy.

The following Figures (called Policy Maps) summarise the complex web of linkages relevant to economic development in the area. Figure 3a illustrates the Enterprise and Business policy area; Figure 3b looks at Employment and Skills, and Figure 3c shows the main policy linkages in the field of Regeneration. Although these links and titles of organisations change over time, and in a few cases may have moved-on since the research was undertaken, they broadly remain current.

Figure 3a: Mansfield Local Economic Development Policy Map

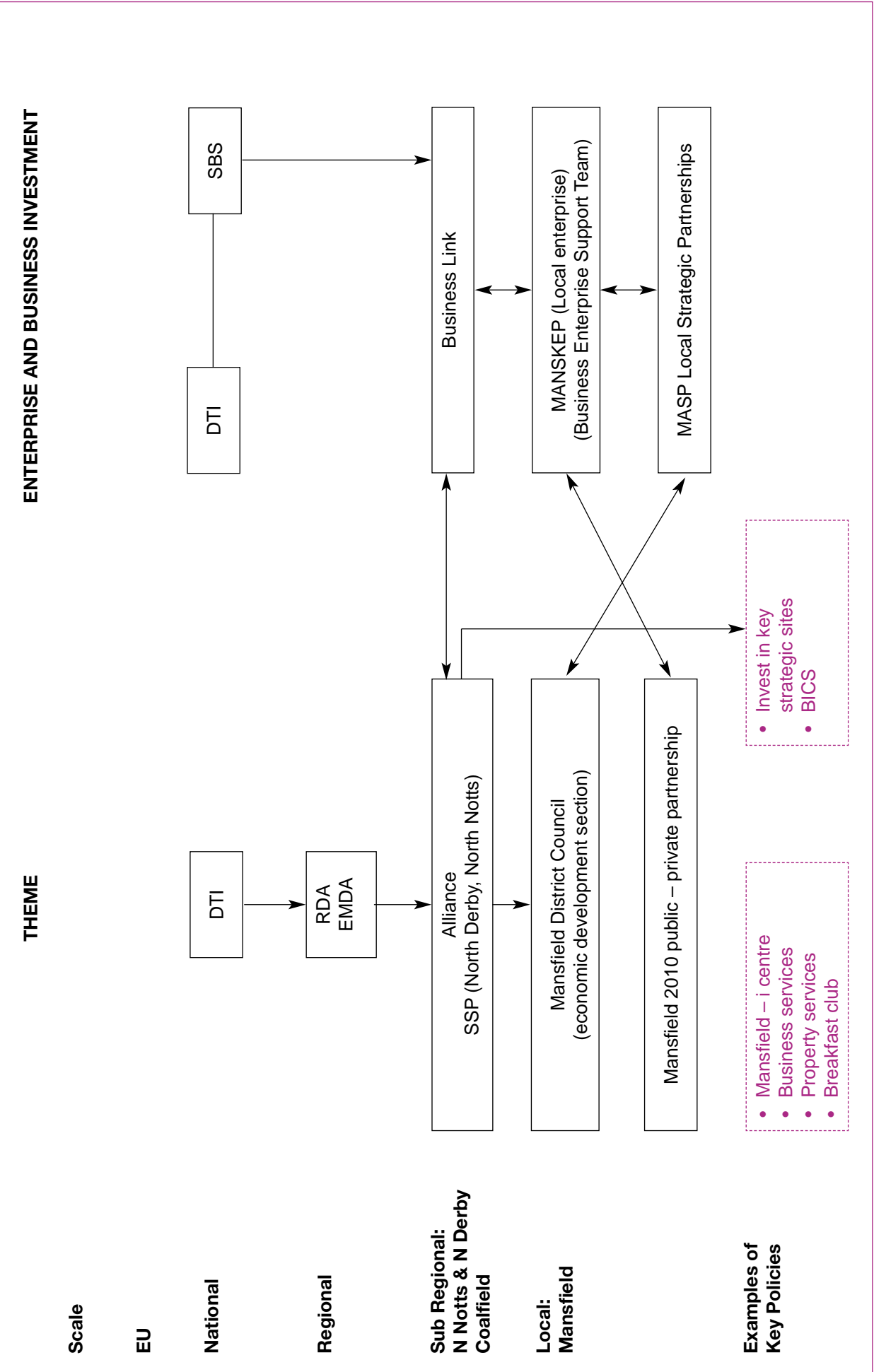

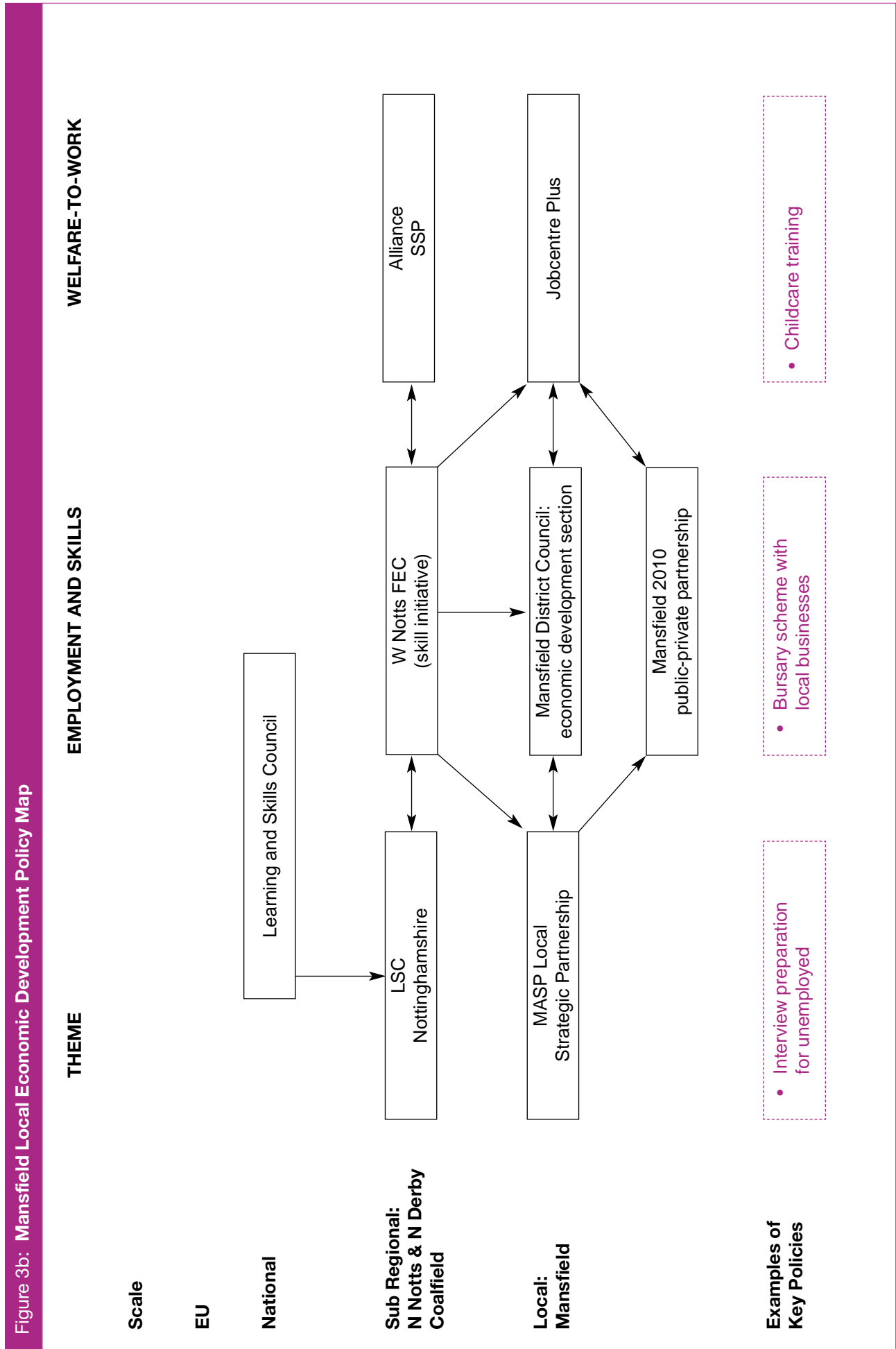

Figure 3c: Mansfield Local Economic Development Policy Map

**AREA AND COMMUNITY REGENERATION**

**THEME**

**Scale**

**EU**

Structural Funds:  
Objective 2  
ERDF & ESF

**National**

ODPM

**Regional  
North West**

GOEM

EMDA

**Sub Regional:  
N Notts & N Derby  
Coalfield**

SRB 5,6 Alliance SSP

Nottinghamshire  
County Council

**Local:  
Mansfield**

Mansfield District Council  
(Urban Regeneration Section)

Mansfield Area Strategic Partnership

**Examples of  
Key Policies**

- Neighbourhood Renewal Strategy
- Medan Valley Partnership
- Town Centre Partnership

- Neighbourhood Management Teams

- Community + Voluntary Sector Forum

## CASE STUDY 4

### Brighton and Hove

#### 4.1 DYNAMICS OF THE BRIGHTON ECONOMY

- Although Brighton and Hove has experienced considerable economic growth during the past five years, it remains a relatively low pay economy due to there being fewer high paid professional and managerial jobs than elsewhere in the South East region.
- Major concerns relate to the potential mobility of a number of larger employers whose headquarters are elsewhere, the growth of low skill/low paid jobs in call centres which are vulnerable to 'off-shoring' and the lack of brownfield development land and premises to facilitate existing business growth.
- The gross value added per capita is only 73 per cent of the regional average, due to a bias towards labour intensive sectors such as tourism, education and health.
- 90 per cent of employment is within service sectors, the public services accounting for around 27 per cent of local employment (including two large hospitals and universities). More than 2,000 additional jobs were created in the education and health sectors over the 1997-2002 period.
- The financial services and business services sectors account for 25 per cent of local employment and have created an additional 3,000 jobs over the 1997-2002 period. The vast majority of these are lower order clerical and administrative jobs.
- Although Brighton and Hove has been promoted as a key location for the creative industries, there are concerns about the sustainability of this sector in the absence of any large firms.
- A measure of the dynamism of the city's economy is the 22.3 per cent growth in the numbers of VAT registered businesses over the 1998-2003 period (compared with 9.2 per cent nationally) and an average VAT registration rate over this period of 48.5 registrations per 10,000 adult population compared to 40.7 nationally.
- Unemployment remains significantly above that of the South East region as whole (3.1 per cent compared to 1.5 per cent in July 2003). Just over a third are long-term unemployed.
- The population has been growing twice as fast as that nationally, much of the growth being in the younger age cohorts. The city is an especially popular residential location for young adults.

- The workforce is characterised by relatively high levels of skills and education, with a smaller proportion (22.1 per cent) without qualifications than nationally (29.1 per cent) and a higher proportion with at least degree level qualifications (28.7 per cent compared with 19.8 per cent nationally). However, more than a third of the working age population are without qualifications in parts of East Brighton.

## **4.2 ECONOMIC PROBLEMS OF DEPRIVED NEIGHBOURHOODS**

- Despite the city's rapid economic growth, there remain pockets of deprivation in East Brighton where low cost and public housing was built in the post Second World War period to house the workers of large manufacturing employers that have since closed. Two wards are ranked within the five per cent most deprived wards nationally and a third ward just outside the 10 per cent most deprived wards.
- East Brighton is a net exporter of low paid, low skilled activities and a net importer of professional occupations, notably to the Sussex County Hospital and University of Brighton. The working resident population is heavily dependent upon low paid employment in retailing and tourism.
- Evidence shows that many of those out of work do not know anyone in work, having grown up on estates where unemployment is commonplace and where there are no role models of friends and family in work.
- Teenage pregnancies leading to single parenthood is a major social issue in East Brighton, being a cause of benefit dependency and barrier to obtaining employment.
- There is a 'locked in culture' whereby many residents do not consider the possibility of working outside their locality, despite good public transport links to areas where there are employment opportunities.
- The transient nature of the population is making it difficult to break out of the cycle of decline, with those who find work moving away only to be replaced by those who are unemployed.
- Much of Brighton and Hove's small stock of social housing is concentrated in the East Brighton area, with almost two thirds of residents living in social rented properties. The Council wants to attract more 'mixed tenure' and a greater diversity of population to these neighbourhoods.

## **4.3 CASE STUDIES OF DEPRIVED NEIGHBOURHOODS**

### **Saunders Park and North Moulsecoomb**

- Saunders Park is an area of social housing operated by a consortium of housing associations, with good accessibility to the city centre. It is characterised by:



- a young, transient population
- a lot of young lone parents, yet no local family or older resident support network for childcare arrangements
- little wealth retention
- poor local financial service provision, with no banks or post offices
- a cycle of decline, as those with work tend to move away to be replaced by the unemployed and workless
- North Moulsecoomb is the most deprived ward and mainly consists of social housing. It is characterised by:
  - many long established families experiencing several generations of unemployment
  - very low educational attainment
  - those who are working are typically in part-time and seasonal low paid service work
  - some local employment opportunities in light industrial and service activities

#### **4.4 CO-ORDINATION AND INTEGRATION OF POLICY STRATEGIES AND ECONOMIC INITIATIVES**

- In recent years there has been a proliferation of local economic development partnerships and three separate city-wide regeneration strategies originating from different organisational interests and government programmes, resulting in some tension between the business development and social inclusion interests.
- At the sub-regional level (ie Brighton and Hove and the neighbouring district of Adur), the Area Investment Framework is now the principal vehicle for achieving closer integration and joint-working.
- Brighton and Hove Council's Economic Regeneration Division is a facilitator rather than deliverer of services, with its strategic priorities being presented in the Brighton and Hove Regeneration Strategy (April 2002). The SRB has been the main source of funding for the Council's regeneration policy initiatives since the mid 1990s.
- As most of the LSC Sussex's funding is ring fenced, it has relied on European Social Fund (ESF) financing for projects targeted at deprived neighbourhoods, such as those involving the community and voluntary sectors.

- The New Deal for Communities programme, East Brighton 4 You (EB4U), focuses on five neighbourhoods within East Brighton. Enterprise theme projects include employment outreach, assistance to existing small businesses and start-ups, several community enterprises, a credit union, and childcare to help lone parents obtain paid employment.
- There is some move towards more joint funding of local economic development projects, involving the South East England Development Agency (SEEDA), LSC Sussex, and Jobcentre Plus, although the voluntary and community sector is concerned that this will disadvantage it in bidding to run local regeneration projects.

The following Figures (called Policy Maps) summarise the complex web of linkages relevant to economic development in the area. Figure 4a illustrates the Enterprise and Business policy area; Figure 4b looks at Employment and Skills, and Figure 4c shows the main policy linkages in the field of Regeneration. Although these links and titles of organisations change over time, and in a few cases may have moved-on since the research was undertaken, they broadly remain current.

Figure 4a: Brighton & Hove Local Economic Development Policy Map

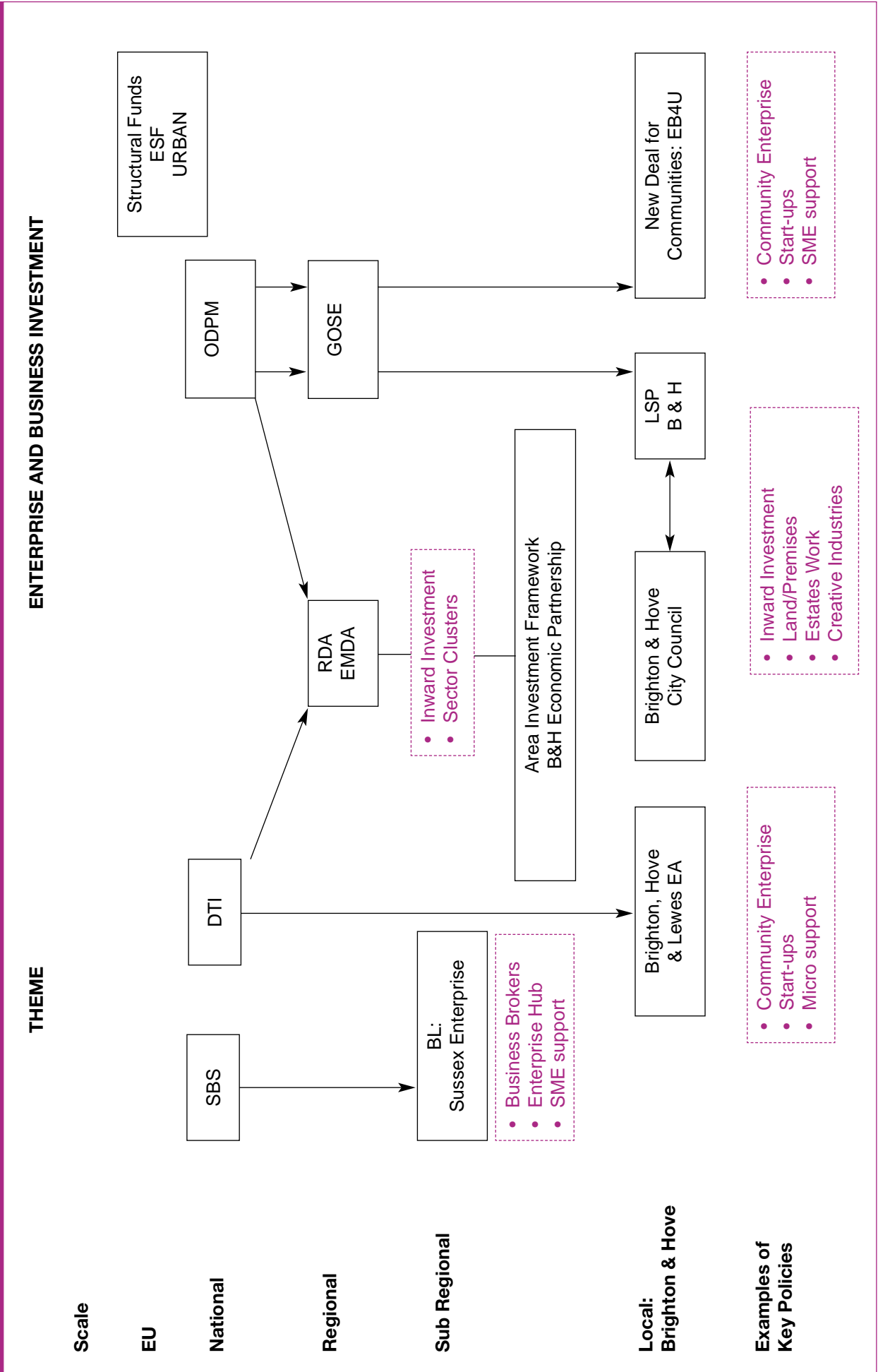

Figure 4b: Brighton & Hove Local Economic Development Policy Map

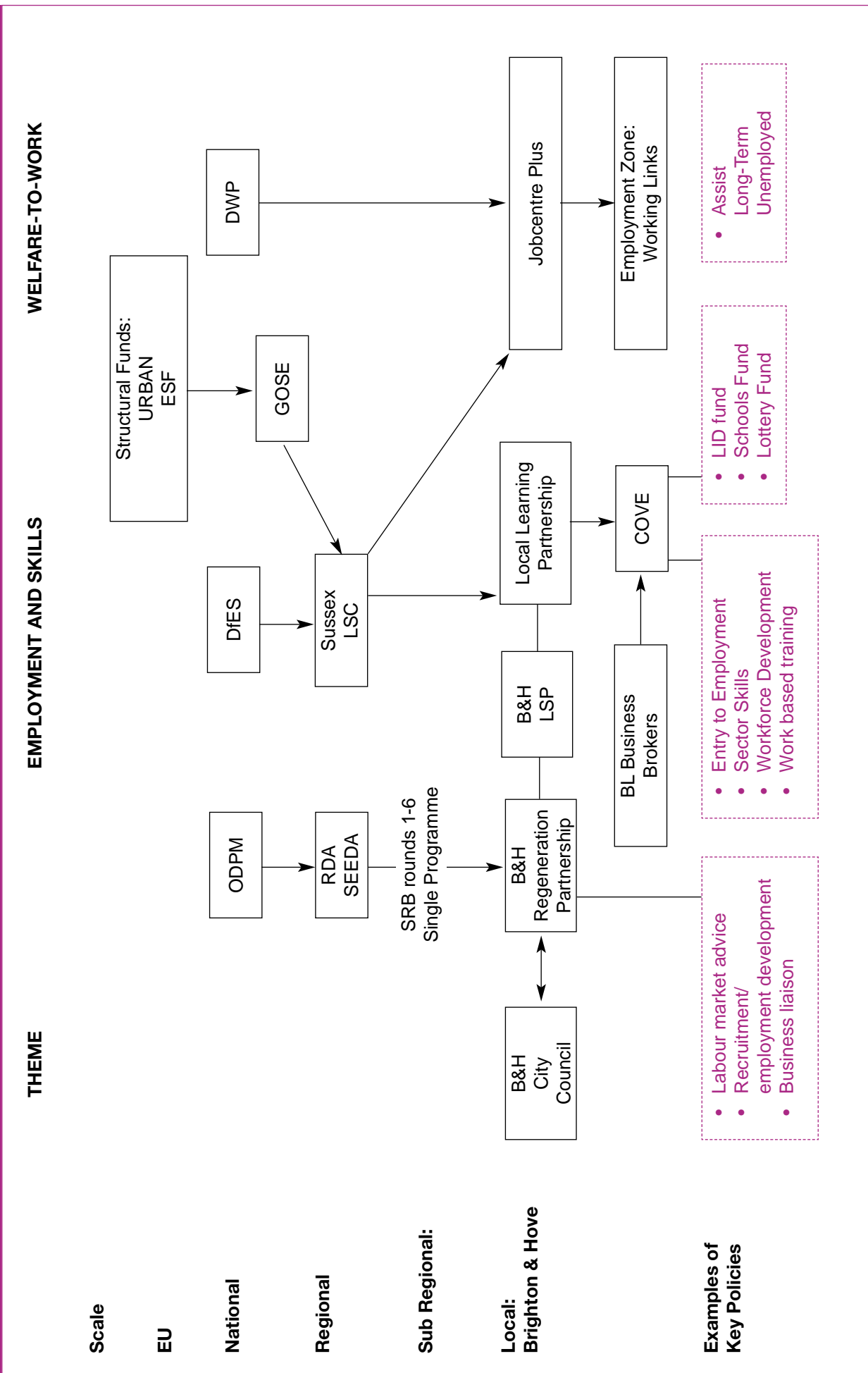
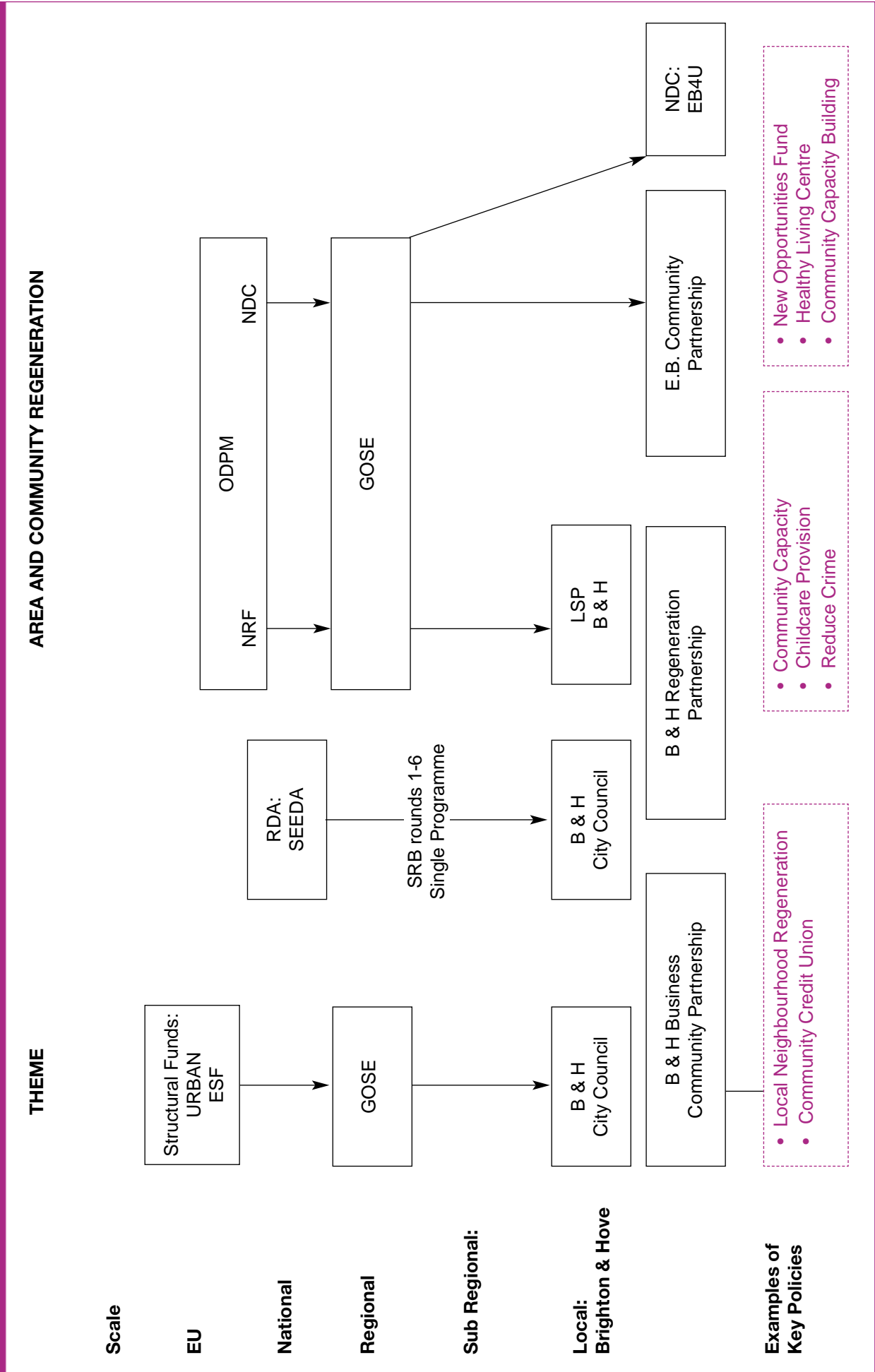

Figure 4c: Brighton & Hove Local Economic Development Policy Map



## CASE STUDY 5

### Newham

#### 5.1 DYNAMICS OF THE LOCAL ECONOMY

- The London Borough of Newham, in inner east London, was ranked as the fifth most deprived local authority district in England in 2000, despite being geographically close to the capital's financial centre.
- Newham has one of the fastest growing and youngest populations within England, increasing by 15 per cent between 1991-2001, compared with 4.4 per cent nationally. A consequence is that there is a larger proportion of dependants (less than 16 years old) than is the case in either London or nationally.
- Along with neighbouring Tower Hamlets, Newham has the most ethnically diverse population within England, with 61 per cent being drawn from non-white ethnic groups. Each of the main ethnic groups tends to be concentrated in different parts of the Borough.
- In 2001, a smaller proportion of Newham residents were employed in manufacturing (8.3 per cent) than was the case nationally (15.7 per cent), although this was slightly above the Greater London average (7.6 per cent). Employment within financial services (6.3 per cent) and business services (15.5 per cent) were above the national average (4.8 per cent and 13.2 per cent respectively), reflecting Newham's proximity to London's financial and business core.
- Similarly, the 'hotels and restaurants' and 'transport and communications' sectors account for significantly higher shares of the employment of Newham's population (7.3 per cent and 9.5 per cent respectively) than nationally (4.7 per cent and 7.1 per cent respectively). Public sector employment provides a large share of jobs for Newham residents (24.6 per cent).
- Newham's working population is skewed towards less skilled jobs, with fewer people in professional and managerial jobs, but higher proportions in personal service and sales jobs and in 'elementary' (low skilled) occupations.
- In terms of changes to the sectoral employment structure of Newham's local economy over the 1997-2002 period, although the number of jobs in manufacturing sectors declined (notably in metal products, clothing and printing), by far the largest reduction in jobs located in the Borough occurred in the finance and insurance sector (2,800 fewer jobs).
- The biggest increases in the numbers of jobs in Newham over the 1997-2002 period occurred in 'other business activities' (2,541 extra jobs), followed by

the retail trade (1,679) and construction (1,518). Large increases also occurred in education (1,437) and public administration (898).

- The business stock in Newham in relation to the resident population remains one of the lowest in London, with 35 VAT registered businesses per 10,000 people compared with 59 in London as a whole. The VAT registration rate over the 1997-98 to 2002-03 period averaged 24.8 per 10,000 adult population compared with a national average rate of 40.7, showing that Newham has a low level of new business formation, especially within a London context.
- The unemployment rate in Newham fell during 1991-2001 from 12.3 per cent (of the population aged 16-74) to 6.7 per cent. Over the last five years it has continued to fall and converged towards the London average. In July 2004, the Claimant Count unemployment rate in Newham was 4.5 per cent, compared with 3.3 per cent in London and 2.2 per cent in England.
- Newham is the highest ranked local authority in England in terms of the proportion of unemployed who have never worked (21 per cent). This is particularly high for women (26 per cent of unemployed women) and in those wards with large Asian populations (28 per cent).
- The level of economic inactivity has increased markedly over the last ten years, such that Newham has the highest inactivity rate in England. In 1991 the economic activity rate of the 16-74 year old population stood at 63.7 per cent (67.2 per cent for England), but this fell to 58.7 per cent in 2001 (compared to 66.9 per cent).
- The most commonly cited reason for being economically inactive in Newham is caring for the home and family, and the Borough has the highest proportion of inactive in the country identifying this reason, with particular concentrations in those wards with Asian populations.
- Just over one fifth of the economically inactive population living in Newham are students. Over the last ten years there has been a dramatic increase in the number of students living in the Borough, the availability of relatively cheap rented housing compared to other parts of London being a key factor.
- A large proportion of Newham's residents are disadvantaged in the labour market by their lack of, or low level of, educational qualifications, one third (33.6 per cent) having 'no qualifications' compared with 28.9 per cent nationally.
- Newham has attracted large numbers of foreign migrants and refugees in recent years and interviewees highlighted their lack of English language skills. Several argued that this and the low level of education qualifications generally lay at the heart of the employment problems experienced by Newham residents.

## 5.2 ECONOMIC PROBLEMS OF DEPRIVED NEIGHBOURHOODS

- Although the Borough as a whole was the fifth most deprived local authority in England in 2000, most of the wards rank between 200 and 500, showing a uniformity of deprivation throughout the Borough. The most deprived wards are Ordnance (ranked 35) and Beckton (ranked 79).
- The average gross weekly pay for Newham residents in 2002 was 23 per cent lower than that for all London residents. For all qualification levels, full-time employees living in Newham receive lower wages than similarly educated employees living in Greater London.
- The Income Support claimant rate is much higher than the national average (16.8 per cent of the 16-74 year old population in Newham, compared to 9.2 per cent in England), with some wards having rates of around 25 per cent.
- Interviewees with knowledge of the most deprived neighbourhoods suggested that a 'culture of worklessness' existed amongst certain groups, implying that low expectations and lack of ambition ensured that they were insufficiently motivated to find work. The benefits system was also seen by some as a barrier to employment in that there was a reluctance to substitute benefits for 'in work poverty' resulting from low paid and insecure employment.
- The housing market plays a key role in segregating poorer and more disadvantaged groups from more affluent groups. Newham has a higher proportion of households living in local authority and housing association housing than is the case in London as a whole, much of this being occupied by those who are economically inactive, particularly lone parents and retired people.
- The average number of lone parent households per 1,000 population in Newham is significantly higher than in Greater London, and the proportion of households in Newham that have lone parents with dependent children is the highest in England and Wales. Research evidence indicates that this contributes to the high levels of unemployment and economic inactivity found in the Borough, and that the availability and affordability of childcare is likely to be an important barrier to employment.

## 5.3 CASE STUDIES OF DEPRIVED NEIGHBOURHOODS

### **Becton and Green Street**

- The following two deprived neighbourhoods have been selected from different parts of the Borough: (i) Beckton in part of the former Royal Docks area which has undergone redevelopment since the 1980s, and (ii) Green Street, an area of poor housing in the north east of the Borough which has a high concentration of Asian people.



## **Becton**

Key characteristics are:

- although one of the most deprived wards within Newham, Becton is undergoing various changes related to the new developments in this former docklands ward
- unlike Newham as a whole, just over half of the population are white (51 per cent compared with 39 per cent)
- the employment rate is slightly above the Borough average (51.5 per cent compared with 47.7 per cent in Newham as a whole)
- the average income in 2000-01 was significantly above the Borough average, reflecting the fact that a higher proportion of the working population have professional or managerial jobs than found in the Newham as a whole
- key informant interviews drew attention to changes in the social composition as a result of much of the new housing attracting people from outside the Borough wanting to buy their own home
- the character of the local economy has been changing with the traditional dock related industries being replaced by various ‘lifestyle services’, including a developing hospitality cluster targeting corporate business clients
- a common criticism of the new housing estates is that they lack a sense of community and contain few community facilities including shops, with the result that much of the income ‘leaks out’ of the area

## **Green Street wards (East and West)**

- the area is characterised by a large Asian population (65 per cent), primarily families of Indian (30 per cent) and Pakistani (17 per cent) origin, but also a sizeable Bangladeshi (16 per cent) community
- the unemployment rate in 2001 in Green Street West (GSW) and Green Street East (GSE) was 7.3 per cent and 7.0 per cent, compared with 6.7 per cent for the Borough as a whole
- the employment rate is very low, 40.7 per cent in GSE and 42.0 per cent in GSW, compared with 47.7 per cent in Newham as a whole
- the most common reason for being economically inactive is looking after the home and family (28 per cent of the inactive) and reflects cultural traditions relating to the role of the women in Asian families as well as language barriers to obtaining work
- average incomes in 2000-01 were below those of Newham as a whole and the rate of increase in incomes since 1997-98 has been slower
- interviewees describe the area as a ‘close-knit’ Asian community with a vibrant but self-contained economy

- the economy of Green Street is dominated by small independent retailers and wholesalers, specialising in food, textiles and jewellery which mainly cater for an Asian (and predominantly local) market
- partly as a result of a number of initiatives to promote the area, Green Street is now attracting visitors and ‘cultural tourists’ from elsewhere in London and beyond

#### **5.4 CO-ORDINATION AND INTEGRATION OF POLICY STRATEGIES AND ECONOMIC INITIATIVES**

- At the London region scale, east London is being prioritised within the London Plan and the London Development Agency (LDA)’s revised economic development strategy for new development, regeneration and investment. In Newham, the challenge is to be able to seize the opportunities in areas such as Stratford and the Royal Docks to improve the employment prospects for those living in the many deprived wards within the borough.
- The main sub-regional organisation covering east London at present is the Thames Gateway London Partnership (TGLP), this being a voluntary sub-regional partnership. The TGLP produced an economic strategy, ‘Going East’, in 2001 to cover the 2000-06 EU Structural Funding period. A central objective of the strategy has been to redress the imbalance in London’s economy, by tackling barriers to economic opportunity and enabling a higher proportion of east London residents to access employment opportunities.
- As one of London’s most disadvantaged boroughs, Newham has had a strong commitment to economic and social regeneration over many years, has qualified for nearly all the government’s urban policy and regeneration initiatives, and has received over £300m of regeneration monies since 1996.
- Over the last 10 years the SRB has been an important source of funding for a range of regeneration initiatives in particular localities within the Borough, as well as several thematic, cross borough initiatives. The ESF has been helping to fund a number of skills and employment training projects as well as community economic development initiatives within the Borough over the 2000-04 period.
- Much of the Borough’s economic development activities are now encompassed by the ‘Your Newham’ Local Strategic Partnership, with ‘employment’ being one of six workstreams. Following a recent reorganisation of the LSP, the Borough is currently finalising several strategies, including a new Regeneration Strategy and a revised Employment Strategy.
- At the local neighbourhood level, one of the main area-based initiatives is the West Ham and Plaistow NDC programme which started in 2000 with a budget of £54m over 10 years. The economy theme of the NDC focuses on reducing unemployment and increasing the employability of the resident

population, with several projects being training related or concerned with job brokerage.

- Some of the people involved with the delivery of regeneration policies were worried about the confusing number of small scale and often overlapping policy initiatives and projects concerned with regeneration, with resources being spread too thinly to achieve critical mass.
- Difficulties were identified in the matching of different funding streams, which has become more difficult with the phasing out of the SRB and the shift towards other regeneration resources, notably the Neighbourhood Renewal Fund (NRF).
- Unlike in some of the other case studies, the relationships between the local authority and the NDC appears to work well, as do those between the NDC and several other key local partners. This may be because strong ties between Newham Council and the West Ham and Plaistow NDC were built-in from the beginning.

The following Figures (called Policy Maps) summarise the complex web of linkages relevant to economic development in the area. Figure 5a illustrates the Enterprise and Business policy area; Figure 5b looks at Employment and Skills, and Figure 5c shows the main policy linkages in the field of Regeneration. Although these links and titles of organisations change over time, and in a few cases may have moved-on since the research was undertaken, they broadly remain current.

Figure 5a: Newham Local Economic Development Policy Map

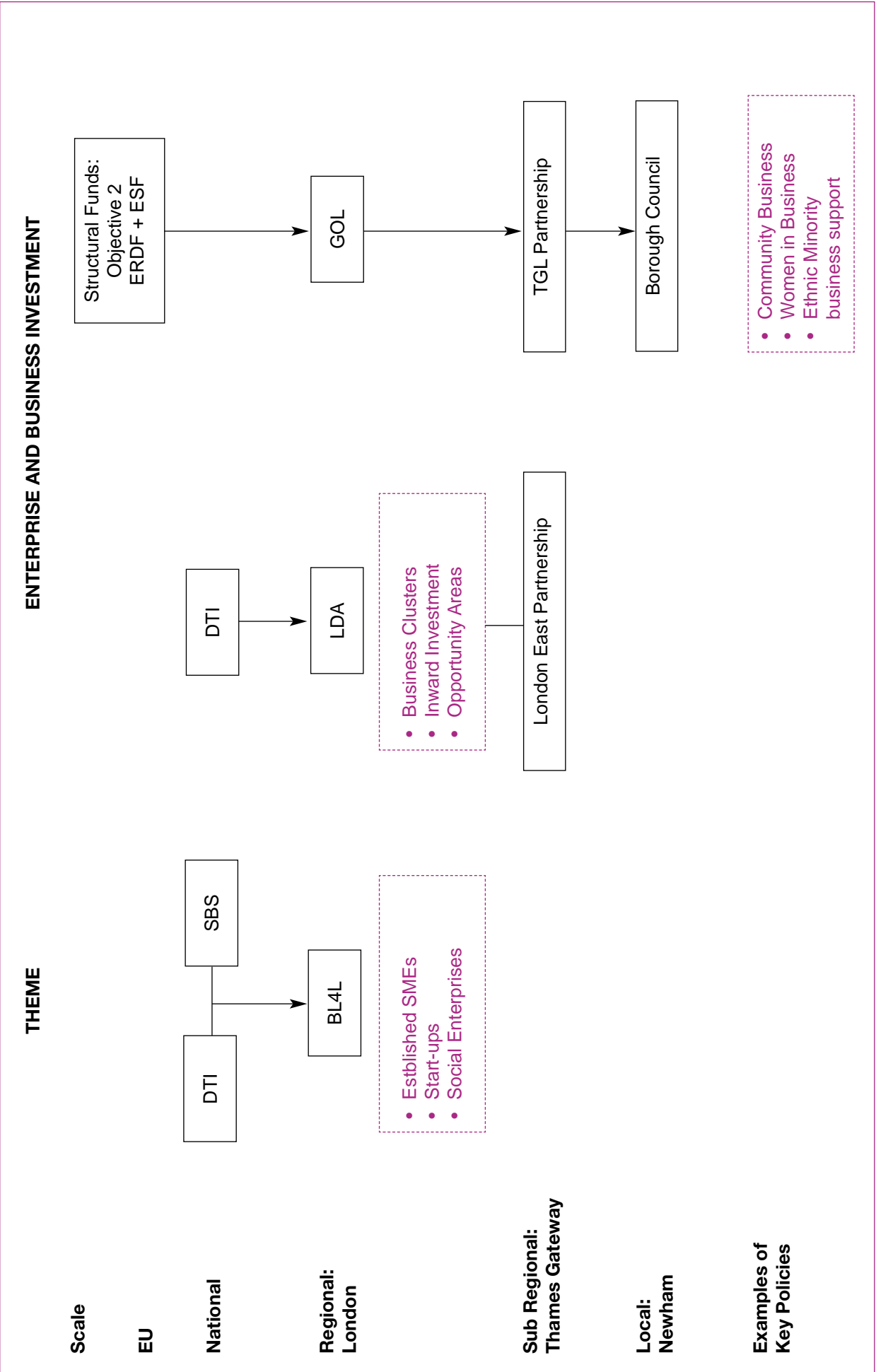

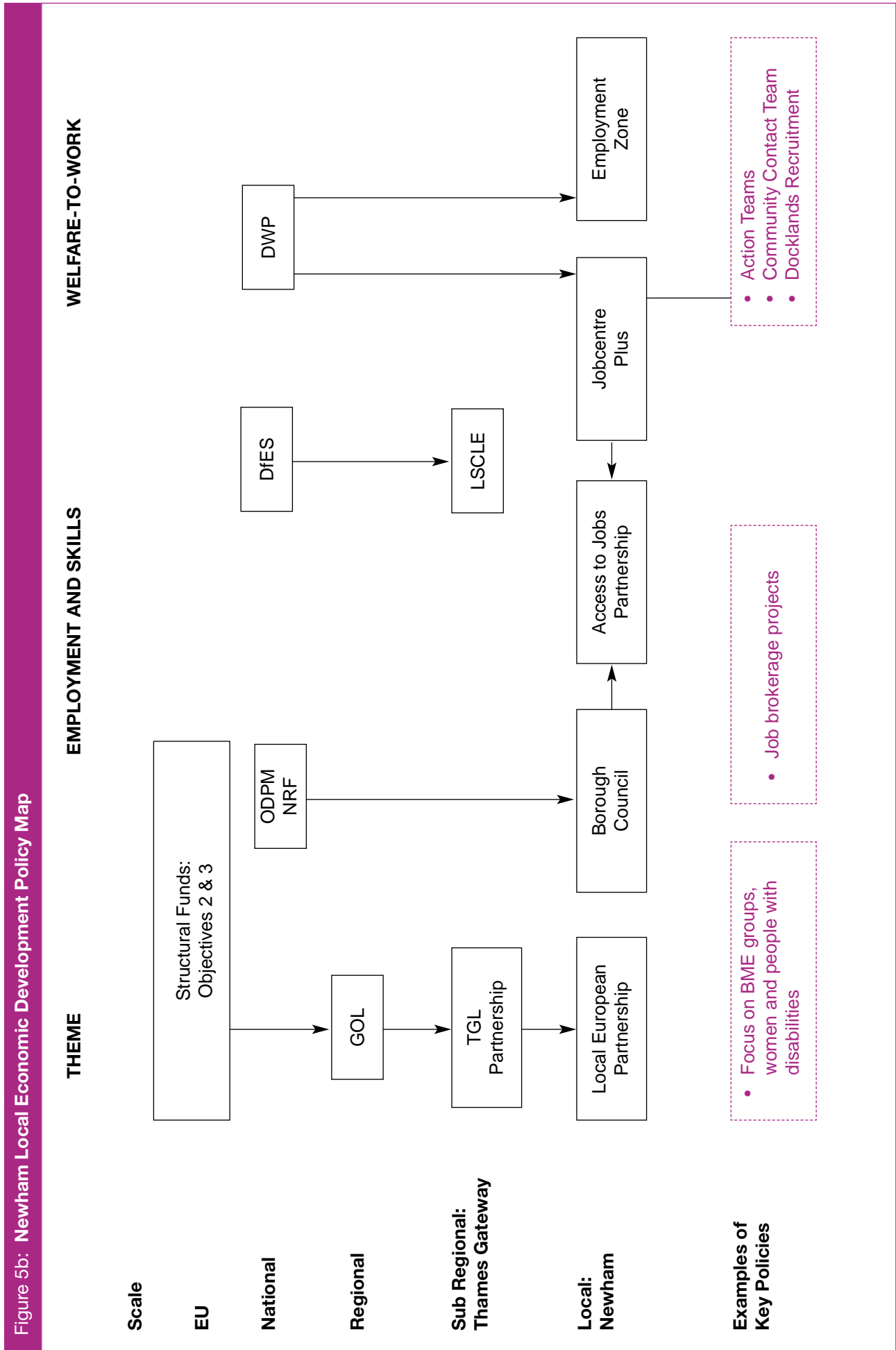

Figure 5c: Newham Local Economic Development Policy Map

**AREA AND COMMUNITY REGENERATION**

**THEME**

**Scale**

**EU**

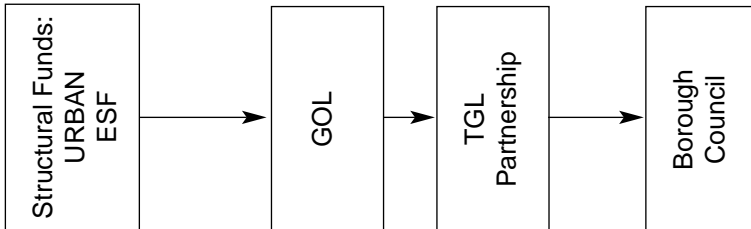

**National**

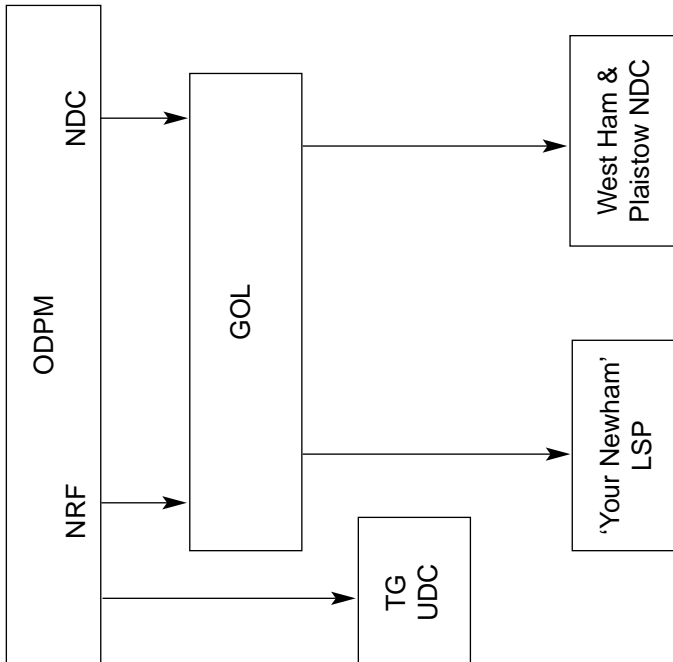

**Regional**

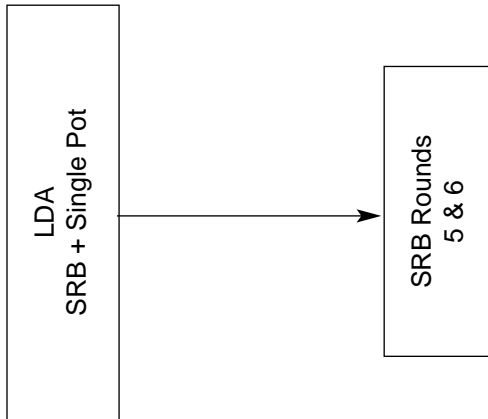

**Sub Regional: Thames Gateway**

**Local:**

**Examples of Key Policies**

- Empowerment of ethnic minorities
- Neighbourhood facilitation

- Job brokerage
- Resource Centres

- Stratford Tomorrow City
- Access to Excellence



Worklessness in Deprived  
Neighbourhoods: A Review of  
Evidence  
Summary





# CONTENTS

Introduction	83
Understanding the problem	83
Availability of jobs	83
Individual and household factors	84
Institutional factors	84
The need for a broad analytical framework	85
Impact of national policies	85
Impact of local action	85
Policy implications	86



## Introduction

This report provides a review of the available evidence relating to the problem of high levels of worklessness in deprived neighbourhoods, and the effectiveness of policy interventions to address the problem. The review was undertaken by the Policy Research Institute (PRI) at Leeds Metropolitan University on behalf of the Neighbourhood Renewal Unit.

## Understanding the problem

Changes in the nature, organisation and allocation of work have led to increased uncertainty, fluidity and insecurity in labour markets, which are characterised by a greater degree of segmentation and inequality, both socially and spatially. High levels of unemployment and inactivity have become entrenched amongst certain groups and in certain areas, and there has been increasing focus on the mismatch between high levels of worklessness in deprived neighbourhoods (DNs) and employment growth in areas peripheral to major urban centres.

There is a significant degree of variation between deprived neighbourhoods in terms of the incidence of unemployment and inactivity, poor qualifications and skills, ill-health and disability, the composition of groups vulnerable to worklessness (especially ethnic minorities), and characteristics of the local institutional context and wider labour market context. However, there is a lack of consensus in the literature about the explanation of the problem due to the lack of robust, definitive evidence and to the existence of competing theoretical frameworks which condition empirical research.

## Availability of jobs

Considerable research has been undertaken on the problems of 'spatial mismatch' and 'jobs gaps', but the evidence is inconclusive. There is some evidence to suggest that the focus on spatial mismatches mis-specifies the problem. There is little evidence to support the case for targeting job creation specifically at DNAs, firstly because of difficulties attracting businesses to deprived areas and, secondly, because of the problem of 'leakage' effects due to migration and commuting.

However, there is evidence to support the argument that greater attention needs to be given to demand-side factors. In some areas lack of demand constrains the effectiveness of efforts to secure work for more disadvantaged jobseekers. Moreover, the nature of available vacancies, wages, and terms and conditions locally are significant factors explaining the existence of recruitment difficulties; in particular, low paid, temporary, unskilled service sector jobs can be perceived as unattractive by male jobseekers.

There is also evidence that employers' recruitment practices have an important effect in reducing the chances of certain groups obtaining work. The extensive use of informal recruitment methods would appear to place jobseekers in DNAs at a disadvantage, and there is evidence of employer reluctance to recruit the

long-term unemployed, certain ethnic minorities, those with personal problems (eg language and mental health) and criminal records, residents of neighbourhoods with poor reputations and those dependent on unreliable public transport services.

## Individual and household factors

The weight of available evidence suggests that the extent and variability of the problem of unemployment and worklessness in DNs can be explained mainly in terms of ‘compositional effects’ – the characteristics and circumstances of individuals and households who tend to be concentrated in these areas. Given the variability between areas in terms of population composition this indicates the importance of careful analysis of the nature of the problem in any one DN as a basis for effective intervention. Key factors are household structure (especially lone parenthood), level of qualifications and skills, health and impairment, and age and ethnicity (with considerable variation between different ethnic groups). There is growing evidence that lack of access to personal transport can be a barrier to employment, especially for low income young people and women. The relative strength of these factors and the way in which they interact in different contexts (especially within DNs) is not well understood.

## Institutional factors

A number of factors in the local institutional context have an important influence on the scale and nature of the worklessness problem in DNs, and on the effectiveness of policy intervention. The housing market plays a key role in creating and maintaining spatial patterns of disadvantage, in particular segregating more disadvantaged groups in deprived neighbourhoods. Processes of segregation operate in both private and social housing, and there is some evidence that such processes operate to constrain opportunities for reduction of worklessness in DNs. There is evidence that the benefits system operates as a constraint on the willingness of some of the unemployed and inactive to take-up work perceived as low paid and insecure.

There is strong evidence that lack of available and affordable childcare is a significant barrier to employment for lower income parents with young children in DNs, particularly mothers and especially lone parents. There is also some evidence of significant barriers to the establishment of childminding businesses in DNs. There is growing evidence of how inadequate public transport services in many DNs act as a barrier to reducing worklessness, especially for young people and women with low incomes who tend to be more reliant on public transport. There is some evidence of the importance of the composition and structure of social networks in providing ‘bridging social capital’, but also the influence of ‘bonding social capital’, for example through ‘peer influences’ on attitudes and perceptions. There is mixed evidence on the existence and nature of ‘neighbourhood effects’ and they may largely represent unmeasured individual factors and effects of other factors such as social networks and employers’ ‘postcode discrimination’.

## The need for a broad analytical framework

Overall, the evidence reviewed provides some support for an analytical framework that combines factors relating to local labour market conditions that structure labour demand, individual and household characteristics and ‘family dynamics’, and characteristics of the local institutional context. There is some evidence to support the argument that a range of social and institutional factors (eg residential segregation and social capital) can combine and interact in DNs, so as to reinforce labour market processes that reproduce concentrations of worklessness, possibly in ‘vicious cycles’. Further research is needed to investigate this and the implications for policy.

## Impact of national policies

There is little evidence available from evaluations of national labour market policies and programmes of their impact on DNs, although there is quite good evidence about their effect on disadvantaged or ‘hard-to-help’ groups. However, this evidence does not always provide a robust picture of levels of deadweight and additionality. It is acknowledged that national programmes have had less impact on disadvantaged groups and areas than on the overall level of unemployment and worklessness.

Evidence from a range of sources indicates that national training programmes have not been very effective in meeting the needs and improving the employment prospects of groups who face the greatest disadvantages in the labour market. Evaluations provided good evidence of the effectiveness of training linked to employer placements and work experience. There is strong evidence that the New Deals have been relatively less successful for more disadvantaged client groups; in all cases, achievement of job outcomes has been lower for those with poorer educational qualifications and skills, for those unemployed longer and with less work experience, for those with poor health and disabilities and personal problems such as alcohol or drug dependency, homelessness, or a criminal record, and for ethnic minority groups.

Evaluations of Employment Zones and Action Teams for Jobs provide broadly positive assessments of their effectiveness in overall terms but, once again, there is evidence that these programmes have been less effective in helping the most disadvantaged groups. This is a significant finding in view of the fact that these initiatives are specifically targeted to address problems of high and persistent levels of worklessness amongst particular groups and areas.

## Impact of local action

Evidence on the effectiveness of local action is less robust, but indicates concerns about additionality and impact due to deadweight, substitution and leakage effects. There is good evidence from the evaluations of the City Challenge and Single Regeneration Budget (SRB) programmes that the effectiveness of employment and training initiatives is significantly influenced by demand conditions in the wider labour market, and of the importance of

connecting people to job opportunities there, of barriers due to lack of access to childcare and transport, and of the influence of the benefits system in conditioning people's perceptions and attitudes towards low wage/skill jobs. The evaluation of ESF Objective 3 found that local projects were less successful in achieving job outcomes for more disadvantaged groups, but provided evidence of the effectiveness of 'holistic' approaches to supply integrated packages of support for such groups.

Research on local job brokerage schemes, on local adult learning initiatives and on projects for young people with multiple disadvantages has provided additional supporting evidence on the need for 'holistic', client-centred approaches for disadvantaged groups underpinned by effective outreach and inter-agency collaboration. For job brokerage schemes, effective joint working with Jobcentre Plus is especially important. There is also increasing evidence that Intermediate Labour Markets (ILMs) can provide an effective model for the long-term unemployed by providing support and training in a real work environment. It is not clear to what extent local initiatives are succeeding in achieving sustained adaptation and improvement in 'mainstream' provision relating to the needs of DNs regarding employment and training, education, childcare, public transport, social housing and other supporting social, health and welfare services for those with multiple disadvantages.

## Policy implications

Existing labour market policies and programmes, while broadly successful in overall terms in reducing worklessness, have been less effective in helping the most disadvantaged groups and in reducing worklessness in deprived neighbourhoods. There is a need to improve the targeting of effective help on these groups and areas.

It is possible to conclude that traditional supply-side explanations of the problem do not provide an adequate basis for effective policy responses. A broader analytical framework is required that incorporates the influence of both labour demand conditions in the local labour market and key attributes of the local institutional context. Although it is difficult to make definitive generalisations about the relative importance of these analytical elements in explaining the problems faced by DNs, the following conclusions can be drawn:

- There is strong evidence to suggest that a large part of the explanation is contributed by *individual and household characteristics* and differences in population mix. This would justify a continued strong policy emphasis on measures to address key person- and household-related factors that have been shown to be strongly associated with worklessness, especially qualifications and skills (basic, vocational and social), lack of work experience, lone parenthood and such problems as alcohol and drug dependency and poor physical or mental health.
- There is also evidence of varying robustness to suggest that greater emphasis needs to be placed on addressing problems and barriers relating to aspects of the *local institutional context*. These include the local effectiveness of 'mainstream' welfare-to-work provision, the influence of the

benefits system, problems associated with attitudes and motivations towards work that might derive from ‘peer influences’ in social networks or involvement in the informal economy, the availability of childcare and transport, and the availability of health and welfare services. Moreover, more attention needs to be given to the way in which the social housing system influences the worklessness problem in DNs, especially through allocation policies.

- The available evidence supports arguments for greater attention to the role of *labour demand*, and the influence of the local labour market context on the worklessness problems faced by DNs and on the effectiveness of policy interventions. Stronger efforts are needed to obtain information about job opportunities available in the local labour market, and to influence employers to make vacancies available through formal channels rather than relying on informal approaches. A clear implication of the evidence is the need to work closely with employers at the local level to seek to influence recruitment practices, so as to improve the chances of securing jobs for the long-term unemployed, those with no work experience, ethnic minorities, those with disabilities and those with problems such as criminal records.

There is little evidential support, however, for a general policy of seeking to create new jobs in or close to DNs. The evidence actually suggests that the issue of generating new employment opportunities is addressed most effectively at the sub-regional level in the context of broader economic development strategies. It is important that such strategies give appropriate priority to the circumstances and needs of deprived areas in terms of the type of new jobs, opportunities to develop targeted recruitment initiatives with employers, and accessibility issues, relating both to the location of employment sites and to the availability of public transport.

Indeed, there are a number of aspects of the policy mix required to address worklessness in DNs that need to be developed further at the strategic level:

- As indicated above, policy efforts to influence *labour demand* need to be addressed in the context of local economic development strategies, linked to Regional Economic Strategies and Frameworks for Regional Employment and Skills Action (FRESA)s, assessing the potential for creating jobs across the local labour market and developing the initiatives required to maximise the potential for residents of DNs to secure these jobs, including targeted recruitment initiatives, more general work with employers to influence recruitment practices and public transport provision.
- As a further component of local strategies, there is a need to address key elements of the *local institutional context* that require action at the strategic level. Thus, it is important that strategic action on childcare provision and public transport through local authority strategies and plans fully addresses the needs of residents of DNs in terms of reducing barriers to training and employment. Policies in relation to social housing also need to take into account their long-term impact on worklessness in DNs.
- In view of the strength of evidence on the importance of school performance and educational attainment on subsequent employment



prospects, it is crucially important that local strategies for *raising educational attainment* are effective in addressing the problems of DNs, recognising the influence of parental attitudes and support, family circumstances and peer influences. Effective action in this area is likely to be crucial to the long-term regeneration of DNs, but needs to be part of an integrated strategic approach. Related to action on education is social welfare support for families, in order to minimise the effect on children of family dis-function (which can also include homelessness). Reduction of teenage pregnancy must be a key priority for education and social welfare services in view of the poor labour market prospects of lone parents.

The implication is that there needs to be a broad strategic approach that is capable of integrating all the relevant areas of economic and social policy required to achieve long-term, sustainable solutions to the worklessness problems of DNs. In view of the evidence which suggests that the interaction of various economic and social processes may reinforce persistent worklessness (and even create 'vicious cycles'), it is particularly important that policy action is co-ordinated and sustained over a sufficiently long period. Moreover, given the variations in population mix and certain aspects of the institutional context between different DNs, it is also important that strategic action is tailored to the circumstances of each area through appropriate targeting.

The policy framework for such strategic action has largely been put in place through two key Government initiatives – the National Strategy for Neighbourhood Renewal (NSNR) and the Local Government Modernisation Agenda (LGMA). This framework provides the basis for local authorities, working in partnership with Jobcentre Plus, and other local agencies and stakeholders, to play a leading role in addressing worklessness in DNs in the context of broader community strategies for the local authority district, which can address economic development, job creation, public transport provision, housing and educational attainment.

The success of local strategies to raise employment rates will be heavily dependent upon partnership working with Jobcentre Plus. The ability to adapt and tailor mainstream programmes to address the problems of the most disadvantaged groups and neighbourhoods depends on achieving local flexibility and developing innovative approaches locally. Recent measures to encourage discretionary local action by Jobcentre Plus and provide greater flexibility in the New Deals will help, but it is likely that more radical approaches will be needed.

The findings of this review provide support for the Local Government Association's (LGA) initiative 'Helping the hardest to Reach into Work', which has developed a 'Partnership Accord' with Jobcentre Plus to encourage local collaboration and joint working. This approach should be focused on deprived neighbourhoods in the context of Local Neighbourhood Renewal Strategies (LNRs), with community-based 'intermediary' organisations developing effective joint working with mainstream providers, especially Jobcentre Plus, in ways that enable the engagement and trust of local people to be sustained. Such outreach, intermediary approaches are likely to be characterised by substantial involvement of local community and voluntary sector organisations, but the sustainability and credibility of the approach locally will require the foundation

of provision to be supported by the local authority, with the approach tailored to local circumstances.

As regards the nature of intervention and support in neighbourhood-based initiatives, a number of key elements can be highlighted on the basis of this review:

- Effective outreach provision is essential in order to reach the most disadvantaged groups and minimise deadweight.
- More attention is needed on the scope for achieving flexibilities in national policies and regulations to adapt to local circumstances.
- Personal and social problems need to be addressed effectively, with adequate resources and time and good links with all relevant provider agencies.
- Approaches to building employability need to be work-focused with strong employer involvement and exploiting the potential of ILMs.
- There is a need for continuing support for people once they have obtained work, particularly those who may be more vulnerable to losing their jobs.
- Good relationships with employers are crucial in relation to vacancies, training, sectoral recruitment, post-employment support and the potential to influence recruitment practices.
- Effective partnership working with all relevant agencies at the local level is essential, especially Jobcentre Plus.
- The problems of DNs require long-term 'holistic' strategies to achieve sustained improvement; action to raise educational attainment is central to such strategies.



# Informal Economic Activities and Deprived Neighbourhoods

## Summary



# CONTENTS

Key questions	95
Defining characteristics of informal economic activities	95
Extent of current research into informal economic activities and deprived neighbourhoods	96
The role of informal economic activities within the economy and labour markets of deprived neighbourhoods	97
Informal economic activities as both a negative and positive force for economic activity within deprived neighbourhoods	98
Impacts of current policies and regulations upon the operation of informal economic activity in deprived neighbourhoods	99
Challenges and opportunities for further policy development	100



## Key questions

In attempting to address the economic problems of deprived neighbourhoods, there is growing appreciation among researchers and policy-makers of the fundamental importance of informal economic activities, and an awareness that these activities have been neglected within research and policy development. Following consultations with policy advisers and research managers in various government departments, the Neighbourhood Renewal Unit (NRU) commissioned this report. Its aim is to review the existing evidence base relating to informal economic activities within deprived neighbourhoods, and provide insights to shape future policy development. The report addresses four key questions:

- What are the defining characteristics of informal economic activities? What is the most appropriate and practicable notion of such activities with regard to deprived neighbourhoods in the UK?
- What role do informal economic activities play within the economy and labour markets of deprived neighbourhoods? What are the patterns of movement into, within, and out of the informal economy?
- To what extent are informal economic activities both a drain *and* a positive force for economic activity within deprived neighbourhoods?
- What are the impacts of policies upon the operation of informal economic activity in deprived neighbourhoods? What are the challenges and opportunities for further policy development?

## Defining characteristics of informal economic activities

This review adopted a definition of informal economic activities that identifies three major types: *informal paid work*, *illegal economic activity*, and *informal unpaid work* (comprising *self-provisioning* and *mutual aid*). This definition recognises the wide spectrum of informal economic activities and that these activities are not just unregulated or unseen, but also largely unremunerated.

Although informal economic activities cannot be considered in isolation from each other, there are clear advantages in identifying these sub types in order both to capture the *breadth and complexity* of informal economic activities and to provide an *appropriate framework for analysis and policy development*. For deprived neighbourhoods, such a definition indicates the need for greater clarity in research for understanding the dynamics of these activities and how they are rooted within specific deprived neighbourhoods, as well as identifying a range of options for policy development.

The definition avoids the tendency of much current research and policy development work to adopt a narrow focus on only the monetised or 'cash-in-hand' element of informal activity. Narrow definitions of this sort lose sight of



the potential of the sector, as they fail to acknowledge the *importance of mutuality and reciprocity found in non-market based exchange*. Such elements are particularly important within deprived neighbourhoods given the restricted ability of many of those living in such areas to participate within commodified, market exchange relations.

Central to understanding and defining informal economic activities is their *intense relationship with 'formal' economic activities*. It is for this reason that the report avoids the use of 'informal sector' and 'informal economy', as such terms infer a degree of separateness from formal economic activity which does not exist in practice.

## Extent of current research into informal economic activities and deprived neighbourhoods

The review demonstrates (up to Dec 2004) the limited amount of contemporary research literature of all types currently available on informal economic activities within the advanced industrial economies in general, and deprived neighbourhoods in particular. Where research and policy work does exist, it has a tendency to focus on the 'cash-in-hand' element of informal work.

There are numerous gaps in knowledge and understanding of all aspects of informal economic activities. Some of the most important include:

- details of engagement in informal economic activities with respect to different ethnic groups, age/life-cycle, and gender roles
- the relationship between deprived neighbourhoods and the wider local/regional economy in terms of the market for informal goods and services
- public attitudes towards informal economic activities
- the process and extent to which informal economic activity develops entrepreneurial skills and leads to small business start-ups
- systematic and critical evaluations of the socio-economic impacts of initiatives which have sought to promote informal economic activity
- the identification of means for assembling greater knowledge on the nature and extent of informal economic activities in specific localities to inform local level policy development

## The role of informal economic activities within the economy and labour markets of deprived neighbourhoods

Informal economic activities play a complex and diverse role within deprived neighbourhoods. The nature and type of informal work is *rooted within the specificities of particular neighbourhoods* and is particularly influenced by the extent and nature of *formal economic activity*, the characteristics of the *local labour market*, the characteristics of the *local population*, and the insertion of the neighbourhood within the *wider local/regional economy*. In consequence, the precise nature and scale of informal economic activities is likely to vary significantly between deprived neighbourhoods.

As a result of this complexity and the lack of empirical research it is *difficult to provide accurate data* as to the scale and nature of informal economic activity within deprived neighbourhoods. Estimates of the size of the informal economy are hampered by the lack of agreement about definitions and methods that depend upon a high level of untenable assumptions. Different forms of informal economic activity require the use of different indicators.

Despite the limitations of the available data, it is apparent that informal economic activity in general remains an important and growing element of contemporary society within advanced industrial economies. In deprived neighbourhoods, the vast majority of the research reveals *that the level of informal work is smaller in magnitude* than elsewhere. However, this does not mean that it is less important. Informal work is actually of greater significance in these circumstances. People living in deprived neighbourhoods *rely on informal work to a far greater extent in their household coping practices to fulfil their needs and wants*.

However, the problem is that they are often less able to participate in such activity than their counterparts in more affluent neighbourhoods.

Generalisations concerning patterns of movement into, within and out of informal economic activity in deprived neighbourhoods are difficult to make given their complex and diverse constitution within particular places. Factors including *gender, ethnicity, age/lifecycle, employment status and migrant status*, impact upon engagement with different forms of informal work in different neighbourhoods, although knowledge on these issues remains very limited. However certain generalisations can be made:

- With respect to *gender*, women are especially important within the realm of self-provisioning and mutuality, and undertake a particular role in certain types of paid informal work (childcare, cleaning, care work) and illegal work (prostitution and sex work). By contrast male labour dominates certain areas of paid informal work (eg construction), and involvement in illegal economic activity is predominantly male and concerned with drugs, tobacco, alcohol, and people trafficking.

- In terms of *age/lifecycle*, young males are particularly important with regards to illegal economic activity and much less involved in self-provisioning and mutual aid activities, whilst the elderly are more likely to be engaged in mutual aid activity.
- The 'official' *unemployed* are less likely to be involved in any of areas of informal economic activity compared to other groups.
- There is significant variation in engagement in informal economic activity between different *ethnic* groups. For *immigrants* there is a propensity to become involved in paid informal work and illegal working, often due to their legal status and marginalised labour market position. The poorest immigrants, asylum seekers and refugees, also rely heavily upon self-provisioning. Immigrant and ethnic groups have also become more associated with specific illegal economic activities and organised crime that exploits cross border contacts to facilitate the international movement of different goods and services.

Similar care is also needed in generalising about the different types of informal economic activities and their relationship to deprived neighbourhoods. It is not possible to identify simple causal relationships, as the nature and type of activity is embedded within distinct contexts. However, certain general patterns can be identified with respect to different types of informal work:

- *Paid Informal Work* of an independent nature is less prevalent in deprived neighbourhoods due to lower levels of demand and supply, and the relative weakness of the formal economy. Where it does occur, it is more likely to be conducted for reasons of cash mediated reciprocity.
- *Illegal Economic Activity* has a complex relationship with deprived neighbourhoods variously ascribed to marginalisation or culture of poverty arguments. The central hub of illegal economic activity appears to revolve around drug markets, whether local or national.
- *Unpaid Informal Work* includes both self-provisioning, which is driven by economic necessity more than choice and restricted by resources and skills, and Mutual Aid, where the cultures of participation are different to more affluent neighbourhoods. In deprived neighbourhoods mutual aid is intimately connected to coping and is more informal and one-to-one based than the group orientations more prevalent in better off neighbourhoods.

## Informal economic activities as both a negative and positive force for economic activity within deprived neighbourhoods

Many informal economic activities are characterised by fundamental contradictions that ensure they can contribute in both a positive and negative manner to processes of local economic development. To identify 'positive' consequences of informal economic activity is neither to condone nor suggest

the promotion of such activities; it is merely to indicate certain consequences, which could be interpreted as positive for the individuals involved. Positive and negative impacts at the level of the neighbourhood or community are also identifiable.

The negative consequences of informal economic activities are most apparent with respect to illegal economic activity and, to a lesser extent, paid informal work. For illegal economic activity negative consequences outweigh any positive benefits. However, paid informal work is probably the most contentious area due to its intimate relationship with formal economic activity. Activity of this type can clearly be highly damaging to formalised activities (eg via unfair competition; displacement effects), but also offers important complementarities and flexibility, and can encourage entrepreneurial activity and skills development.

The positive consequences of informal economic activities are most apparent and at their least contentious in the realm of self-provisioning and mutual aid. The ability of these actions to help meet basic needs and contribute to survival strategies, to keep local populations active and engaged, and develop stocks of social capital are all particularly important within deprived neighbourhoods.

In evaluating the balance between negative and positive consequences, an important distinction can be made between dependent and independent informal economic activities. Negative consequences are at their most severe with respect to 'dependent' informal economic activity, where either formal (firms) or informal (criminal gang) institutions operate informally in order to exploit workers and evade the processes of law. In contrast, 'independent' informal economic activity is often closely aligned to the pursuit of survival strategies in a manner which often displays what are considered positive virtues of self-reliance, initiative taking, engagement and entrepreneurialism. However, there are many relationships between dependent and independent activities which mean that, at times, the clarity of this distinction is difficult to maintain.

## Impacts of current policies and regulations upon the operation of informal economic activity in deprived neighbourhoods

Current policies from government departments on informal economic activity derive from a *desire to reduce paid informal work* (Department of Work and Pensions, Inland Revenue, Customs and Excise). However, there is also evidence of a more ambivalent view where such activities might *help tackle problems of social exclusion* (Small Business Service, Active Communities Unit, Social Exclusion Unit, Neighbourhood Renewal Unit). The tendency, post-Grabner, has been for the former policies to reduce benefit fraud and tax evasion to predominate over those tackling social exclusion.

Some policy initiatives have emerged from the social inclusion agenda that seek to *formalise informal economic activity* (eg Back to Work Bonus, Test Trading, Twin Tracking, use of Phoenix Fund for projects to facilitate formalisation).

However, there is very little evidence of recent policies that have specifically sought to either shift informal activity into the formal sector, or promote such activity as the basis for an improved quality of life or an alternative to formal employment. Where such policies have existed there is little by way of formal evaluations of them.

## Challenges and opportunities for further policy development

Informal economic activity is an *integral part* of the overall economy in deprived neighbourhoods and will continue to be so in the future. Previous modernisation perspectives conceived of informal economic activity as residual activity that will eventually disappear. Evidence suggests that contemporary processes of economic globalisation, flexibilisation and the reconfiguring of state activity have further stimulated the *growth of informal work*. In policy terms this reality needs to be recognised, as does a broad view of what constitutes informal economic activity.

For deprived neighbourhoods informal economic activity is a *major resource* in areas where resources are in short supply. The challenge therefore is whether and how to *build upon the positive elements in such a manner that complements efforts to tackle the negative aspects of informal economic activity*. For policies to be effective they need to be *adapted to local conditions* and contexts. However, establishing adequate knowledge about the nature and extent of informal economic activity within given localities for this purpose is problematic.

Strategies to address the negative impacts of informal economic activity might *focus upon the more draconian measures where the negative impact is greatest*. Greatest negative impact occurs where dependent or semi-independent informal economic activity is heavily connected to larger organisations, such as formal legitimate businesses or illegal organised criminal gangs. These areas of activity involve substantial sums and losses to the taxpayer. The current policy framework does much to address the negative impacts of this type of informal economic activity.

For strategies to promote the positive consequences of informal economic activity, the guiding principle is to find ways to positively promote the advantage of engagement in the remaining range of economic activity without unduly affecting the competitiveness of formal economic activity or creating an excessive financial burden on the state. Such strategies might include schemes to encourage *mutuality and social capital*, (eg Local Exchange Trading Systems or 'LET' schemes, Time Banks) *acquire skills* (eg for self-provisioning), *develop entrepreneurial skills* (eg via formalisation schemes), *promote active citizenship* (eg via a tax credit system) and improve the *ability to cope* of those living in deprived neighbourhoods. Much of the current policy framework concerning informal economic activity does not address the potential positive impacts for disadvantaged neighbourhoods.